

+ BEARING REPLACEMENT GUIDE



SUBSCRIBE TO NSK NEWSLETTER 





Table of Contents

About NSK	4
Engineering Section	
Technical Information	7
Terminology	8
Bearing Types and Performance	9
Internal Clearance	10
Precision Class	11
Bearing Lubrication	12
Care & Maintenance	15
Inspection Bearing Failures	22
Replacement Bearings	24
Bearings Selection	
Selection by Dimensions (Metric)	28
Selection by Dimensions (Inch)	102
Interchange List	110
Bearings Tables	
Ball Bearings	122
Extra Small Bearings	138
Maximum Type Ball Bearings	139
Double Row Deep Groove Ball Bearings	140
Single Row Angular Contact Ball Bearings	144
Double Row Angular Contact Ball Bearings	152
Duplex Ball Bearings (4 Contact Points)	156
Self-Aligning Ball Bearings	162
Cylindrical Roller Bearings	170
Tapered Roller Bearings	186
Spherical Roller Bearings	218
Thrust Bearings	228
Accessories	244
Super Precision Bearings	253
Other Product Ranges	261

As one of the world's leading manufacturers of rolling bearings, linear technology components and steering systems, we can be found on almost every continent – with production facilities, sales offices and technology centres – because our customers appreciate short decision-making channels, prompt deliveries and local service.



The NSK company

NSK commenced operations as the first Japanese manufacturer of rolling bearings back in 1916. Ever since, we have been continuously expanding and improving not only our product portfolio but also our range of services for various industrial sectors. In this context, we develop technologies in the fields of rolling bearings, linear systems, components for the automotive industry and mechatronic systems. Our research and production facilities in Europe, Americas and Asia are linked together in a global technology

network. Here we concentrate not only on the development of new technologies, but also on the continuous optimisation of quality – at every process stage.

Among other things, our research activities include product design, simulation applications using a variety of analytical systems and the development of different steels and lubricants for rolling bearings.

Partnership based on trust – and trust based on quality

Total Quality by NSK: The synergies of our global network of NSK Technology Centres. Just one example of how we meet our requirements for high quality.

NSK is one of the leading companies with a long tradition in patent applications for machine parts. In our worldwide research centres, we not only concentrate on the development of new technologies, but also on the continual improvement

of quality based on the integrated technology platform of tribology, material technology, analysis and mechatronics.

More about NSK at www.nskeurope.com or call us on +44 (0)1636 605123



Technical Information

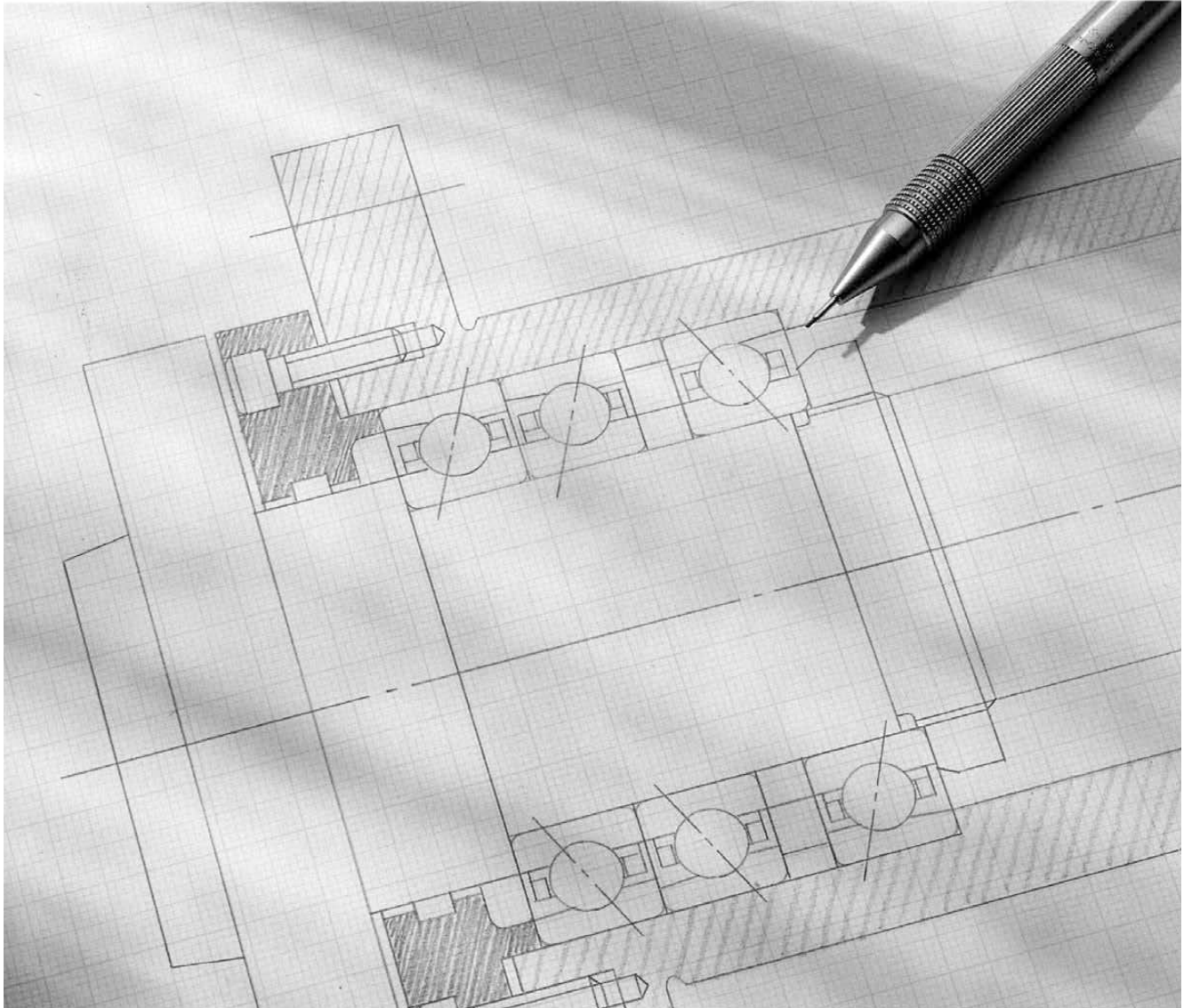

Technical Information

Terminology	8
Bearing Types and Performance	9
Internal Clearance	10
Precision Class	11
Bearing Lubrication	12
Care & Maintenance	15
Inspection, Bearing Failures	22
How to Order Replacement Bearings	24

Terminology

Design and Classification

Rolling bearings use balls or other rolling elements, located between bearing rings, to minimize friction. The rolling elements are separated and held in position by “cages” or other retaining devices.

The construction of six of the most common rolling element bearings are illustrated here for identification of nomenclature. Specific dimensions and details for these bearings are given in the dimensional tables in the following sections of this catalog.

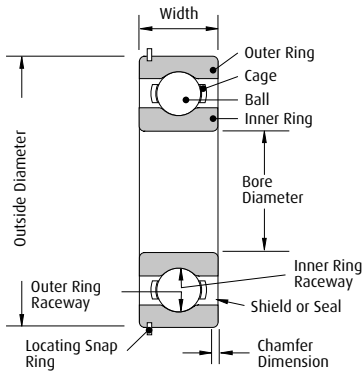

Single Row Deep Groove Ball Bearing

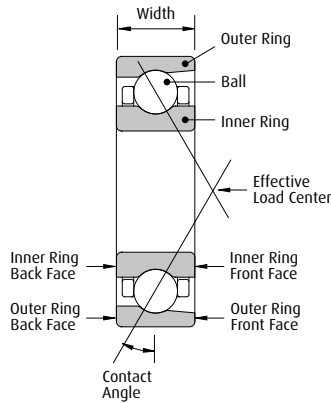

Single Row Angular Contact Ball Bearing

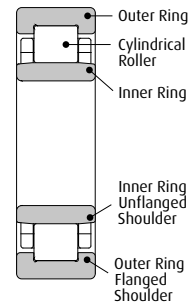

Cylindrical Roller Bearing (NU Style)

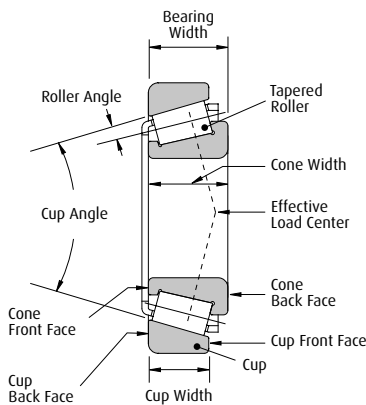

Tapered Roller Bearing

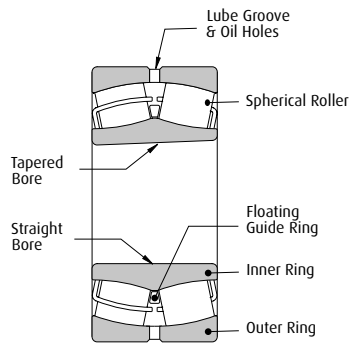



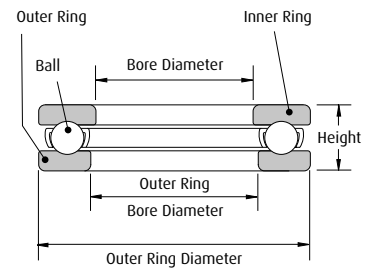





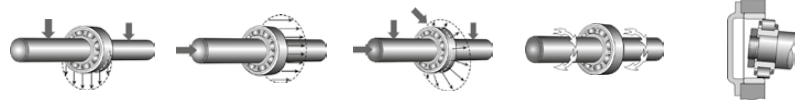



Spherical Roller Bearing



Single Direction Thrust Ball Bearing

Bearing Types and Performance



Bearing Type	Series	Radial Loads	Axial Loads	Combined Loads	High Speeds	Angular Misalignment
 Deep groove ball bearing	600-6000-6200-6300-16000-16100-6800-6900-BL	Good	Fair 2 directions	Good	Excellent	Good
 Double row deep groove ball bearing	4200-4300	Good	Fair 2 directions	Fair	Fair	Poor
 Angular contact ball bearing	7200-7300	Good	Good 1 direction only	Good	Excellent	Poor
 Double row angular contact ball bearing	3200-3300-5200-5300	Good	Good 2 directions	Good	Fair	Poor
 Four-point contact ball bearing	QJ200-QJ300	Poor	Good 2 directions	Fair	Good	Poor
 Self-Aligning Ball bearing	1200-1300-2200-2300	Fair	Poor 2 directions	Poor	Good	Excellent
 Cylindrical Roller bearing	NU-N200-300-400-1000-2200-2300	Good	None	None	Excellent	Fair
 Cylindrical Roller bearing	NJ-NF200-300-400-1000-2200-2300	Good	Fair 1 direction only	Fair	Good	Fair
 Cylindrical Roller bearing	NUP200-300-400-1000-2200-2300	Good	Fair 2 directions	Fair	Good	Fair
 Tapered Roller bearing	HR30200-30300-30300DJ-32000-32200-32300-33000-33100-33200	Good	Good 1 direction only	Good	Fair	Fair
 Spherical Roller bearing	21300-22200-22300-23000-23100-23200-23900-24000-24100	Excellent	Fair 2 directions	Good	Fair	Excellent
 Thrust Ball bearing	51100-51200-51300-51400-52200-52300-52400	None	Good 1 direction only	None	Poor	None

Bearing Internal Clearance

Internal Clearances and Standards

Bearing internal clearance is the total clearance between the rings and rolling elements. Internal clearance influences fatigue life, vibration, noise, and operating temperature. Therefore, selection of the proper clearance is critical. Radial and axial clearances are defined as the total amount that one ring can be displaced relative to the other in either the radial or axial direction as shown in this drawing. To obtain accurate measurements for ball bearings, internal clearance is usually measured by applying a specified

measuring load to the bearings. The clearance measured is always slightly larger than the actual bearing internal clearance due to the elastic deformation caused by the measuring load.

Actual internal clearance is obtained by correcting the measured clearance by the amount of elastic deformation. In the case of roller bearings this elastic deformation is negligible. Bearing internal clearances listed throughout this catalog have been corrected to provide actual internal clearances.

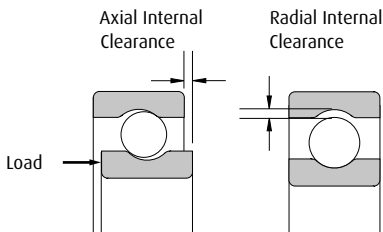

Radial Internal Clearance

Example of Radial Internal clearances for a single row radial ball bearing with a bore diameter between 24 and 30 mm.

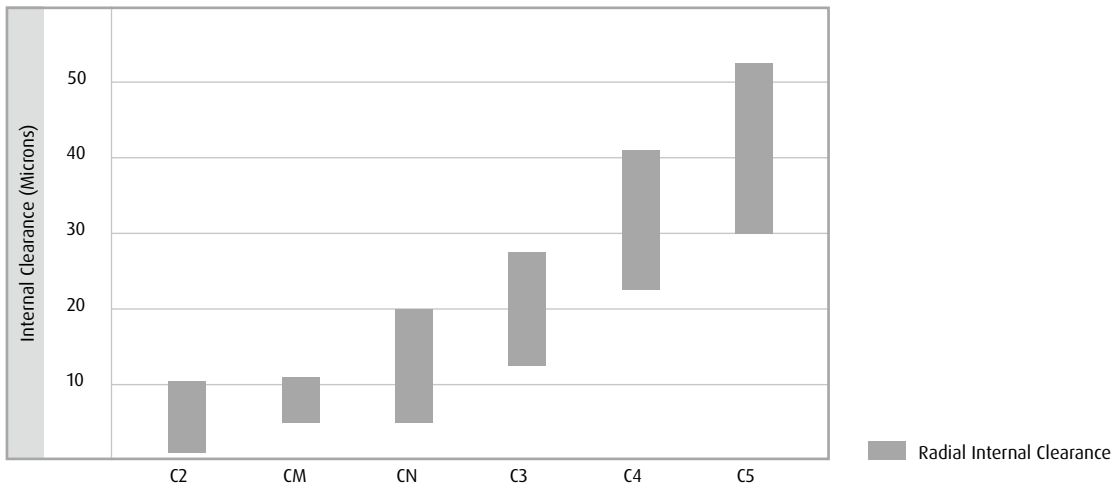

Radial Internal Clearances Table for each type of Bearing is presented before each Bearing type table.

Precision Class

Bearing Tolerance Standards

The dimensional and running accuracies of rolling bearings are standardized by ISO with regard to the following items:

- › Tolerances for bore diameter, outer diameter, individual ring width, and overall width
- › Tolerances for absolute dimensions of inscribed circle diameter and circumscribed circle diameter
- › Tolerances for chamfer dimension
- › Tolerances for width variations
- › Tolerances for taper angle and taper bore diameters
- › Tolerances for radial runout of inner ring and outer rings
- › Tolerances for axial runout of inner and outer rings
- › Tolerances for side or face runout of inner ring
- › Tolerances for side or face runout of outer ring

Precision Standards

Equivalent standards (reference)	JIS ⁽¹⁾ DIN ⁽²⁾	Class 0 P0	Class 6 P6	Class 5 P5	Class 4 P4	Class 3 P3	Class 2 P2
ANSI/ABWA ⁽³⁾	Ball Bearings	ABEC 1	ABEC 3	ABEC 5 (CLASS 5P)	ABEC 7 (CLASS 7P)	ABEC 7/9	ABEC 9 (CLASS 9P)
	Roller Bearings	RBEC 1	RBEC 3	RBEC 5			
	Tapered Roller Bearings	CLASS 4	CLASS 2	CLASS 3	CLASS 0		CLASS 00

⁽¹⁾ JIS: Standards for Japanese Industry, ⁽²⁾ DIN: German Institute for Standards, ⁽³⁾ ABMA: American Bearing Manufacturers Association.

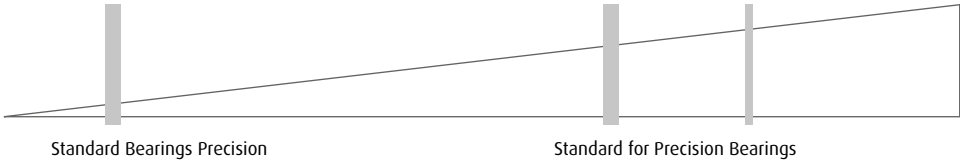

Bearing Lubrication

Lubrication - the Purpose

Lubrication is needed to reduce friction and wear inside the bearing. Proper lubrication and procedures will allow the bearing to reach its expected life.

Primarily, lubrication serves the following purposes:

- › Reduces Friction and Wear – Direct metallic contact between the bearing rings, rolling elements and cage is prevented by an oil film which reduces the friction and heat at the contact areas.
- › Extends Bearing Life – The rolling fatigue life of bearings depends in a large part on the viscosity and film thickness of the lubricant. A heavy film thickness prolongs the bearing fatigue life.
- › Cooling – Circulating oil can be used to carry heat away from the bearing. A circulating system is normally used when excessive heat is generated by the bearing due to high speeds, high loads, or when heat from a source adjacent to the bearing can affect its operation. Oils deteriorate at high temperatures; therefore it is important to keep both the oil and the bearing cool.
- › Other Purposes – Proper lubrication also helps to prevent foreign material from entering the bearings, and protects against corrosion or rusting.

Main Lubrication Methods

Lubrication can be accomplished by using either oil or grease. The most satisfactory bearing performance will be achieved by selecting the method most suitable for a specific application.

This of course will also depend on the conditions under which the bearing will operate.

Oil lubrication is superior in lubricating efficiency, however, grease lubrication allows a simpler structure around the bearings.

The following table compares oil and grease lubrication.

Grease Lubrication

Grease is a semi-solid lubricant of a base oil and a thickener. Other ingredients are sometimes added to impart special properties to the base.

Additives – Grease often contains a variety of additives such as antioxidants, corrosion inhibitors, and extreme pressure additives to give it special properties.

Extreme pressure additives are recommended for use in heavy load applications. For long use without replenishment, an antioxidant should be added.

Consistency – Consistency indicates the “softness” of the grease. The following table shows the relationship between consistency and working conditions.

In general, grease of different types must not be mixed. Mixing grease with different types of thickeners may destroy the composition and physical properties of the grease. Even if the thickeners are of the same type, possible differences in the additives may cause detrimental effects.

Operating Factor	Grease Lubrication	Oil Lubrication
Housing Structure and Sealing Method	Simple	May be complex. Careful maintenance required
Speed	Limiting speed is 65% to 80% of that of oil lubrication	High limiting speed
Cooling Effect	Poor	Heat transfer is possible using forced oil circulating lubrication
Fluidity	Poor	Good
Full Lubricant Replacement	Sometimes difficult	Easy
Removal of Foreign Matter	Removal of particles from grease is impossible	Easy
External Contamination Due to Leakage	Surroundings seldom contaminated by leakage	Often leaks without proper countermeasures. Not suitable if external contamination must be avoided

Consistency Number [Given by the National Lubricating Grease Institute (NLGI) Scale]

	0	1	2	3	4
Consistency ⁽¹⁾ (1/10 mm)	385-355	340-310	295-265	250-220	205-175
Working Condition	For centralized oiling. When false brinelling is liable to occur.	For centralized oiling. When fretting is liable to occur. For low temperature.	For general use. For sealed bearings.	For high temperature. For general use. For sealed bearings.	For high temperature. For grease seals.

⁽¹⁾ Consistency: Depth into grease attained by a cone when pressed with a specified weight, indicated in units of 1/10 mm. The larger the value, the softer the grease.

Grease Quantity

The quantity of grease to be packed in a housing depends on the housing design, rotational speeds of the bearings, characteristics of the grease selected, and the ambient temperature conditions. These factors are critical to satisfactory performance.

In applications where the operating speed does not exceed one-half the rated limiting speed of the bearing, the bearing should be packed one-half to two-thirds full.

If the speed of the bearing exceeds one-half the limiting speed, the quantity of grease should be reduced to one-third to one-half full and periodic regreasing scheduled.

When operating conditions are not severe, the original pack of grease should last a long time without replenishment.

If the operating conditions become severe, it will be necessary to regrease periodically.

Care should be taken to avoid excessive greasing as this will cause bearings to overheat.

Grease Replenishment

Frequent grease replenishment is required when operating conditions are severe such as in high ambient temperatures or where contaminants can enter bearing housings. Routine regreasing schedules should be established. In cases where extremely severe conditions exist or the bearings are in a remote area, the bearing housing should be designed to make replenishment and replacement as simple as possible.

Automatic grease systems are available and should be used. For normal operating conditions, it may be necessary to regrease the bearing periodically to replace any grease which has leaked from the housing and to eliminate any

deteriorated grease.

Even if high-quality grease is used, there is deterioration of its properties with time; therefore, periodic replenishment is required. Figs 12.2 (1) and (2) show the replenishment time intervals for various bearing types running at different speeds. Figs.12.2 (1) and (2) apply for the condition of high-quality lithium soap-mineral oil grease, bearing temperature of 70°C, and normal load (P/C=0.1).

Temperature

If the bearing temperature exceeds 70°C, the replenishment time interval must be reduced by half for every 15°C temperature rise of the bearings.

Grease

In case of ball bearings especially, the replenishing time interval can be extended depending on used grease type. (For example, high-quality lithium soap-synthetic oil grease may extend about two times of replenishing time interval shown in Fig.12.2 (1). If the temperature of the bearings is less than 70°C, the usage of lithium soap-mineral oil grease or lithium soap-synthetic oil grease is appropriate.)

It is advisable to consult NSK.

Load

The replenishing time interval depends on the magnitude of the bearing load. Please refer to Fig.12.2 (3).

If P/C (P=Bearing Load, C=Dynamic Load Rating) exceeds 0.16, it is advisable to consult NSK.

Bearing Lubrication

(1) Radial Ball Bearings (a), Cylindrical Roller Bearings (b)

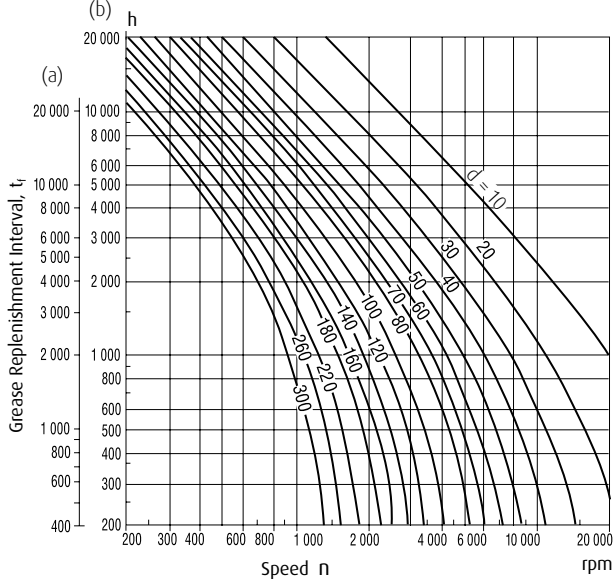

(2) Tapered Roller Bearings, Spherical Roller Bearings

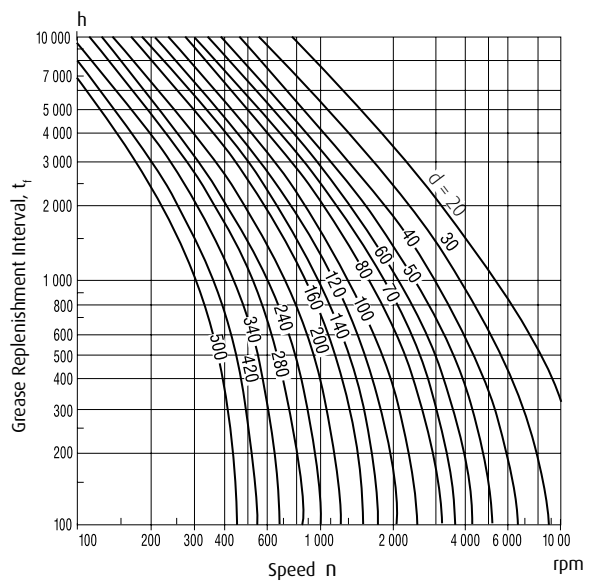

(3) Load factor

P/C^*	≤ 0.06	0.1	0.13	0.16
Load factor	1.5	1	0.65	0.45

*P=Bearing Load, C=Dynamic Load Rating

Oil Lubrication

When the operating speed exceeds the grease limiting speed listed for the bearing, oil lubrication should be used. Several methods are available and are described below. The best method to use will depend on operating conditions.

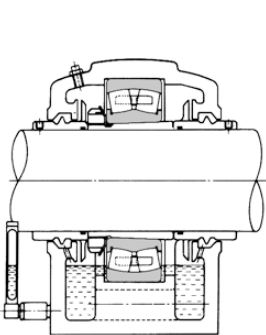

Oil Bath Lubrication:
not for high speeds

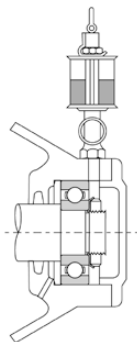

Drip Feed Lubrication:
for high speeds

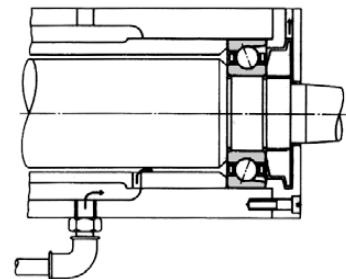

Oil Mist Lubrication:
high speeds to ultra high speeds

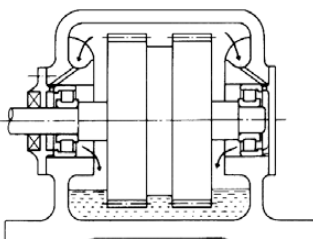

Splash Lubrication:
gearboxes

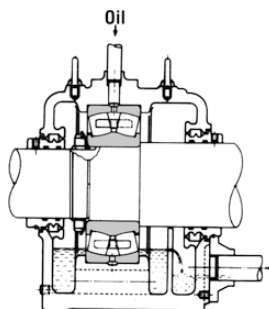

Circulating system lubrication:
high speeds and high temperature

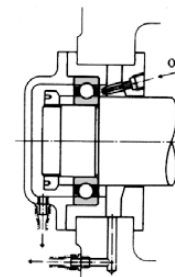

Jet Lubrication:
ultra high speeds, like jet engine or machine tool spindles

Care and Maintenance

How to Handle Bearings

Rolling bearings are high precision machine parts and need to be handled carefully. When installing or removing a bearing, correct procedures should be followed. Careless handling during mounting and removal could result in a serious accident, injuring people and damaging property.



Mounting-Factors To Consider

Bearings are very precise and their mounting requires careful attention. The following items must be considered:

- › Cleaning related parts
- › Dimensions and finish of related parts
- › Mounting procedures
- › Inspection after mounting
- › Supply of lubricants

Bearing mounting methods depend on bearing type and the type of fit. As bearings are usually used with rotating shafts, the inner rings require a tight fit. Bearings with cylindrical bores are usually mounted by pressing through the inner ring on the shafts (press fit) or heating them to expand their diameter (shrink fit). Bearings with tapered bores can be mounted directly on tapered shafts or on cylindrical shafts by using tapered sleeves.

Bearings are usually mounted in housings with a loose fit. However, if the outer ring has an interference fit, a press may be used. Bearings can be interference fitted by cooling before mounting, using dry ice. If this is done, a rust preventive treatment must be applied to the bearings because moisture in the air will condense on bearing surfaces.

Mounting Bearings With Cylindrical Bores

Before fitting bearings:

- › Leave preservative oil on bearing
- › Compatible with most oils and greases
- › Provides complete protection until run
- › Only remove preservative oil when bearing is to be used with special oils or greases

Care and Maintenance

Press Fit

Press or Tubular Drift Fits

Fitting Bearing into Housing

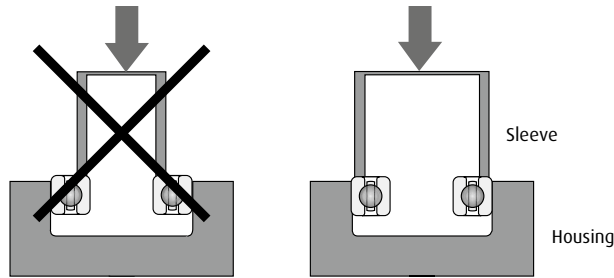

Fitting Bearing to Shaft

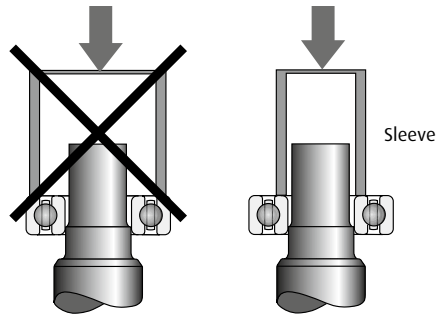

Shrink Fits

Shrink fitting is often used to avoid the large force involved in press fitting large bearings. This method eliminates the need to impose excessive force on the bearings. For shrink fitting, the bearings are first heated in oil, or in an induction heater, to expand them, then mounted and allowed to cool.

This amount of expansion of the inner ring for various temperature differences and bearing sizes are shown in Figure 1.

Figure 1: Temperature and Expansion of Inner Ring

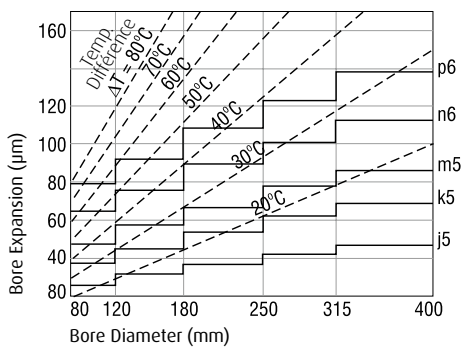

Bearing Heater

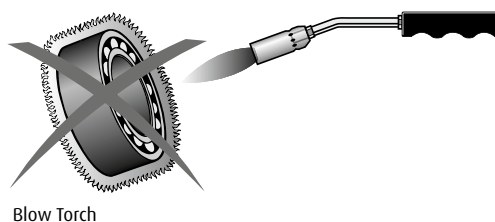

Blow Torch

Heating Bearing in Oil

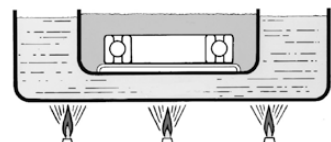

Oil 90-99°C - Water 100°C

A few precautions to be considered when making shrink fits:

- › Do not heat bearings to more than 120°C.
- › Put bearings on a wire netting or suspend them in the oil tank to prevent them from touching the tank bottom.
- › Heat bearings to a temperature 20 to 30°C higher than the lowest temperature required for mounting, because the inner ring will cool a little during mounting

After mounting, the bearings will shrink in the axial direction as well as the radial direction while cooling. Therefore, while mounting, press the bearing firmly against the shaft shoulder to avoid excessive clearance between the bearing and the shoulder.

Mounting Bearings with Tapered Bores

Large spherical bearings are often mounted using hydraulic pressure. Figure 1 shows two different hydraulic mounting methods. One method is a sleeve with a hydraulic nut. The other method uses a sleeve with pressurized oil.

Holes drilled in the sleeve are used to feed oil under pressure to the bearing seat. As the bearing expands radially, the sleeve is inserted axially with adjusting bolts.

Figure 1

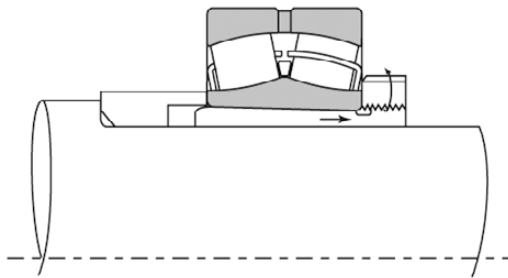

Mounting w/Adapter

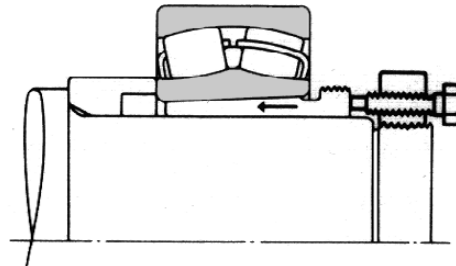

Mounting with Withdrawal Sleeve

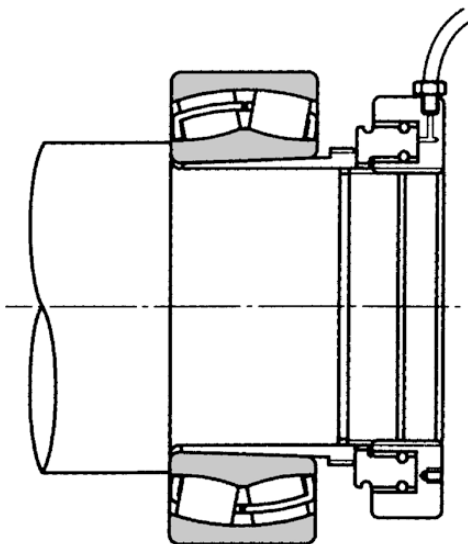

Mounting with Hydraulic Nut

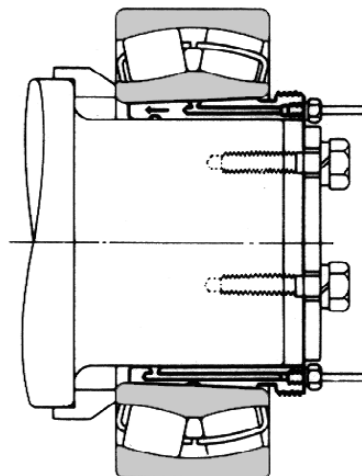

Mounting w/Special Sleeve and Pressurized Oil

Care and Maintenance

The internal clearance of a tapered bore bearing varies with the tightness of the interference fit. It is necessary to check the clearance often as the bearing is being mounted. The bearing should be pressed until the reduction of radial clearance is within the range shown in Table (1) on page 19.

Radial internal clearance can be measured during mounting using a feeler gauge or other appropriate gauges. In this process, the clearances for both rows of rollers must be measured simultaneously and the two values kept roughly the same by adjusting the relative position of the outer and inner rings. This is shown in Fig. 1. The average of the two measurements taken for both rows may be used as the residual internal clearance.

In large bearings, the outer ring may deform slightly into an elliptical shape due to its own weight. In this case, for best results, measurements should be taken at locations a, b, and c (see Fig. 3) and entered into the following equation:

$$\text{Radial Clearance} = (a + b + c) / 2$$

This method is used where the bearing is resting on its inner ring (radial clearance c at bottom). When a self-aligning ball bearing is mounted on a shaft adapter, sufficient clearance for easy alignment of the outer ring must be allowed.

Figure 2

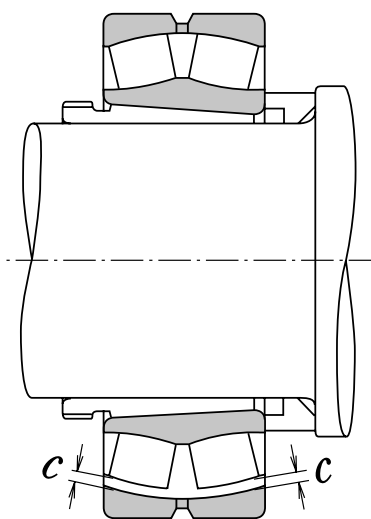
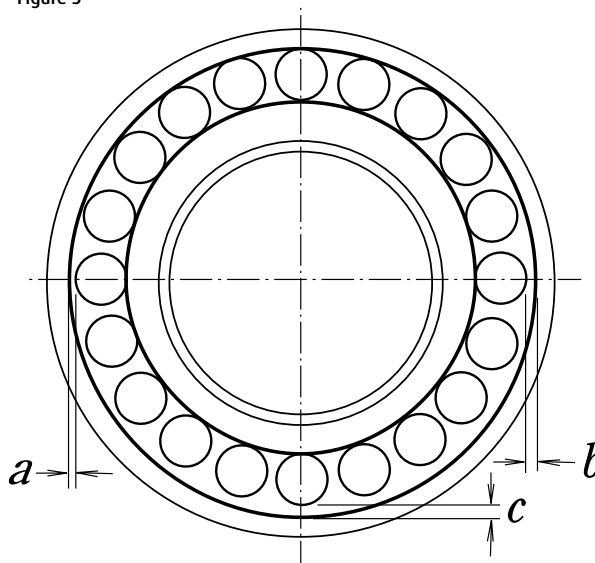

Figure 3



(1) Mounting of Spherical Roller Bearings with Tapered Bores

Bearing Bore Diameter <i>d</i>		Reduction in Radial Clearance		Axial Movement				Minimum Permissible Residual Clearance	
over	incl	min.	max.	Taper 1:12		Taper 1:30		CN	C3
				min.	max.	min.	max.		
30	40	0,025	0,030	0,40	0,45	-	-	0,010	0,025
40	50	0,030	0,035	0,45	0,55	-	-	0,015	0,030
50	65	0,030	0,035	0,45	0,55	-	-	0,025	0,035
65	80	0,040	0,045	0,60	0,70	-	-	0,030	0,040
80	100	0,045	0,055	0,70	0,85	1,75	2,15	0,035	0,050
100	120	0,050	0,060	0,75	0,90	1,9	2,25	0,045	0,065
120	140	0,060	0,070	0,90	1,1	2,25	2,75	0,055	0,080
140	160	0,065	0,080	1,0	1,3	2,5	3,25	0,060	0,100
160	180	0,070	0,090	1,1	1,4	2,75	3,5	0,070	0,110
180	200	0,080	0,100	1,3	1,6	3,25	4,0	0,070	0,110
200	225	0,090	0,110	1,4	1,7	3,5	4,25	0,080	0,130
225	250	0,100	0,120	1,6	1,9	4,0	4,75	0,090	0,140
250	280	0,110	0,140	1,7	2,2	4,25	5,5	0,100	0,150
280	315	0,120	0,150	1,9	2,4	4,75	6,0	0,110	0,160
315	355	0,140	0,170	2,2	2,7	5,5	6,75	0,120	0,180
355	400	0,150	0,190	2,4	3,0	6,0	7,5	0,130	0,200

The values for reduction in radial internal clearance are for bearings with CN clearance.

For bearing with C3 Clearance, the maximum values listed should be used for the reduction in radial internal clearance.

Units: mm

Inspecting and Troubleshooting

After mounting has been completed, a running test should be conducted to determine that the bearing has been mounted properly. Possible causes and countermeasures for operating irregularities are shown in Table on page 20.

Care and Maintenance

Causes and Countermeasures for Operating Irregularities

Irregularities	Possible Causes	Countermeasures
Noise Loud Metallic Sound	<ul style="list-style-type: none"> › Abnormal Load › Incorrect mounting › Insufficient or improper lubricant › Squeaking noise › Sliding of balls › Contact of rotating parts 	<ul style="list-style-type: none"> › Correction of fit, internal clearance, preload, position of housing shoulder, etc. › Correction of alignment of shaft and housing, accuracy of mounting method › Replenish lubricant or select proper lubricant › Replacement by low-noise bearings, selection of small clearance bearings › Adjustment of preload, selection of small clearance bearings, or adoption of softer grease › Correction of labyrinth seal, etc.
Loud Regular Sound	<ul style="list-style-type: none"> › Flaws, corrosion, or scratches on the raceways › Brinelling › Flaking on the raceways 	<ul style="list-style-type: none"> › Replacement of bearing, cleaning, improvement of seals, and usage of clean lubricant › Replacement of bearing and careful handling › Replacement of bearing
Irregular Sound	<ul style="list-style-type: none"> › Excessive clearance › Penetration by foreign particles › Flaws or flaking on the ball surfaces › Excessive amount of lubricant 	<ul style="list-style-type: none"> › Correction of fit and clearance and correction of preload › Replacement of bearing, cleaning, improvement of seals, and relubrication using clean lubricant › Replacement of bearing › Reduce amount of lubricant, select stiffer grease
Abnormal Temperature Rise	<ul style="list-style-type: none"> › Insufficient or improper lubricant › Abnormal load › Incorrect mounting › Creep of fitted surfaces, excessive seal friction 	<ul style="list-style-type: none"> › Replenish lubricant or select proper lubricant › Correction of fit, internal clearance, preload, position of housing shoulder › Correction of alignment of shaft and housing, accuracy of mounting, or mounting method › Correction of seals, replacement of bearing, correction of fit or mounting
Vibration	<ul style="list-style-type: none"> › Brinelling › Flaking › Incorrect mounting › Penetration by foreign particles 	<ul style="list-style-type: none"> › Replacement of bearings and careful handling › Replacement of bearing › Correction of squareness between shaft and housing shoulder or side of spacer › Replacement of bearing, cleaning, correction of seals
Leakage or Discoloration of Lubricant	<ul style="list-style-type: none"> › Too much lubrication › Penetration by foreign particles or abrasion chips 	<ul style="list-style-type: none"> › Reduce amount of lubricant, select stiffer grease. Replace bearing or lubricant › Clean housing and adjacent parts

How to dismount bearings

It may be necessary to remove bearings for periodic inspection or for other reasons. If the removed bearing is to be used again, it should be dismounted as carefully as when it was mounted. If the bearing has a tight fit, removal may be difficult. Dismounting procedures and the sequence of removal should be studied carefully before beginning the job.

Examples of method to remove a bearing

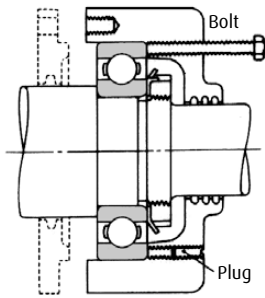

Removal of Outer Ring with Dismounting Bolts

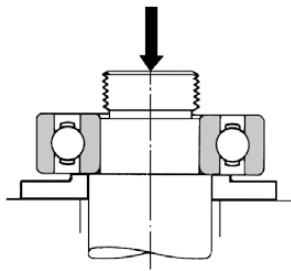

Removal of Inner Using a Press

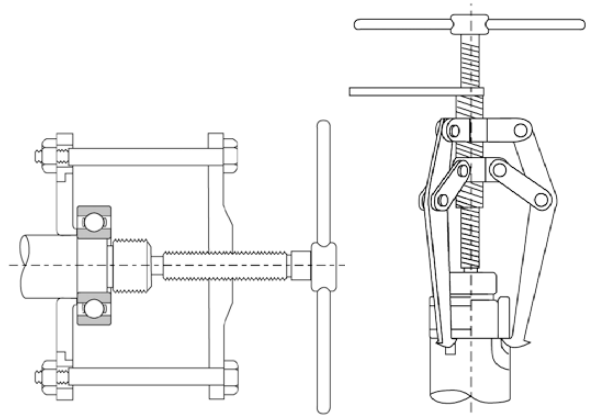

Removal of Inner Ring with Withdrawal Tools

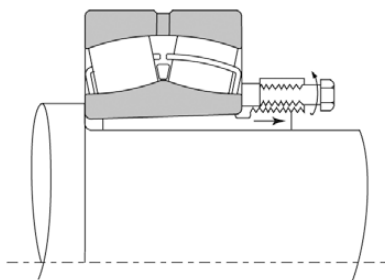

Removal of Withdrawal Sleeve with Withdrawal Nut

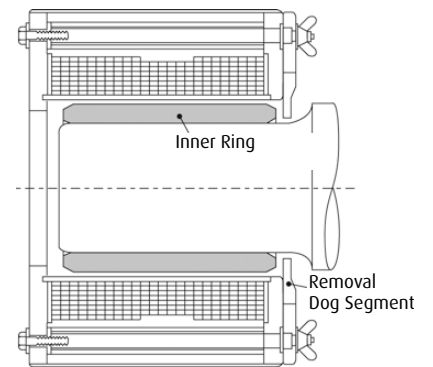
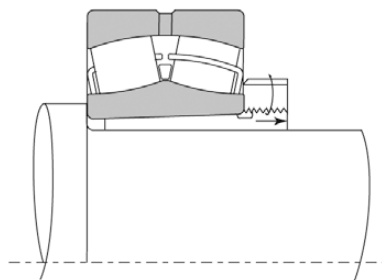

Removal of Inner Ring Using an Induction Heater

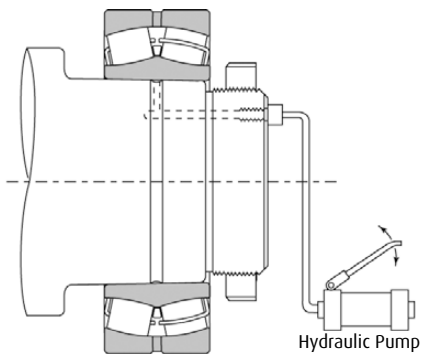

Removal Using Oil Injection

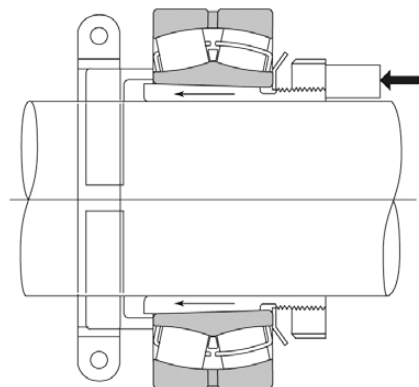

Removal of Adapter with Stop and Axial Pressure

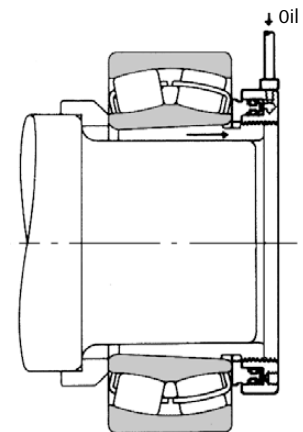

Removal Using a Hydraulic Nut

Bearing Failures

Bearing Failures - Cause and Correction

In general, if rolling bearings are correctly used, they will survive to their predicted fatigue life. Premature failure is usually caused by improper mounting or dismounting, improper lubrication, penetration of foreign material, or inadequate inspection and maintenance.



Flaking

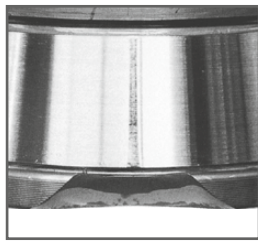

Fracture

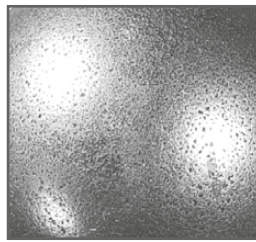

Pitting



Creep

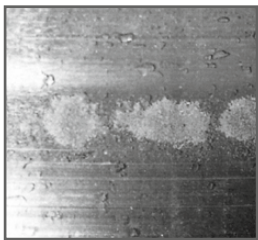

Peeling

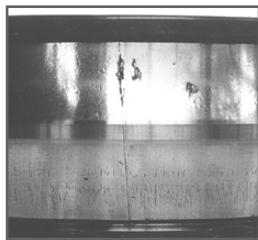

Cracks

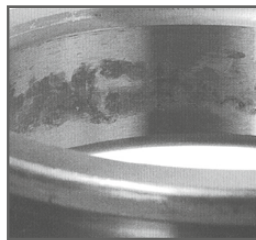

Fretting

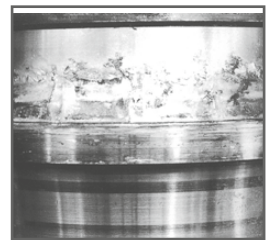

Seizure

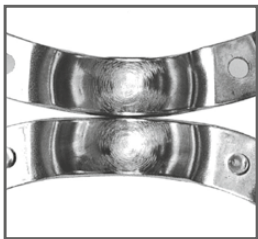

Scoring

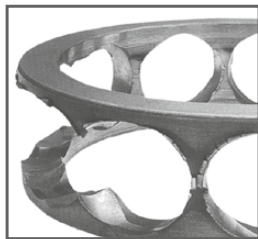

Cage Damage

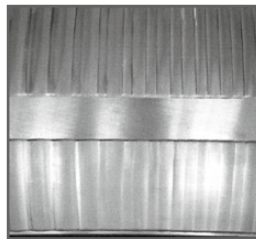

Wear

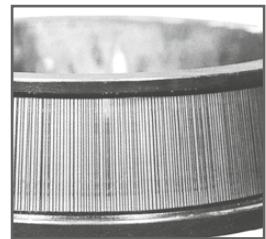

Electrical Corrosion

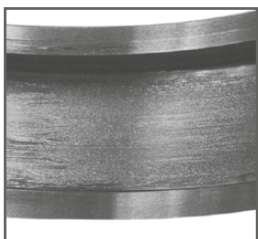

Smearing

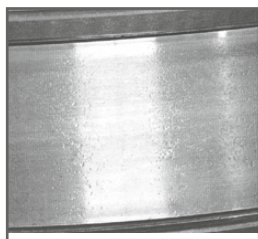

Denting

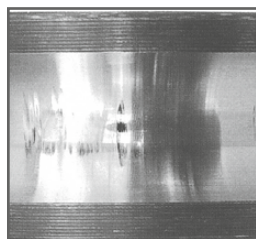

False Brinelling

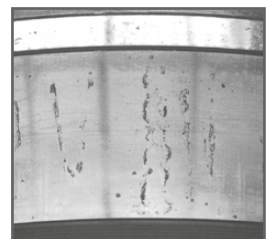

Rust and Corrosion

	Type of Failure	Probable Cause	Counter Measures
Flaking	<ul style="list-style-type: none"> › Flaking of one-side of the raceway of radial bearings. Flaking of the raceways of double row bearings › Flaking of the raceway in a symmetrical pattern › Flaking pattern inclined relative to the raceway in radial ball bearings. Flaking near the edge of the raceway and rolling surfaces in roller bearings › Flaking of raceway with same spacing as rolling elements › Premature flaking of raceways and rolling elements › Premature flaking of duplex bearing 	<ul style="list-style-type: none"> › Abnormal axial load › Out of roundness of the housing bore › Improper mounting, deflection of shaft, inadequate centering, inadequate tolerances for shaft and housing › Large shock load during mounting, rusting while bearing is out of operation for a prolonged period › Insufficient clearance, excessive load, improper lubricant, rust, etc. › Excessive preload 	<ul style="list-style-type: none"> › A loose fit should be used when mounting the outer ring of free-end bearings to allow axial expansion of the shaft › Correct the faulty housing › Use care in mounting and centering, select a bearing with a larger clearance, and correct the squareness of the shaft and housing shoulder › Use care in mounting and apply a rust preventive when machine operation is suspended for a long time › Select proper fit, bearing clearance, and lubricant › Adjust the preload
Scoring and Smearing	<ul style="list-style-type: none"> › Scoring or smearing between raceway and rolling surfaces › Spiral scoring or smearing of raceway surface of thrust ball bearing › Scoring or smearing between the end face of the rollers and guide rib 	<ul style="list-style-type: none"> › Inadequate initial lubrication, excessively hard grease and high acceleration in starting › Raceway rings are not parallel and excessive speed › Inadequate lubrication, incorrect mounting and large axial load 	<ul style="list-style-type: none"> › Use a softer grease and avoid rapid acceleration › Correct the mounting, apply a preload, or select another bearing type › Select proper lubricants and modify the mounting
Cracks	<ul style="list-style-type: none"> › Crack in outer or inner ring › Crack in rolling element. Break in rib › Fracture of cage 	<ul style="list-style-type: none"> › Excessive shock load, excessive interference fit, incorrect shaft cylindricity, improper amount of sleeve taper, large fillet radius, development of thermal cracks and advancement of flaking › Advancement of flaking, shock applied to the rib during mounting or dropped during handling › Abnormal loading of cage due to incorrect mounting and improper lubrication 	<ul style="list-style-type: none"> › Examine the loading conditions, modify the fit of bearing sleeve. The fillet radius must be smaller than the bearing chamfer › Be careful in handling and mounting › Reduce the mounting error and review the lubricating method and lubricant
Indentation	<ul style="list-style-type: none"> › Indentations on raceway in same pattern as rolling elements › Indentations on raceway and rolling elements 	<ul style="list-style-type: none"> › Shock load during mounting or excessive load when not rotating › Foreign matter such as metallic chips or sand 	<ul style="list-style-type: none"> › Use care in handling › Clean the housing, improve the seals, and use a clean lubricant
Abnormal Wear	<ul style="list-style-type: none"> › False brinelling (phenomenon similar to brinelling) › Fretting › Wearing of raceway, rolling elements, rib and cage › Creep 	<ul style="list-style-type: none"> › Vibration of the bearing without rotation during shipment or rocking motion of small amplitude › Slight wearing of the fitting surface › Penetration by foreign matter, incorrect lubrication, and rust › Insufficient interference or insufficient tightening of sleeve 	<ul style="list-style-type: none"> › Secure the shaft and housing, use oil as a lubricant and reduce vibration by applying a preload › Increase interference and apply oil › Use a different type of seal, clean the housing, and use a clean lubricant › Modify the fit or tighten the sleeve
Seizure	<ul style="list-style-type: none"> › Discoloration or welding of raceway, rolling elements, and rib 	<ul style="list-style-type: none"> › Insufficient clearance, incorrect lubrication, or improper mounting 	<ul style="list-style-type: none"> › Review the internal clearance and bearing fit, supply an adequate amount of the proper lubricant and improve the mounting method and related parts
Electric Burns	<ul style="list-style-type: none"> › Fluting or corrugation 	<ul style="list-style-type: none"> › Melting due to electric arcing 	<ul style="list-style-type: none"> › Install a ground wire to stop flow of electricity or insulate the bearing
Corrosion and Rust	<ul style="list-style-type: none"> › Rust and corrosion of fitting surfaces and bearing interior 	<ul style="list-style-type: none"> › Condensation of water from the air, fretting, or penetration by corrosive substances 	<ul style="list-style-type: none"> › Use care in storing and avoid high temperatures and high humidity; treatment for rust prevention is necessary when the operation is suspended for a long time

How to Order Replacement Bearings

Ordering the correct replacement bearing is a critical task – but one that is not difficult if you take time to gather the right information. Just follow these steps:

1. IDENTIFY – the type of bearing you need to replace.

- › Ball Bearing – Single Row, Double Row, Angular Contact
- › Roller Bearing – Cylindrical, Spherical, Tapered
- › Thrust Bearing – Ball or Roller
- › Split Pillow Block – Pillow Blocks
- › Super Precision – Angular Contact Ball, Cylindrical Roller, Ball Screw Support

2. LOCATE – the identification number on the bearing.

Bearing identification numbers are usually located on the inner ring face, outer ring face or bearing O.D. Mounted units are identified by a number tag fastened to the unit or by a housing number cast into the housing cap.

3. MEASURE – if you need to.

- › If a bearing identification number is not legible, you will need to determine the following:
 1. Inner ring bore (inside diameter)
 2. Outer ring outside diameter
 3. Inner width and outer width (these may be different)
 4. Shape of the bore and/or outside diameter of bearing – spherical, tapered or cylindrical

4. RECORD – additional relevant information.

- › The more information available, the easier it will be to identify the replacement bearing needed. Record:
 1. Unique features such as lubrication holes, snap ring grooves, machined shoulders, etc.
 2. Application/equipment data

5. LOOK – in the appropriate section of the catalog.

1. Ball Bearings
2. Cylindrical Roller Bearings
3. Spherical Roller Bearings
4. Tapered Roller Bearings
5. Thrust Bearings
6. Split Pillow Blocks
7. Super Precision Bearings

If you are still unable to identify the bearing you need, call your NSK Distribution Center.

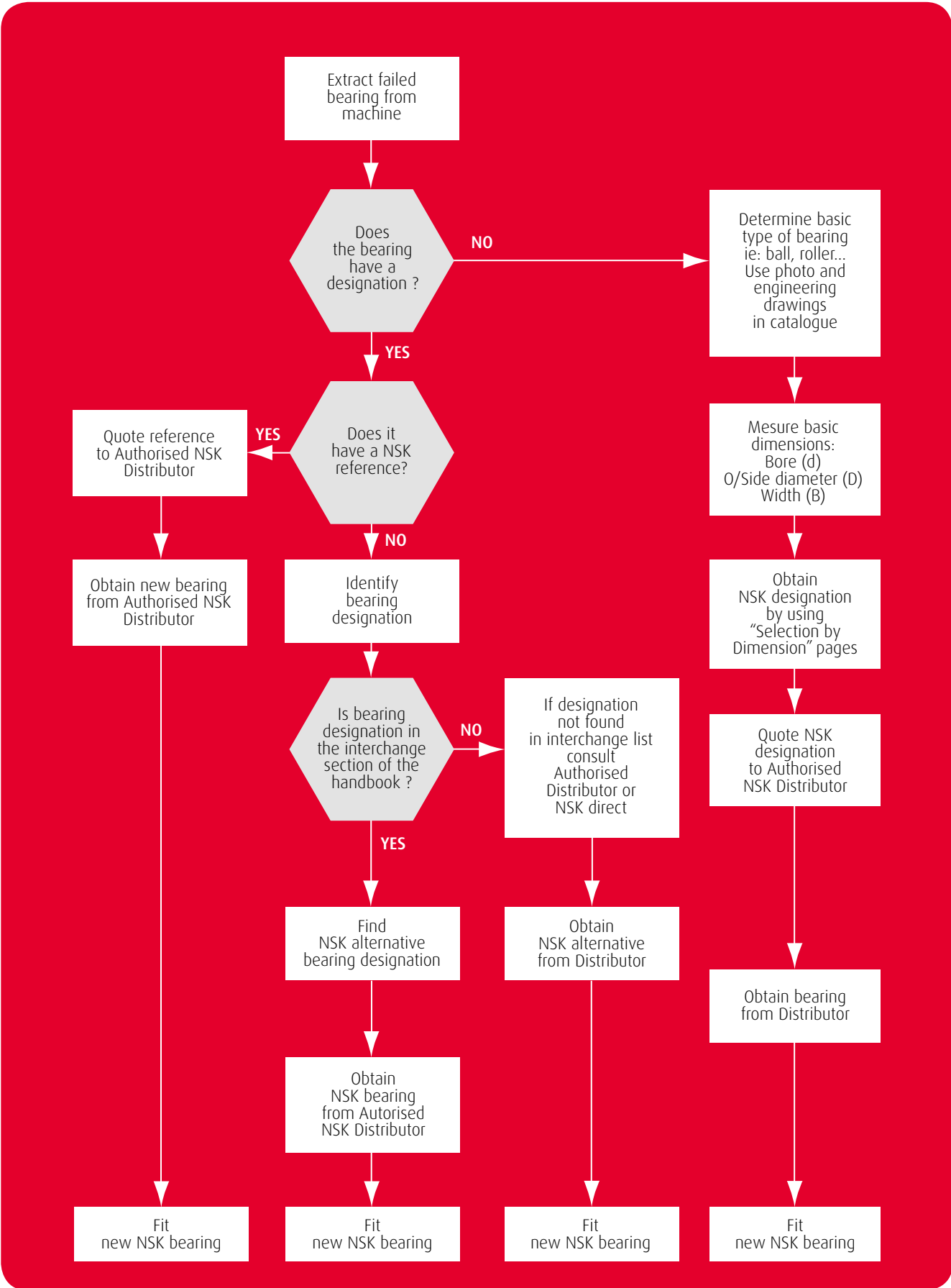

Bearings Selection



Bearings Selection

Selection by Dimensions (Metric)	28
Selection by Dimensions (Inch)	102
Interchange List	110

Selection by Dimensions (Metric)

Bore Diameter 2 – 7 mm

Bore Diameter	OD	Width	Part Number	Type	Bearing Type
2	6	3	692ZZ	B1	Single Row Radial Ball Bearings
3	10	4	623	B	Single Row Radial Ball Bearings
	10	4	623ZZ	B1	Single Row Radial Ball Bearings
4	8	4	693ZZ	B1	Single Row Radial Ball Bearings
	11	4	694ZZ	B1	Single Row Radial Ball Bearings
	12	4	604ZZ	B1	Single Row Radial Ball Bearings
5	13	5	624ZZ	B1	Single Row Radial Ball Bearings
	16	5	634DD	B2	Single Row Radial Ball Bearings
	16	5	634	B	Single Row Radial Ball Bearings
	16	5	634ZZ	B1	Single Row Radial Ball Bearings
	16	5	E4	D1	Single Row Radial Ball Bearings
6	9	4	684ZZ	B1	Single Row Radial Ball Bearings
	11	3	685	B	Single Row Radial Ball Bearings
	11	5	685ZZ	B1	Single Row Radial Ball Bearings
	13	4	695ZZ	B1	Single Row Radial Ball Bearings
	14	5	605ZZ	B1	Single Row Radial Ball Bearings
	16	5	625DD	B2	Single Row Radial Ball Bearings
	16	5	625	B	Single Row Radial Ball Bearings
	16	5	625ZZ	B1	Single Row Radial Ball Bearings
7	16	5	625ZZ	B1	Single Row Radial Ball Bearings
	16	5	E5	D1	Single Row Radial Ball Bearings
	19	6	135	G	Double Row Self Aligning Ball Bearings
	19	6	635DD	B2	Single Row Radial Ball Bearings
	19	6	635	B	Single Row Radial Ball Bearings
	19	6	635VV	B6	Single Row Radial Ball Bearings
8	19	6	635ZZ	B1	Single Row Radial Ball Bearings
	13	3,5	686	B	Single Row Radial Ball Bearings
	13	5	686DD	B2	Single Row Radial Ball Bearings
	13	5	686ZZ	B1	Single Row Radial Ball Bearings
	15	5	696DD	B2	Single Row Radial Ball Bearings
	15	5	696ZZ	B1	Single Row Radial Ball Bearings
	17	6	606DD	B2	Single Row Radial Ball Bearings
	17	6	606	B	Single Row Radial Ball Bearings
	17	6	606VV	B6	Single Row Radial Ball Bearings
	17	6	606ZZ	B1	Single Row Radial Ball Bearings
9	19	6	126	G	Double Row Self Aligning Ball Bearings
	19	6	626DD	B2	Single Row Radial Ball Bearings
	19	6	626	B	Single Row Radial Ball Bearings
	19	6	626VV	B6	Single Row Radial Ball Bearings
	19	6	626Z	B1	Single Row Radial Ball Bearings
	19	6	626ZZ	B1	Single Row Radial Ball Bearings
	21	7	E6	D1	Single Row Radial Ball Bearings
10	14	3,5	687	B	Single Row Radial Ball Bearings
	14	5	687ZZ	B1	Single Row Radial Ball Bearings
	17	5	697ZZ	B1	Single Row Radial Ball Bearings
	19	6	607DD	B2	Single Row Radial Ball Bearings
	19	6	607	B	Single Row Radial Ball Bearings
	19	6	607VV	B6	Single Row Radial Ball Bearings
11	19	6	607Z	B1	Single Row Radial Ball Bearings
	19	6	607ZZ	B1	Single Row Radial Ball Bearings
	22	7	127WA	G	Double Row Self Aligning Ball Bearings
	22	7	627DD	B2	Single Row Radial Ball Bearings
	22	7	627	B	Single Row Radial Ball Bearings

Selection by Dimensions (Metric)

Bore Diameter 7 – 10 mm

Bore Diameter	OD	Width	Part Number	Type	Bearing Type
7	22	7	627VV	B6	Single Row Radial Ball Bearings
	22	7	627Z	B1	Single Row Radial Ball Bearings
	22	7	627ZZ	B1	Single Row Radial Ball Bearings
	22	7	E7	D1	Single Row Radial Ball Bearings
8	16	4	688	B	Single Row Radial Ball Bearings
	16	5	688VV	B6	Single Row Radial Ball Bearings
	16	5	688ZZ	B1	Single Row Radial Ball Bearings
	19	6	698DD	B2	Single Row Radial Ball Bearings
	19	6	698ZZ	B1	Single Row Radial Ball Bearings
	22	7	108WA	G	Double Row Self Aligning Ball Bearings
	22	7	608DU	B2	Single Row Radial Ball Bearings
	22	7	608DD	B2	Single Row Radial Ball Bearings
	22	7	608	B	Single Row Radial Ball Bearings
	22	7	608VV	B6	Single Row Radial Ball Bearings
	22	7	608Z	B1	Single Row Radial Ball Bearings
	22	7	608ZZ	B1	Single Row Radial Ball Bearings
	24	7	E8	D1	Single Row Radial Ball Bearings
	24	8	628DD	B2	Single Row Radial Ball Bearings
	24	8	628	B	Single Row Radial Ball Bearings
	24	8	628VV	B6	Single Row Radial Ball Bearings
	24	8	628ZZ	B1	Single Row Radial Ball Bearings
	28	9	638ZZ	B1	Single Row Radial Ball Bearings
9	17	4	689	B	Single Row Radial Ball Bearings
	17	5	689ZZ	B1	Single Row Radial Ball Bearings
	20	6	699DD	B2	Single Row Radial Ball Bearings
	24	7	609DD	B2	Single Row Radial Ball Bearings
	24	7	609D	B2	Single Row Radial Ball Bearings
	24	7	609	B	Single Row Radial Ball Bearings
	24	7	609VV	B6	Single Row Radial Ball Bearings
	24	7	609Z	B1	Single Row Radial Ball Bearings
	24	7	609ZZ	B1	Single Row Radial Ball Bearings
	26	8	129WA	G	Double Row Self Aligning Ball Bearings
	26	8	629DD	B2	Single Row Radial Ball Bearings
	26	8	629	B	Single Row Radial Ball Bearings
	26	8	629VV	B6	Single Row Radial Ball Bearings
	26	8	629ZZ	B1	Single Row Radial Ball Bearings
	28	8	E9	D1	Single Row Radial Ball Bearings
10	19	5	6800	B	Single Row Radial Ball Bearings
	19	5	6800DD	B2	Single Row Radial Ball Bearings
	19	5	6800VV	B6	Single Row Radial Ball Bearings
	19	5	6800ZZ	B1	Single Row Radial Ball Bearings
	19	7	63800ZZ	B1	Single Row Radial Ball Bearings
	22	6	6900	B	Single Row Radial Ball Bearings
	22	6	6900DD	B2	Single Row Radial Ball Bearings
	22	6	6900VV	B6	Single Row Radial Ball Bearings
	22	6	6900ZZ	B1	Single Row Radial Ball Bearings
	24	9	51100	E	Thrust Ball Bearings
	26	11	51200	E	Thrust Ball Bearings
	26	16	7000ASTRDULP3	D	Super Precision Bearings
	26	16	7000ASTRDUMP3	D	Super Precision Bearings
	26	16	7000CTRDULP3	D	Super Precision Bearings
	26	16	7000CTRDUMP3	D	Super Precision Bearings
	26	8	6000	B	Single Row Radial Ball Bearings
	26	8	6000D	B2	Single Row Radial Ball Bearings
	26	8	6000DDU	B2	Single Row Radial Ball Bearings
	26	8	6000VV	B6	Single Row Radial Ball Bearings

Selection by Dimensions (Metric)

Bore Diameter 10 – 12 mm

Bore Diameter	OD	Width	Part Number	Type	Bearing Type
10	26	8	6000Z	B1	Single Row Radial Ball Bearings
	26	8	6000ZZ	B1	Single Row Radial Ball Bearings
	26	8	6000ZZNR	B4	Single Row Radial Ball Bearings
	26	8	7000BM	D	Single Row Angular Contact Ball Bearings
	28	13	53200	E1	Thrust Ball Bearings
	28	8	16100	B	Single Row Radial Ball Bearings
	28	8	E10	D1	Single Row Radial Ball Bearings
	30	14	2200J	G	Double Row Self Aligning Ball Bearings
	30	14	3200A	M	Double Row Angular Contact Ball Bearings
	30	14	3200B-2RSTN	M2	Double Row Angular Contact Ball Bearings
	30	14	3200B-2ZTN	M1	Double Row Angular Contact Ball Bearings
	30	14	3200BTN	M	Double Row Angular Contact Ball Bearings
	30	14	4200J	L	Double Row Ball Bearings
	30	14	4200BTN	L	Double Row Ball Bearings
	30	18	7200ASTRDULP3	D	Super Precision Bearings
	30	18	7200ASTRDUMP3	D	Super Precision Bearings
	30	18	7200CTRDULP3	D	Super Precision Bearings
	30	18	7200CTRDUMP3	D	Super Precision Bearings
	30	9	1200J	G	Double Row Self Aligning Ball Bearings
	30	9	6200	B	Single Row Radial Ball Bearings
	30	9	6200DDU	B2	Single Row Radial Ball Bearings
	30	9	6200DDUNR	B5	Single Row Radial Ball Bearings
	30	9	6200DU	B2	Single Row Radial Ball Bearings
	30	9	6200NR	B	Single Row Radial Ball Bearings
	30	9	6200VV	B6	Single Row Radial Ball Bearings
	30	9	6200Z	B1	Single Row Radial Ball Bearings
	30	9	6200ZNR	B4	Single Row Radial Ball Bearings
30	9	6200ZZ	B1	Single Row Radial Ball Bearings	
30	9	6200ZZNR	B4	Single Row Radial Ball Bearings	
30	9	7200BW	D	Single Row Angular Contact Ball Bearings	
30	9	7200BWG	D	Single Row Angular Contact Ball Bearings	
	32	14	LB3200B-2ZRSTN	M6	Double Row Angular Contact Ball Bearings
	32	14	LZ3200B-2ZRSTN	M7	Double Row Angular Contact Ball Bearings
	32	22	52202	N	Thrust Ball Bearings
	35	11	1300J	G	Double Row Self Aligning Ball Bearings
	35	11	6300	B	Single Row Radial Ball Bearings
	35	11	6300DDU	B2	Single Row Radial Ball Bearings
	35	11	6300DU	B2	Single Row Radial Ball Bearings
	35	11	6300VV	B6	Single Row Radial Ball Bearings
	35	11	6300Z	B1	Single Row Radial Ball Bearings
	35	11	6300ZZ	B1	Single Row Radial Ball Bearings
	35	11	7300BW	D	Single Row Angular Contact Ball Bearings
	35	17	2300J	G	Double Row Self Aligning Ball Bearings
11	32	7	E11	D1	Single Row Radial Ball Bearings
12	21	5	6801	B	Single Row Radial Ball Bearings
	21	5	6801DD	B2	Single Row Radial Ball Bearings
	21	5	6801VV	B6	Single Row Radial Ball Bearings
	21	5	6801ZZ	B1	Single Row Radial Ball Bearings
	24	6	6901	B	Single Row Radial Ball Bearings
	24	6	6901DD	B2	Single Row Radial Ball Bearings
	24	6	6901VV	B6	Single Row Radial Ball Bearings
	24	6	6901ZZ	B1	Single Row Radial Ball Bearings
	26	9	51101	E	Thrust Ball Bearings
	28	11	51201	E	Thrust Ball Bearings
	28	12	63001DDU	B2	Single Row Radial Ball Bearings
	28	12	63001ZZ	B1	Single Row Radial Ball Bearings
	28	7	16001	B	Single Row Radial Ball Bearings
	28	8	6001	B	Single Row Radial Ball Bearings

Selection by Dimensions (Metric)

Bore Diameter 12 mm

Bore Diameter	OD	Width	Part Number	Type	Bearing Type
12	28	8	6001DDU	B2	Single Row Radial Ball Bearings
	28	8	6001DU	B2	Single Row Radial Ball Bearings
	28	8	6001VV	B6	Single Row Radial Ball Bearings
	28	8	6001Z	B1	Single Row Radial Ball Bearings
	28	8	6001ZZ	B1	Single Row Radial Ball Bearings
	28	8	7001ASTRDULP3	D	Super Precision Bearings
	28	8	7001ASTRDUMP3	D	Super Precision Bearings
	28	8	7001CTRDULP3	D	Super Precision Bearings
	28	8	7001CTRDUMP3	D	Super Precision Bearings
	30	13	53201	E1	Thrust Ball Bearings
	30	8	16101	B	Single Row Radial Ball Bearings
	32	10	1201J	G	Double Row Self Aligning Ball Bearings
	32	10	1201TN	G	Double Row Self Aligning Ball Bearings
	32	10	6201	B	Single Row Radial Ball Bearings
	32	10	6201DDU	B2	Single Row Radial Ball Bearings
	32	10	6201DDUNR	B5	Single Row Radial Ball Bearings
	32	10	6201DU	B2	Single Row Radial Ball Bearings
	32	10	6201N	B3	Single Row Radial Ball Bearings
	32	10	6201NR	B3	Single Row Radial Ball Bearings
	32	10	6201VV	B6	Single Row Radial Ball Bearings
	32	10	6201Z	B1	Single Row Radial Ball Bearings
	32	10	6201ZNR	B4	Single Row Radial Ball Bearings
	32	10	6201ZZ	B1	Single Row Radial Ball Bearings
	32	10	6201ZZNR	B4	Single Row Radial Ball Bearings
	32	10	7201BEAT85	D	Single Row Angular Contact Ball Bearings
	32	10	7201BEAT85SUN	D	Single Row Angular Contact Ball Bearings
	32	10	7201BW	D	Single Row Angular Contact Ball Bearings
	32	10	7201BWG	D	Single Row Angular Contact Ball Bearings
	32	14	2201J	G	Double Row Self Aligning Ball Bearings
	32	14	2201-2RSTN	G2	Double Row Self Aligning Ball Bearings
	32	14	2201ETN	G	Double Row Self Aligning Ball Bearings
	32	14	2201M	G	Double Row Self Aligning Ball Bearings
	32	14	4201J	L	Double Row Ball Bearings
	32	14	4201BTN	L	Double Row Ball Bearings
	32	14	62201DDU	B2	Single Row Radial Ball Bearings
	32	15,9	3201J	M	Double Row Angular Contact Ball Bearings
	32	15,9	3201B-2RSTN	M2	Double Row Angular Contact Ball Bearings
	32	15,9	3201B-2ZTN	M1	Double Row Angular Contact Ball Bearings
	32	15,9	3201BTN	M	Double Row Angular Contact Ball Bearings
	32	20	7201ASTRDULP3	D	Super Precision Bearings
	32	20	7201ASTRDUMP3	D	Super Precision Bearings
	32	20	7201CTRDULP3	D	Super Precision Bearings
	32	20	7201CTRDUMP3	D	Super Precision Bearings
32	7	E12	D1	Single Row Radial Ball Bearings	
32	7	EN12	D1	Single Row Radial Ball Bearings	
	35	15,9	LB3201B-2ZRSTN	M6	Double Row Angular Contact Ball Bearings
	35	15,9	LZ3201B-2ZRSTN	M7	Double Row Angular Contact Ball Bearings
	37	12	1301J	G	Double Row Self Aligning Ball Bearings
	37	12	6301	B	Single Row Radial Ball Bearings
	37	12	6301DDU	B2	Single Row Radial Ball Bearings
	37	12	6301DU	B2	Single Row Radial Ball Bearings
	37	12	6301VV	B6	Single Row Radial Ball Bearings
	37	12	6301Z	B1	Single Row Radial Ball Bearings
	37	12	6301ZZ	B1	Single Row Radial Ball Bearings
	37	12	7301BEAT85	D	Single Row Angular Contact Ball Bearings
	37	12	7301BEAT85SUN	D	Single Row Angular Contact Ball Bearings
	37	12	7301BW	D	Single Row Angular Contact Ball Bearings
	37	17	2301J	G	Double Row Self Aligning Ball Bearings
	37	17	2301M	G	Double Row Self Aligning Ball Bearings

Selection by Dimensions (Metric)

Bore Diameter 13 – 15 mm

Bore Diameter	OD	Width	Part Number	Type	Bearing Type
13	30	7	E13	D1	Single Row Radial Ball Bearings
	30	7	EN13	D1	Single Row Radial Ball Bearings
14	35	8	E14	D1	Single Row Radial Ball Bearings
15	15	24	5	6802B	Single Row Radial Ball Bearings
	24	5	6802DD	B2	Single Row Radial Ball Bearings
	24	5	6802VV	B6	Single Row Radial Ball Bearings
	24	5	6802ZZ	B1	Single Row Radial Ball Bearings
	28	7	6902	B	Single Row Radial Ball Bearings
	28	7	6902DD	B2	Single Row Radial Ball Bearings
	28	7	6902VV	B6	Single Row Radial Ball Bearings
	28	7	6902ZZ	B1	Single Row Radial Ball Bearings
	28	9	51102	E	Thrust Ball Bearings
	32	12	51202	E	Thrust Ball Bearings
	32	18	7002ASTRDULP3	D	Super Precision Bearings
	32	18	7002ASTRDUMP3	D	Super Precision Bearings
	32	18	7002CTRDULP3	D	Super Precision Bearings
	32	18	7002CTRDUMP3	D	Super Precision Bearings
	32	8	16002	B	Single Row Radial Ball Bearings
	32	9	6002	B	Single Row Radial Ball Bearings
	32	9	6002DDU	B2	Single Row Radial Ball Bearings
	32	9	6002DDUNR	B5	Single Row Radial Ball Bearings
	32	9	6002DU	B2	Single Row Radial Ball Bearings
	32	9	6002NR	B3	Single Row Radial Ball Bearings
	32	9	6002VV	B6	Single Row Radial Ball Bearings
	32	9	6002Z	B1	Single Row Radial Ball Bearings
	32	9	6002ZZ	B1	Single Row Radial Ball Bearings
	32	9	6002ZZNR	B4	Single Row Radial Ball Bearings
	32	9	7002BM	D	Single Row Angular Contact Ball Bearings
	35	11	1202J	G	Double Row Self Aligning Ball Bearings
	35	11	1202TN	G	Double Row Self Aligning Ball Bearings
	35	11	6202	B	Single Row Radial Ball Bearings
	35	11	6202DDU	B2	Single Row Radial Ball Bearings
	35	11	6202DDUNR	B5	Single Row Radial Ball Bearings
	35	11	6202DU	B2	Single Row Radial Ball Bearings
	35	11	6202NR	B3	Single Row Radial Ball Bearings
	35	11	6202VV	B6	Single Row Radial Ball Bearings
	35	11	6202Z	B1	Single Row Radial Ball Bearings
	35	11	6202ZNR	B4	Single Row Radial Ball Bearings
	35	11	6202ZZ	B1	Single Row Radial Ball Bearings
	35	11	6202ZZNR	B4	Single Row Radial Ball Bearings
	35	11	7202BEAT85	D	Single Row Angular Contact Ball Bearings
	35	11	7202BEAT85SUN	D	Single Row Angular Contact Ball Bearings
	35	11	7202BW	D	Single Row Angular Contact Ball Bearings
	35	11	7202BWG	D	Single Row Angular Contact Ball Bearings
	35	11	NJ202W	H1	Cylindrical Roller Bearings
	35	11	NU202W	H2	Cylindrical Roller Bearings
	35	11,75	30202	F	Tapered Roller Bearings
	35	14	2202J	G	Double Row Self Aligning Ball Bearings
	35	14	2202-2RSTN	G2	Double Row Self Aligning Ball Bearings
	35	14	2202ETN	G	Double Row Self Aligning Ball Bearings
	35	14	2202M	G	Double Row Self Aligning Ball Bearings
	35	14	4202J	L	Double Row Ball Bearings
	35	14	4202BTN	L	Double Row Ball Bearings
	35	15	53202	E1	Thrust Ball Bearings
	35	15,9	3202J	M	Double Row Angular Contact Ball Bearings
	35	15,9	3202B-2RSTN	M2	Double Row Angular Contact Ball Bearings
	35	15,9	3202B-2ZTN	M1	Double Row Angular Contact Ball Bearings
	35	15,9	3202BTN	M	Double Row Angular Contact Ball Bearings
	35	15,9	3202BZTN	M1	Double Row Angular Contact Ball Bearings

Selection by Dimensions (Metric)

Bore Diameter 15 – 17 mm

Bore Diameter	OD	Width	Part Number	Type	Bearing Type
15	35	22	7202ASTRDULP3	D	Super Precision Bearings
	35	22	7202ASTRDUMP3	D	Super Precision Bearings
	35	22	7202CTRDULP3	D	Super Precision Bearings
	35	22	7202CTRDUMP3	D	Super Precision Bearings
	35	8	E15	D1	Single Row Radial Ball Bearings
	40	10	B015	D1	Single Row Radial Ball Bearings
	40	15,9	LB3202B-2ZRSTN	M6	Double Row Angular Contact Ball Bearings
	40	15,9	LZ3202B-2ZRSTN	M7	Double Row Angular Contact Ball Bearings
	40	26	52204	N	Thrust Ball Bearings
	42	13	1302J	G	Double Row Self Aligning Ball Bearings
	42	13	1302TN	G	Double Row Self Aligning Ball Bearings
	42	13	6302	B	Single Row Radial Ball Bearings
	42	13	6302DDU	B2	Single Row Radial Ball Bearings
	42	13	6302DDUNR	B5	Single Row Radial Ball Bearings
	42	13	6302DU	B2	Single Row Radial Ball Bearings
	42	13	6302VV	B6	Single Row Radial Ball Bearings
	42	13	6302Z	B1	Single Row Radial Ball Bearings
	42	13	6302ZZ	B1	Single Row Radial Ball Bearings
	42	13	6302ZZNR	B4	Single Row Radial Ball Bearings
	42	13	7302BEAT85	D	Single Row Angular Contact Ball Bearings
	42	13	7302BW	D	Single Row Angular Contact Ball Bearings
	42	13	7302BWG	D	Single Row Angular Contact Ball Bearings
	42	14,25	30302J	F	Tapered Roller Bearings
	42	17	2302J	G	Double Row Self Aligning Ball Bearings
	42	17	2302-2RSTN	G2	Double Row Self Aligning Ball Bearings
	42	17	2302ETN	G	Double Row Self Aligning Ball Bearings
	42	17	4302BTN	L	Double Row Ball Bearings
	42	19	3302	M	Double Row Angular Contact Ball Bearings
	42	19	3302B-2RSTN	M2	Double Row Angular Contact Ball Bearings
	42	19	3302B-2ZTN	M1	Double Row Angular Contact Ball Bearings
	42	19	3302BTN	M	Double Row Angular Contact Ball Bearings
42	32	54204	N1	Thrust Ball Bearings	
	62	55	54405	N1	Thrust Ball Bearings
16	38	10	E16	D1	Single Row Radial Ball Bearings
17	26	5	6803	B	Single Row Radial Ball Bearings
	26	5	6803DD	B2	Single Row Radial Ball Bearings
	26	5	6803VV	B6	Single Row Radial Ball Bearings
	26	5	6803ZZ	B1	Single Row Radial Ball Bearings
	30	14	7903ASTRDULP3	D	Super Precision Bearings
	30	14	7903ASTRDUMP3	D	Super Precision Bearings
	30	14	7903CTRDULP3	D	Super Precision Bearings
	30	14	7903CTRDUMP3	D	Super Precision Bearings
	30	7	6903	B	Single Row Radial Ball Bearings
	30	7	6903DDU	B2	Single Row Radial Ball Bearings
	30	7	6903VV	B6	Single Row Radial Ball Bearings
	30	7	6903ZZ	B1	Single Row Radial Ball Bearings
	30	9	51103	E	Thrust Ball Bearings
		35	10	6003	B
35		10	6003DDU	B2	Single Row Radial Ball Bearings
35		10	6003DDUNR	B5	Single Row Radial Ball Bearings
35		10	6003DU	B2	Single Row Radial Ball Bearings
35		10	6003NR	B3	Single Row Radial Ball Bearings
35		10	6003VV	B6	Single Row Radial Ball Bearings
35		10	6003Z	B1	Single Row Radial Ball Bearings
35		10	6003ZNR	B4	Single Row Radial Ball Bearings
35		10	6003ZZ	B1	Single Row Radial Ball Bearings
35		10	6003ZZNR	B4	Single Row Radial Ball Bearings
35		10	7003AM	D	Single Row Angular Contact Ball Bearings
35		12	51203	E	Thrust Ball Bearings

Selection by Dimensions (Metric)

Bore Diameter 17 mm

Bore Diameter	OD	Width	Part Number	Type	Bearing Type
17	35	20	7003ASTRDULP3	D	Super Precision Bearings
	35	20	7003ASTRDUMP3	D	Super Precision Bearings
	35	20	7003CTRDULP3	D	Super Precision Bearings
	35	20	7003CTRDUMP3	D	Super Precision Bearings
	35	8	16003	B	Single Row Radial Ball Bearings
	38	15	53203	E1	Thrust Ball Bearings
	40	10	L17	D1	Single Row Radial Ball Bearings
	40	12	1203J	G	Double Row Self Aligning Ball Bearings
	40	12	1203TN	G	Double Row Self Aligning Ball Bearings
	40	12	6203	B	Single Row Radial Ball Bearings
	40	12	6203DDU	B2	Single Row Radial Ball Bearings
	40	12	6203DDUNR	B5	Single Row Radial Ball Bearings
	40	12	6203DU	B2	Single Row Radial Ball Bearings
	40	12	6203NR	B3	Single Row Radial Ball Bearings
	40	12	6203VV	B6	Single Row Radial Ball Bearings
	40	12	6203Z	B1	Single Row Radial Ball Bearings
	40	12	6203ZNR	B4	Single Row Radial Ball Bearings
	40	12	6203ZZ	B1	Single Row Radial Ball Bearings
	40	12	6203ZZNR	B4	Single Row Radial Ball Bearings
	40	12	7203BEAT85	D	Single Row Angular Contact Ball Bearings
	40	12	7203BEAT85SUN	D	Single Row Angular Contact Ball Bearings
	40	12	7203BW	D	Single Row Angular Contact Ball Bearings
	40	12	7203BWG	D	Single Row Angular Contact Ball Bearings
	40	12	N203W	H	Cylindrical Roller Bearings
	40	12	NF203W	H4	Cylindrical Roller Bearings
	40	12	NJ203W	H1	Cylindrical Roller Bearings
	40	12	NU203W	H2	Cylindrical Roller Bearings
	40	13,25	30203J	F	Tapered Roller Bearings
	40	16	2203J	G	Double Row Self Aligning Ball Bearings
	40	16	2203-2RSTN	G2	Double Row Self Aligning Ball Bearings
	40	16	2203ETN	G	Double Row Self Aligning Ball Bearings
	40	16	2203M	G	Double Row Self Aligning Ball Bearings
	40	16	4203J	L	Double Row Ball Bearings
	40	16	4203BTN	L	Double Row Ball Bearings
	40	17,25	32203J	F	Tapered Roller Bearings
	40	17,46	LDJK17TNH	P1	Double Row Angular Contact Ball Bearings
	40	17,5	3203J	M	Double Row Angular Contact Ball Bearings
	40	17,5	3203B-2RSTN	M2	Double Row Angular Contact Ball Bearings
	40	17,5	3203B-2ZTN	M1	Double Row Angular Contact Ball Bearings
	40	17,5	3203BTN	M	Double Row Angular Contact Ball Bearings
	40	24	7203ASTRDULP3	D	Super Precision Bearings
	40	24	7203ASTRDUMP3	D	Super Precision Bearings
	40	24	7203CTRDULP3	D	Super Precision Bearings
	40	24	7203CTRDUMP3	D	Super Precision Bearings
	44	11	B017	D1	Single Row Radial Ball Bearings
	44	11	E17	D1	Single Row Radial Ball Bearings
	47	14	1303J	G	Double Row Self Aligning Ball Bearings
	47	14	1303TN	G	Double Row Self Aligning Ball Bearings
	47	14	6303	B	Single Row Radial Ball Bearings
	47	14	6303DDU	B2	Single Row Radial Ball Bearings
	47	14	6303DU	B2	Single Row Radial Ball Bearings
	47	14	6303NR	B3	Single Row Radial Ball Bearings
	47	14	6303VV	B6	Single Row Radial Ball Bearings
	47	14	6303Z	B1	Single Row Radial Ball Bearings
	47	14	6303ZNR	B4	Single Row Radial Ball Bearings
	47	14	6303ZZ	B1	Single Row Radial Ball Bearings
	47	14	6303ZZNR	B4	Single Row Radial Ball Bearings
	47	14	7303BEAT85	D	Single Row Angular Contact Ball Bearings
	47	14	7303BEAT85SUN	D	Single Row Angular Contact Ball Bearings
	47	14	7303BW	D	Single Row Angular Contact Ball Bearings

Selection by Dimensions (Metric)

Bore Diameter 17 – 20 mm

Bore Diameter	OD	Width	Part Number	Type	Bearing Type
17	47	14	7303BWG	D	Single Row Angular Contact Ball Bearings
	47	15	17TAC47BSUC10PN7B	D	Super Precision Bearings
	47	15,25	30303J	F	Tapered Roller Bearings
	47	17,5	LB3203B-2ZRSTN	M6	Double Row Angular Contact Ball Bearings
	47	17,5	LZ3203B-2ZRSTN	M7	Double Row Angular Contact Ball Bearings
	47	19	2303J	G	Double Row Self Aligning Ball Bearings
	47	19	2303-2RSTN	G2	Double Row Self Aligning Ball Bearings
	47	19	2303TN	G	Double Row Self Aligning Ball Bearings
	47	19	4303J	L	Double Row Ball Bearings
	47	19	4303BTN	L	Double Row Ball Bearings
	47	20,25	32303	F	Tapered Roller Bearings
	47	22,2	3303J	M	Double Row Angular Contact Ball Bearings
	47	22,2	3303B-2RSTN	M2	Double Row Angular Contact Ball Bearings
	47	22,2	3303B-2ZTN	M1	Double Row Angular Contact Ball Bearings
	47	22,2	3303BTN	M	Double Row Angular Contact Ball Bearings
	47	22,23	MDJK17M	P1	Double Row Angular Contact Ball Bearings
	47	28	7303CTDULP4	D	Super Precision Bearings
	47	28	7303ETDULP4	D	Super Precision Bearings
	47	28	7303ETDUMP4	D	Super Precision Bearings
	47	30	BSB017047DUHP3	D	Super Precision Bearings
	62	17	6403	B	Single Row Radial Ball Bearings
	62	17	6403ZZ	B1	Single Row Radial Ball Bearings
18	40	9	E18	D1	Single Row Radial Ball Bearings
19	40	9	E19	D1	Single Row Radial Ball Bearings
20	32	7	6804	B	Single Row Radial Ball Bearings
	32	7	6804DD	B2	Single Row Radial Ball Bearings
	32	7	6804VV	B6	Single Row Radial Ball Bearings
	32	7	6804ZZ	B1	Single Row Radial Ball Bearings
	35	10	51104	E	Thrust Ball Bearings
	37	18	7904ASTRDULP3	D	Super Precision Bearings
	37	18	7904ASTRDUMP3	D	Super Precision Bearings
	37	18	7904CTRDULP3	D	Super Precision Bearings
	37	18	7904CTRDUMP3	D	Super Precision Bearings
	37	9	6904	B	Single Row Radial Ball Bearings
	37	9	6904DDU	B2	Single Row Radial Ball Bearings
	37	9	6904VV	B6	Single Row Radial Ball Bearings
	37	9	6904Z	B1	Single Row Radial Ball Bearings
	37	9	6904ZZ	B1	Single Row Radial Ball Bearings
		40	14	51204	E
	42	12	6004	B	Single Row Radial Ball Bearings
	42	12	6004DDU	B2	Single Row Radial Ball Bearings
	42	12	6004DDUNR	B5	Single Row Radial Ball Bearings
	42	12	6004DU	B2	Single Row Radial Ball Bearings
	42	12	6004NR	B3	Single Row Radial Ball Bearings
	42	12	6004TCG12P4	B	Super Precision Bearings
	42	12	6004TCG12P4	B	Super Precision Bearings
	42	12	6004VV	B6	Single Row Radial Ball Bearings
	42	12	6004Z	B1	Single Row Radial Ball Bearings
	42	12	6004ZZ	B1	Single Row Radial Ball Bearings
	42	12	6004ZZNR	B4	Single Row Radial Ball Bearings
	42	12	7004AM	D	Single Row Angular Contact Ball Bearings
	42	15	32004XJ	F	Tapered Roller Bearings
	42	17	53204	E1	Thrust Ball Bearings
	42	24	7004ASTRDULP3	D	Super Precision Bearings
	42	24	7004ASTRDUMP3	D	Super Precision Bearings
	42	24	7004CTRDULP3	D	Super Precision Bearings
	42	24	7004CTRDUMP3	D	Super Precision Bearings
	42	24	T7004CTDULP3	D	Super Precision Bearings
	42	8	16004	B	Single Row Radial Ball Bearings

Selection by Dimensions (Metric)

Bore Diameter 20 mm

Bore Diameter	OD	Width	Part Number	Type	Bearing Type	
20	47	12	E20	D1	Single Row Radial Ball Bearings	
	47	14	1204J	G	Double Row Self Aligning Ball Bearings	
	47	14	1204KTN	G1	Double Row Self Aligning Ball Bearings	
	47	14	1204TN	G	Double Row Self Aligning Ball Bearings	
	47	14	6204	B	Single Row Radial Ball Bearings	
	47	14	6204DDU	B2	Single Row Radial Ball Bearings	
	47	14	6204DDUNR	B5	Single Row Radial Ball Bearings	
	47	14	6204DU	B2	Single Row Radial Ball Bearings	
	47	14	6204NR	B3	Single Row Radial Ball Bearings	
	47	14	6204TCG12P4	B	Super Precision Bearings	
	47	14	6204TCG12P4	B	Super Precision Bearings	
	47	14	6204VV	B6	Single Row Radial Ball Bearings	
	47	14	6204Z	B1	Single Row Radial Ball Bearings	
	47	14	6204ZNR	B4	Single Row Radial Ball Bearings	
	47	14	6204ZZ	B1	Single Row Radial Ball Bearings	
	47	14	6204ZZNR	B4	Single Row Radial Ball Bearings	
	47	14	7204BEAT85	D	Single Row Angular Contact Ball Bearings	
	47	14	7204BEAT85SUN	D	Single Row Angular Contact Ball Bearings	
	47	14	7204BW	D	Single Row Angular Contact Ball Bearings	
	47	14	7204BWG	D	Single Row Angular Contact Ball Bearings	
	47	14	L20	D1	Single Row Radial Ball Bearings	
	47	14	N204ET	H	Cylindrical Roller Bearings	
	47	14	N204W	H	Cylindrical Roller Bearings	
	47	14	NF204W	H4	Cylindrical Roller Bearings	
	47	14	NJ204ET	H1	Cylindrical Roller Bearings	
	47	14	NJ204W	H1	Cylindrical Roller Bearings	
	47	14	NU204ET	H2	Cylindrical Roller Bearings	
	47	14	NU204W	H2	Cylindrical Roller Bearings	
	47	14	NUP204W	H3	Cylindrical Roller Bearings	
	47	15	20TAC47BSUC10PN7B	D	Super Precision Bearings	
	47	15,25	30204J	F	Tapered Roller Bearings	
	47	18	2204J	G	Double Row Self Aligning Ball Bearings	
	47	18	2204-2RSTN	G2	Double Row Self Aligning Ball Bearings	
	47	18	2204EKTN	G1	Double Row Self Aligning Ball Bearings	
	47	18	2204ETN	G	Double Row Self Aligning Ball Bearings	
	47	18	2204KJ	G1	Double Row Self Aligning Ball Bearings	
	47	18	2204M	G	Double Row Self Aligning Ball Bearings	
	47	18	4204J	L	Double Row Ball Bearings	
	47	18	4204BTN	L	Double Row Ball Bearings	
	47	18	51304	E	Thrust Ball Bearings	
	47	18	NJ2204W	H1	Cylindrical Roller Bearings	
	47	18	NU2204W	H3	Cylindrical Roller Bearings	
	47	19,25	32204J	F	Tapered Roller Bearings	
	47	20,6	3204B-2RSTN	M2	Double Row Angular Contact Ball Bearings	
	47	20,6	3204B-2ZTN	M1	Double Row Angular Contact Ball Bearings	
	47	20,6	3204BTN	M	Double Row Angular Contact Ball Bearings	
	47	20,6	3204J	M	Double Row Angular Contact Ball Bearings	
	47	20,64	LDJK20M	P1	Double Row Angular Contact Ball Bearings	
	47	28	52205	N	Thrust Ball Bearings	
	47	28	7204ASTRDULP3	D	Super Precision Bearings	
	47	28	7204ASTRDUMP3	D	Super Precision Bearings	
	47	28	7204CTRDULP3	D	Super Precision Bearings	
	47	28	7204CTRDUMP3	D	Super Precision Bearings	
	47	30	BSB020047DUHP3	D	Super Precision Bearings	
	47	31,75	BSB078DUHP3	D	Super Precision Bearings	
	47	40	11204TN	G4	Double Row Self Aligning Ball Bearings	
		50	36	54205	N1	Thrust Ball Bearings
		52	15	1304J	G	Double Row Self Aligning Ball Bearings
		52	15	1304KJ	G1	Double Row Self Aligning Ball Bearings
		52	15	1304TN	G	Double Row Self Aligning Ball Bearings
		52	15	21304CDE4	K	Spherical Roller Bearings

Selection by Dimensions (Metric)

Bore Diameter 20 – 25 mm

Bore Diameter	OD	Width	Part Number	Type	Bearing Type
20	52	15	6304	B	Single Row Radial Ball Bearings
	52	15	6304DDU	B2	Single Row Radial Ball Bearings
	52	15	6304DDUNR	B5	Single Row Radial Ball Bearings
	52	15	6304DU	B2	Single Row Radial Ball Bearings
	52	15	6304NR	B3	Single Row Radial Ball Bearings
	52	15	6304TBR12P4	B	Super Precision Bearings
	52	15	6304VV	B6	Single Row Radial Ball Bearings
	52	15	6304Z	B1	Single Row Radial Ball Bearings
	52	15	6304ZNR	B4	Single Row Radial Ball Bearings
	52	15	6304ZZ	B1	Single Row Radial Ball Bearings
	52	15	6304ZZNR	B4	Single Row Radial Ball Bearings
	52	15	7304BEAT85	D	Single Row Angular Contact Ball Bearings
	52	15	7304BEAT85SUN	D	Single Row Angular Contact Ball Bearings
	52	15	7304BW	D	Single Row Angular Contact Ball Bearings
	52	15	7304BWG	D	Single Row Angular Contact Ball Bearings
	52	15	N304W	H	Cylindrical Roller Bearings
	52	15	NF304ET	H4	Cylindrical Roller Bearings
	52	15	NF304W	H4	Cylindrical Roller Bearings
	52	15	NJ304ET	H1	Cylindrical Roller Bearings
	52	15	NJ304W	H1	Cylindrical Roller Bearings
	52	15	NU304ET	H2	Cylindrical Roller Bearings
	52	15	NU304W	H2	Cylindrical Roller Bearings
	52	16,25	30304J	F	Tapered Roller Bearings
	52	20,6	LB3204B-2ZRSTN	M6	Double Row Angular Contact Ball Bearings
	52	20,6	LZ3204B-2ZRSTN	M7	Double Row Angular Contact Ball Bearings
	52	21	2304J	G	Double Row Self Aligning Ball Bearings
	52	21	2304-2RSTN	G2	Double Row Self Aligning Ball Bearings
	52	21	2304KJ	G1	Double Row Self Aligning Ball Bearings
	52	21	2304M	G	Double Row Self Aligning Ball Bearings
	52	21	4304J	L	Double Row Ball Bearings
	52	21	4304BTN	L	Double Row Ball Bearings
	52	22,2	3304J	M	Double Row Angular Contact Ball Bearings
	52	22,2	3304B-2RSTN	M2	Double Row Angular Contact Ball Bearings
	52	22,2	3304B-2ZTN	M1	Double Row Angular Contact Ball Bearings
	52	22,2	3304BTN	M	Double Row Angular Contact Ball Bearings
	52	22,23	MDJT20M	P	Double Row Angular Contact Ball Bearings
	52	22,25	32304J	F	Tapered Roller Bearings
	52	30	7304CTDULP4	D	Super Precision Bearings
	52	30	7304CTDUMP4	D	Super Precision Bearings
	52	30	7304ETDULP4	D	Super Precision Bearings
	52	30	7304ETDUMP4	D	Super Precision Bearings
	52	34	52305	N	Thrust Ball Bearings
	55	42	54305	N1	Thrust Ball Bearings
	72	19	6404	B	Single Row Radial Ball Bearings
22	75	62	54406	N1	Thrust Ball Bearings
	44	12	60/22	B	Single Row Radial Ball Bearings
	44	12	60/22DDU	B2	Single Row Radial Ball Bearings
	44	12	60/22Z	B1	Single Row Radial Ball Bearings
	44	12	60/22ZZ	B1	Single Row Radial Ball Bearings
	44	15	320/22XJ	F	Tapered Roller Bearings
	50	14	62/22	B	Single Row Radial Ball Bearings
	50	14	62/22DDU	B2	Single Row Radial Ball Bearings
	50	14	62/22ZZ	B1	Single Row Radial Ball Bearings
25	56	16	63/22	B	Single Row Radial Ball Bearings
	56	16	63/22DDU	B2	Single Row Radial Ball Bearings
	56	16	63/22N	B	Single Row Radial Ball Bearings
	56	16	63/22NR	B3	Single Row Radial Ball Bearings
	37	7	6805	B	Single Row Radial Ball Bearings
	37	7	6805DD	B2	Single Row Radial Ball Bearings

Selection by Dimensions (Metric)

Bore Diameter 25 mm

Bore Diameter	OD	Width	Part Number	Type	Bearing Type
25	37	7	6805VV	B6	Single Row Radial Ball Bearings
	37	7	6805ZZ	B1	Single Row Radial Ball Bearings
42	42	11	51105	E	Thrust Ball Bearings
	42	18	7905ASTRDULP3	D	Super Precision Bearings
	42	18	7905ASTRDUMP3	D	Super Precision Bearings
	42	18	7905CTRDULP3	D	Super Precision Bearings
	42	18	7905CTRDUMP3	D	Super Precision Bearings
	42	9	6905	B	Single Row Radial Ball Bearings
	42	9	6905DDU	B2	Single Row Radial Ball Bearings
	42	9	6905VV	B6	Single Row Radial Ball Bearings
	42	9	6905ZZ	B1	Single Row Radial Ball Bearings
47	47	12	6005	B	Single Row Radial Ball Bearings
	47	12	6005DDU	B2	Single Row Radial Ball Bearings
	47	12	6005DDUNR	B5	Single Row Radial Ball Bearings
	47	12	6005DU	B2	Single Row Radial Ball Bearings
	47	12	6005NR	B3	Single Row Radial Ball Bearings
	47	12	6005TCG12P4	B	Super Precision Bearings
	47	12	6005TCG12P4	B	Super Precision Bearings
	47	12	6005VV	B6	Single Row Radial Ball Bearings
	47	12	6005Z	B1	Single Row Radial Ball Bearings
	47	12	6005ZNR	B4	Single Row Radial Ball Bearings
	47	12	6005ZZ	B1	Single Row Radial Ball Bearings
	47	12	6005ZZNR	B4	Single Row Radial Ball Bearings
	47	12	7005AM	D	Single Row Angular Contact Ball Bearings
	47	12	NU1005M	H2	Cylindrical Roller Bearings
	47	15	51205	E	Thrust Ball Bearings
	47	15	32005XJ	F	Tapered Roller Bearings
	47	17	33005J	F	Tapered Roller Bearings
	47	24	7005ASTRDULP3	D	Super Precision Bearings
	47	24	7005ASTRDUMP3	D	Super Precision Bearings
	47	24	7005CTRDULP3	D	Super Precision Bearings
	47	24	7005CTRDUMP3	D	Super Precision Bearings
47	24	T7005CTDULP3	D	Super Precision Bearings	
47	8	16005	B	Single Row Radial Ball Bearings	
50	19	53205	E1	Thrust Ball Bearings	
52	52	15	1205J	G	Double Row Self Aligning Ball Bearings
	52	15	1205KJ	G1	Double Row Self Aligning Ball Bearings
	52	15	1205KTN	G1	Double Row Self Aligning Ball Bearings
	52	15	1205TN	G	Double Row Self Aligning Ball Bearings
	52	15	6205	B	Single Row Radial Ball Bearings
	52	15	6205DDU	B2	Single Row Radial Ball Bearings
	52	15	6205DDUNR	B5	Single Row Radial Ball Bearings
	52	15	6205DU	B2	Single Row Radial Ball Bearings
	52	15	6205NR	B3	Single Row Radial Ball Bearings
	52	15	6205TCG12P4	B	Super Precision Bearings
	52	15	6205TCG12P4	B	Super Precision Bearings
	52	15	6205VV	B6	Single Row Radial Ball Bearings
	52	15	6205Z	B1	Single Row Radial Ball Bearings
	52	15	6205ZNR	B4	Single Row Radial Ball Bearings
	52	15	6205ZZ	B1	Single Row Radial Ball Bearings
	52	15	6205ZZNR	B4	Single Row Radial Ball Bearings
	52	15	7205BEAT85	D	Single Row Angular Contact Ball Bearings
	52	15	7205BEAT85SUN	D	Single Row Angular Contact Ball Bearings
	52	15	7205BW	D	Single Row Angular Contact Ball Bearings
	52	15	7205BWG	D	Single Row Angular Contact Ball Bearings
	52	15	BL205	C	Single Row Radial Ball Bearings
52	15	N205ET	H	Cylindrical Roller Bearings	
52	15	N205W	H	Cylindrical Roller Bearings	
52	15	NF205W	H4	Cylindrical Roller Bearings	
52	15	NJ205ET	H1	Cylindrical Roller Bearings	

Selection by Dimensions (Metric)

Bore Diameter 25 mm

Bore Diameter	OD	Width	Part Number	Type	Bearing Type	
25	52	15	NJ205EW	H1	Cylindrical Roller Bearings	
	52	15	NU205EM	H2	Cylindrical Roller Bearings	
	52	15	NU205ET	H2	Cylindrical Roller Bearings	
	52	15	NU205EW	H2	Cylindrical Roller Bearings	
	52	15	NUP205ET	H3	Cylindrical Roller Bearings	
	52	15	NUP205EW	H3	Cylindrical Roller Bearings	
	52	16,25	30205J	F	Tapered Roller Bearings	
	52	18	2205J	G	Double Row Self Aligning Ball Bearings	
	52	18	2205-2RSTN	G2	Double Row Self Aligning Ball Bearings	
	52	18	2205EKTN	G1	Double Row Self Aligning Ball Bearings	
	52	18	2205ETN	G	Double Row Self Aligning Ball Bearings	
	52	18	2205KJ	G1	Double Row Self Aligning Ball Bearings	
	52	18	2205K-2RSTN	G3	Double Row Self Aligning Ball Bearings	
	52	18	22205CE4	K	Spherical Roller Bearings	
	52	18	22205CKE4	K1	Spherical Roller Bearings	
	52	18	22205EJW33	K	Spherical Roller Bearings	
	52	18	22205EKJW33	K1	Spherical Roller Bearings	
	52	18	4205J	L	Double Row Ball Bearings	
	52	18	4205BTN	L	Double Row Ball Bearings	
	52	18	51305	E	Thrust Ball Bearings	
	52	18	62205DDU	B2	Single Row Radial Ball Bearings	
	52	18	N2205W	H	Cylindrical Roller Bearings	
	52	18	NJ2205ET	H1	Cylindrical Roller Bearings	
	52	18	NJ2205W	H1	Cylindrical Roller Bearings	
	52	18	NU2205ET	H2	Cylindrical Roller Bearings	
	52	18	NU2205M	H2	Cylindrical Roller Bearings	
	52	18	NU2205W	H2	Cylindrical Roller Bearings	
	52	18	NUP2205ET	H3	Cylindrical Roller Bearings	
	52	18	NUP2205M	H3	Cylindrical Roller Bearings	
	52	18	NUP2205W	H3	Cylindrical Roller Bearings	
	52	19,25	32205J	F	Tapered Roller Bearings	
	52	20,6	3205B-2RSNRTN	M5	Double Row Angular Contact Ball Bearings	
	52	20,6	3205B-2RSTN	M2	Double Row Angular Contact Ball Bearings	
	52	20,6	3205B-2ZTN	M1	Double Row Angular Contact Ball Bearings	
	52	20,6	3205BNRTN	M3	Double Row Angular Contact Ball Bearings	
	52	20,6	3205BTN	M	Double Row Angular Contact Ball Bearings	
	52	20,6	3205J	M	Double Row Angular Contact Ball Bearings	
	52	20,64	LDJK25M	P1	Double Row Angular Contact Ball Bearings	
	52	20,64	LDJT25M	P	Double Row Angular Contact Ball Bearings	
	52	25	33205J	F	Tapered Roller Bearings	
	52	29	52206	N	Thrust Ball Bearings	
	52	30	7205ASTRDULP3	D	Super Precision Bearings	
	52	30	7205ASTRDUMP3	D	Super Precision Bearings	
	52	30	7205CTRDULP3	D	Super Precision Bearings	
	52	30	7205CTRDUMP3	D	Super Precision Bearings	
	52	44	11205TN	G4	Double Row Self Aligning Ball Bearings	
		55	37	54206	N1	Thrust Ball Bearings
		60	24	51405	E	Thrust Ball Bearings
		60	38	52306	N	Thrust Ball Bearings
		62	15	25TAC62BSUC10PN7B	D	Super Precision Bearings
		62	17	1305J	G	Double Row Self Aligning Ball Bearings
		62	17	1305KJ	G1	Double Row Self Aligning Ball Bearings
	62	17	1305KTN	G1	Double Row Self Aligning Ball Bearings	
	62	17	1305TN	G	Double Row Self Aligning Ball Bearings	
	62	17	21305CDE4	K	Spherical Roller Bearings	
	62	17	21305CDKE4	K1	Spherical Roller Bearings	
	62	17	21305J	K	Spherical Roller Bearings	
	62	17	6305	B	Single Row Radial Ball Bearings	
	62	17	6305DDU	B2	Single Row Radial Ball Bearings	
	62	17	6305DDUNR	B5	Single Row Radial Ball Bearings	
	62	17	6305DU	B2	Single Row Radial Ball Bearings	

Selection by Dimensions (Metric)

Bore Diameter 25 mm

Bore Diameter	OD	Width	Part Number	Type	Bearing Type
25	62	17	6305N	B3	Single Row Radial Ball Bearings
	62	17	6305NR	B3	Single Row Radial Ball Bearings
	62	17	6305TBR12P4	B	Super Precision Bearings
	62	17	6305VV	B6	Single Row Radial Ball Bearings
	62	17	6305Z	B1	Single Row Radial Ball Bearings
	62	17	6305ZNR	B4	Single Row Radial Ball Bearings
	62	17	6305ZZ	B1	Single Row Radial Ball Bearings
	62	17	6305ZZNR	B4	Single Row Radial Ball Bearings
	62	17	7305BEAT85	D	Single Row Angular Contact Ball Bearings
	62	17	7305BEAT85SUN	D	Single Row Angular Contact Ball Bearings
	62	17	7305BW	D	Single Row Angular Contact Ball Bearings
	62	17	7305BWG	D	Single Row Angular Contact Ball Bearings
	62	17	BL305	C	Single Row Radial Ball Bearings
	62	17	BL305ZNR	C3	Single Row Radial Ball Bearings
	62	17	BL305ZZ	C2	Single Row Radial Ball Bearings
	62	17	N305ET	H	Cylindrical Roller Bearings
	62	17	N305W	H	Cylindrical Roller Bearings
	62	17	NF305ET	H4	Cylindrical Roller Bearings
	62	17	NF305W	H4	Cylindrical Roller Bearings
	62	17	NJ305ET	H1	Cylindrical Roller Bearings
	62	17	NJ305EW	H1	Cylindrical Roller Bearings
	62	17	NU305ET	H2	Cylindrical Roller Bearings
	62	17	NU305EW	H2	Cylindrical Roller Bearings
	62	17	NUP305ET	H3	Cylindrical Roller Bearings
	62	17	NUP305EW	H3	Cylindrical Roller Bearings
	62	18,25	30305J	F	Tapered Roller Bearings
	62	18,25	31305J	F	Tapered Roller Bearings
	62	20,6	LB3205B-2ZRSTN	M6	Double Row Angular Contact Ball Bearings
	62	20,6	LZ3205B-2ZRSTN	M7	Double Row Angular Contact Ball Bearings
	62	24	2305J	G	Double Row Self Aligning Ball Bearings
	62	24	2305-2RSTN	G2	Double Row Self Aligning Ball Bearings
	62	24	2305KJ	G1	Double Row Self Aligning Ball Bearings
	62	24	2305KTN	G1	Double Row Self Aligning Ball Bearings
	62	24	2305M	G	Double Row Self Aligning Ball Bearings
	62	24	2305TN	G	Double Row Self Aligning Ball Bearings
	62	24	4305J	L	Double Row Ball Bearings
	62	24	4305BTN	L	Double Row Ball Bearings
	62	24	NJ2305ET	H1	Cylindrical Roller Bearings
	62	24	NJ2305W	H1	Cylindrical Roller Bearings
	62	24	NU2305ET	H2	Cylindrical Roller Bearings
	62	24	NU2305W	H2	Cylindrical Roller Bearings
	62	24	NUP2305ET	H3	Cylindrical Roller Bearings
	62	24	NUP2305W	H3	Cylindrical Roller Bearings
	62	25,25	32305J	F	Tapered Roller Bearings
	62	25,4	3305B-2RSNRTN	M5	Double Row Angular Contact Ball Bearings
	62	25,4	3305B-2RSTN	M2	Double Row Angular Contact Ball Bearings
	62	25,4	3305B-2ZNRTN	M4	Double Row Angular Contact Ball Bearings
	62	25,4	3305B-2ZTN	M1	Double Row Angular Contact Ball Bearings
	62	25,4	3305BNRTN	M3	Double Row Angular Contact Ball Bearings
	62	25,4	3305BTN	M	Double Row Angular Contact Ball Bearings
	62	25,4	3305J	M	Double Row Angular Contact Ball Bearings
	62	25,4	MDJK25M	P1	Double Row Angular Contact Ball Bearings
	62	29	53405	E1	Thrust Ball Bearings
	62	30	BSB025062DUHP3	D	Super Precision Bearings
	62	34	7305CTDULP4	D	Super Precision Bearings
	62	34	7305CTDUMP4	D	Super Precision Bearings
	62	34	7305ETDULP4	D	Super Precision Bearings
	62	34	7305ETDUMP4	D	Super Precision Bearings
	62	46	54306	N1	Thrust Ball Bearings
	80	21	6405	B	Single Row Radial Ball Bearings
	80	21	6405ZZ	B1	Single Row Radial Ball Bearings
	80	21	7405BMG	D	Single Row Angular Contact Ball Bearings

Selection by Dimensions (Metric)

Bore Diameter 25 – 30 mm

Bore Diameter	OD	Width	Part Number	Type	Bearing Type
25	80	21	N405W	H	Cylindrical Roller Bearings
	80	21	NF405W	H4	Cylindrical Roller Bearings
	80	21	NJ405W	H1	Cylindrical Roller Bearings
	80	21	NU405W	H2	Cylindrical Roller Bearings
	85	69	54407	N1	Thrust Ball Bearings
28	52	12	60/28	B	Single Row Radial Ball Bearings
	52	12	60/28DD	B2	Single Row Radial Ball Bearings
	52	16	320/28XJ	F	Tapered Roller Bearings
	58	16	62/28	B	Single Row Radial Ball Bearings
	58	16	62/28DDU	B2	Single Row Radial Ball Bearings
	58	16	62/28NR	B3	Single Row Radial Ball Bearings
	58	16	62/28ZNR	B4	Single Row Radial Ball Bearings
	58	16	62/28ZZ	B1	Single Row Radial Ball Bearings
	58	20,25	322/28	F	Tapered Roller Bearings
	68	18	63/28	B	Single Row Radial Ball Bearings
	68	18	63/28N	B3	Single Row Radial Ball Bearings
	68	18	63/28NR	B3	Single Row Radial Ball Bearings
	68	18	63/28ZZ	B1	Single Row Radial Ball Bearings
30	42	7	6806	B	Single Row Radial Ball Bearings
	42	7	6806DD	B2	Single Row Radial Ball Bearings
	42	7	6806VV	B6	Single Row Radial Ball Bearings
	42	7	6806ZZ	B1	Single Row Radial Ball Bearings
	47	11	51106	E	Thrust Ball Bearings
	47	18	7906ASTRDULP3	D	Super Precision Bearings
	47	18	7906ASTRDUMP3	D	Super Precision Bearings
	47	18	7906CTRDULP3	D	Super Precision Bearings
	47	18	7906CTRDUMP3	D	Super Precision Bearings
	47	9	6906	B	Single Row Radial Ball Bearings
	47	9	6906DDU	B2	Single Row Radial Ball Bearings
	47	9	6906VV	B6	Single Row Radial Ball Bearings
	47	9	6906ZZ	B1	Single Row Radial Ball Bearings
	47	9	7906ASTRV1VSULP3	D	Super Precision Bearings
	47	9	7906ASTRV1VSUMP3	D	Super Precision Bearings
	47	9	7906CTRV1VSULP3	D	Super Precision Bearings
	47	9	7906CTRV1VSUMP3	D	Super Precision Bearings
		53	16	51206	E
	55	13	6006	B	Single Row Radial Ball Bearings
	55	13	6006DDU	B2	Single Row Radial Ball Bearings
	55	13	6006DDUNR	B5	Single Row Radial Ball Bearings
	55	13	6006DU	B2	Single Row Radial Ball Bearings
	55	13	6006NR	B3	Single Row Radial Ball Bearings
	55	13	6006TCG12P4	B	Super Precision Bearings
	55	13	6006TCG12P4	B	Super Precision Bearings
	55	13	6006VV	B6	Single Row Radial Ball Bearings
	55	13	6006Z	B1	Single Row Radial Ball Bearings
	55	13	6006ZNR	B4	Single Row Radial Ball Bearings
	55	13	6006ZZ	B1	Single Row Radial Ball Bearings
	55	13	6006ZZNR	B4	Single Row Radial Ball Bearings
	55	13	7006AM	D	Single Row Angular Contact Ball Bearings
	55	13	7006ASTRV1VSULP3	D	Super Precision Bearings
	55	13	7006ASTRV1VSUMP3	D	Super Precision Bearings
	55	13	7006BM	D	Single Row Angular Contact Ball Bearings
	55	13	7006CTRV1VSULP3	D	Super Precision Bearings
	55	13	7006CTRV1VSUMP3	D	Super Precision Bearings
	55	13	NU1006M	H2	Cylindrical Roller Bearings
	55	17	32006XJ	F	Tapered Roller Bearings
	55	19	NN3006MBKRE3CC1P4	I	Super Precision Bearings
	55	20	53206	E1	Thrust Ball Bearings
	55	26	7006ASTRDULP3	D	Super Precision Bearings

Selection by Dimensions (Metric)

Bore Diameter 30 mm

Bore Diameter	OD	Width	Part Number	Type	Bearing Type
30	55	26	7006ASTRDUMP3	D	Super Precision Bearings
	55	26	7006CTRDULP3	D	Super Precision Bearings
	55	26	7006CTRDUMP3	D	Super Precision Bearings
	55	26	T7006CTDULP3	D	Super Precision Bearings
	55	9	16006	B	Single Row Radial Ball Bearings
	60	21	51306	E	Thrust Ball Bearings
	62	15	30TAC62BSUC10PN7B	D	Super Precision Bearings
	62	16	1206J	G	Double Row Self Aligning Ball Bearings
	62	16	1206KJ	G1	Double Row Self Aligning Ball Bearings
	62	16	1206KTN	G1	Double Row Self Aligning Ball Bearings
	62	16	1206TN	G	Double Row Self Aligning Ball Bearings
	62	16	6206	B	Single Row Radial Ball Bearings
	62	16	6206DDU	B2	Single Row Radial Ball Bearings
	62	16	6206DDUNR	B5	Single Row Radial Ball Bearings
	62	16	6206DU	B2	Single Row Radial Ball Bearings
	62	16	6206NR	B3	Single Row Radial Ball Bearings
	62	16	6206TCG12P4	B	Super Precision Bearings
	62	16	6206TCG12P4	B	Super Precision Bearings
	62	16	6206VV	B6	Single Row Radial Ball Bearings
	62	16	6206Z	B1	Single Row Radial Ball Bearings
	62	16	6206ZNR	B4	Single Row Radial Ball Bearings
	62	16	6206ZZ	B1	Single Row Radial Ball Bearings
	62	16	6206ZZNR	B4	Single Row Radial Ball Bearings
	62	16	7206BEAT85	D	Single Row Angular Contact Ball Bearings
	62	16	7206BEAT85SUN	D	Single Row Angular Contact Ball Bearings
	62	16	7206BW	D	Single Row Angular Contact Ball Bearings
	62	16	7206BWG	D	Single Row Angular Contact Ball Bearings
	62	16	BL206	C	Single Row Radial Ball Bearings
	62	16	BL206ZNR	C3	Single Row Radial Ball Bearings
	62	16	BL206ZZ	C2	Single Row Radial Ball Bearings
	62	16	N206ET	H	Cylindrical Roller Bearings
	62	16	N206W	H	Cylindrical Roller Bearings
	62	16	NF206W	H4	Cylindrical Roller Bearings
	62	16	NJ206ET	H1	Cylindrical Roller Bearings
	62	16	NJ206EW	H1	Cylindrical Roller Bearings
	62	16	NU206ET	H2	Cylindrical Roller Bearings
	62	16	NU206EW	H2	Cylindrical Roller Bearings
	62	16	NUP206ET	H3	Cylindrical Roller Bearings
	62	16	NUP206EW	H3	Cylindrical Roller Bearings
	62	17,25	30206J	F	Tapered Roller Bearings
	62	20	2206J	G	Double Row Self Aligning Ball Bearings
	62	20	2206-2RSTN	G2	Double Row Self Aligning Ball Bearings
	62	20	2206EKTN	G1	Double Row Self Aligning Ball Bearings
	62	20	2206ETN	G	Double Row Self Aligning Ball Bearings
	62	20	2206KJ	G1	Double Row Self Aligning Ball Bearings
	62	20	2206K-2RSTN	G3	Double Row Self Aligning Ball Bearings
	62	20	22206CE4	K	Spherical Roller Bearings
	62	20	22206CKE4	K1	Spherical Roller Bearings
	62	20	22206EJW33	K	Spherical Roller Bearings
	62	20	22206EKJW33	K1	Spherical Roller Bearings
	62	20	4206J	L	Double Row Ball Bearings
	62	20	4206BTN	L	Double Row Ball Bearings
	62	20	NJ2206ET	H1	Cylindrical Roller Bearings
	62	20	NJ2206W	H1	Cylindrical Roller Bearings
	62	20	NU2206ET	H2	Cylindrical Roller Bearings
	62	20	NU2206M	H2	Cylindrical Roller Bearings
	62	20	NU2206W	H2	Cylindrical Roller Bearings
	62	20	NUP2206ET	H3	Cylindrical Roller Bearings
	62	20	NUP2206M	H3	Cylindrical Roller Bearings
	62	20	NUP2206W	H3	Cylindrical Roller Bearings
	62	21,25	32206J	F	Tapered Roller Bearings

Selection by Dimensions (Metric)

Bore Diameter 30 mm

Bore Diameter	OD	Width	Part Number	Type	Bearing Type
30	62	23,8	3206B-2RSNRTN	M5	Double Row Angular Contact Ball Bearings
	62	23,8	3206B-2RSTN	M2	Double Row Angular Contact Ball Bearings
	62	23,8	3206B-2ZNRTN	M4	Double Row Angular Contact Ball Bearings
	62	23,8	3206B-2ZTN	M1	Double Row Angular Contact Ball Bearings
	62	23,8	3206BNRTN	M3	Double Row Angular Contact Ball Bearings
	62	23,8	3206BTN	M	Double Row Angular Contact Ball Bearings
	62	23,8	3206J	M	Double Row Angular Contact Ball Bearings
	62	23,81	LDJK30M	P1	Double Row Angular Contact Ball Bearings
	62	23,81	LDJT30M	P	Double Row Angular Contact Ball Bearings
	62	25	53306	E1	Thrust Ball Bearings
	62	25	33206J	F	Tapered Roller Bearings
	62	30	BSB030062DUHP3	D	Super Precision Bearings
	62	32	7206ASTRDULP3	D	Super Precision Bearings
	62	32	7206ASTRDUMP3	D	Super Precision Bearings
	62	32	7206CTRDULP3	D	Super Precision Bearings
	62	32	7206CTRDUMP3	D	Super Precision Bearings
	62	32	BSB2030DUHP3	D	Super Precision Bearings
	62	34	52207	N	Thrust Ball Bearings
	62	48	11206TN	G4	Double Row Self Aligning Ball Bearings
		65	42	54207	N1
	68	36	52208	N	Thrust Ball Bearings
	68	44	52307	N	Thrust Ball Bearings
	70	28	51406	E	Thrust Ball Bearings
	72	15	30TAC72BSUC10PN7B	D	Super Precision Bearings
	72	19	1306J	G	Double Row Self Aligning Ball Bearings
	72	19	1306KJ	G1	Double Row Self Aligning Ball Bearings
	72	19	1306KTN	G1	Double Row Self Aligning Ball Bearings
	72	19	1306TN	G	Double Row Self Aligning Ball Bearings
	72	19	21306CDE4	K	Spherical Roller Bearings
	72	19	21306CDKE4	K1	Spherical Roller Bearings
	72	19	21306J	K	Spherical Roller Bearings
	72	19	6306	B	Single Row Radial Ball Bearings
	72	19	6306DDU	B2	Single Row Radial Ball Bearings
	72	19	6306DDUNR	B5	Single Row Radial Ball Bearings
	72	19	6306DU	B2	Single Row Radial Ball Bearings
	72	19	6306N	B3	Single Row Radial Ball Bearings
	72	19	6306NR	B3	Single Row Radial Ball Bearings
	72	19	6306TBR12P4	B	Super Precision Bearings
	72	19	6306VV	B6	Single Row Radial Ball Bearings
	72	19	6306Z	B1	Single Row Radial Ball Bearings
	72	19	6306ZN	B4	Single Row Radial Ball Bearings
	72	19	6306ZNR	B4	Single Row Radial Ball Bearings
	72	19	6306ZZ	B1	Single Row Radial Ball Bearings
	72	19	6306ZZNR	B4	Single Row Radial Ball Bearings
	72	19	7306BEAT85	D	Single Row Angular Contact Ball Bearings
	72	19	7306BEAT85SUN	D	Single Row Angular Contact Ball Bearings
	72	19	7306BW	D	Single Row Angular Contact Ball Bearings
	72	19	7306BWG	D	Single Row Angular Contact Ball Bearings
	72	19	N306ET	H	Cylindrical Roller Bearings
	72	19	N306W	H	Cylindrical Roller Bearings
	72	19	NF306ET	H4	Cylindrical Roller Bearings
	72	19	NF306W	H4	Cylindrical Roller Bearings
	72	19	NJ306ET	H1	Cylindrical Roller Bearings
	72	19	NJ306EW	H1	Cylindrical Roller Bearings
	72	19	NU306ET	H2	Cylindrical Roller Bearings
	72	19	NU306EW	H2	Cylindrical Roller Bearings
	72	19	NUP306ET	H3	Cylindrical Roller Bearings
	72	19	NUP306EW	H3	Cylindrical Roller Bearings
	72	20,75	30306J	F	Tapered Roller Bearings
	72	20,75	31306J	F	Tapered Roller Bearings

Selection by Dimensions (Metric)

Bore Diameter 30 – 35 mm

Bore Diameter	OD	Width	Part Number	Type	Bearing Type	
30	72	23,8	LB3206B-2ZRSTN	M6	Double Row Angular Contact Ball Bearings	
	72	23,8	LZ3206B-2ZRSTN	M7	Double Row Angular Contact Ball Bearings	
	72	27	2306J	G	Double Row Self Aligning Ball Bearings	
	72	27	2306-2RSTN	G2	Double Row Self Aligning Ball Bearings	
	72	27	2306KJ	G1	Double Row Self Aligning Ball Bearings	
	72	27	2306KTN	G1	Double Row Self Aligning Ball Bearings	
	72	27	2306M	G	Double Row Self Aligning Ball Bearings	
	72	27	2306TN	G	Double Row Self Aligning Ball Bearings	
	72	27	4306J	L	Double Row Ball Bearings	
	72	27	4306BTN	L	Double Row Ball Bearings	
	72	27	NJ2306ET	H1	Cylindrical Roller Bearings	
	72	27	NJ2306M	H1	Cylindrical Roller Bearings	
	72	27	NJ2306W	H1	Cylindrical Roller Bearings	
	72	27	NU2306ET	H2	Cylindrical Roller Bearings	
	72	27	NU2306W	H2	Cylindrical Roller Bearings	
	72	27	NUP2306ET	H3	Cylindrical Roller Bearings	
	72	27	NUP2306W	H3	Cylindrical Roller Bearings	
	72	28,75	32306J	F	Tapered Roller Bearings	
	72	30	BSB030072DUHP3	D	Super Precision Bearings	
	72	30,16	MDJK30M	P1	Double Row Angular Contact Ball Bearings	
	72	30,2	3306B-2RSTN	M2	Double Row Angular Contact Ball Bearings	
	72	30,2	3306B-2ZTN	M1	Double Row Angular Contact Ball Bearings	
	72	30,2	3306BNRTN	M3	Double Row Angular Contact Ball Bearings	
	72	30,2	3306BTN	M	Double Row Angular Contact Ball Bearings	
	72	30,2	3306J	M	Double Row Angular Contact Ball Bearings	
	72	38	7306CTDULP4	D	Super Precision Bearings	
	72	38	7306CTDUMP4	D	Super Precision Bearings	
	72	38	7306ETDULP4	D	Super Precision Bearings	
	72	38	7306ETDUMP4	D	Super Precision Bearings	
	72	44	54208	N1	Thrust Ball Bearings	
	72	52	54307	N1	Thrust Ball Bearings	
		75	33	53406	E1	Thrust Ball Bearings
		78	49	52308	N	Thrust Ball Bearings
	82	59	54308	N1	Thrust Ball Bearings	
90	90	23	6406	B	Single Row Radial Ball Bearings	
	90	23	6406ZZ	B1	Single Row Radial Ball Bearings	
	90	23	7406BMG	D	Single Row Angular Contact Ball Bearings	
	90	23	N406W	H	Cylindrical Roller Bearings	
	90	23	NJ406M	H1	Cylindrical Roller Bearings	
	90	23	NJ406W	H1	Cylindrical Roller Bearings	
	90	23	NU406W	H2	Cylindrical Roller Bearings	
		95	77	54408	N1	Thrust Ball Bearings
32	58	13	60/32	B	Single Row Radial Ball Bearings	
	58	13	60/32DDU	B2	Single Row Radial Ball Bearings	
	58	13	60/32ZZ	B1	Single Row Radial Ball Bearings	
	58	17	320/32XJ	F	Tapered Roller Bearings	
65	65	17	62/32	B	Single Row Radial Ball Bearings	
	65	17	62/32DDU	B2	Single Row Radial Ball Bearings	
	65	22,25	322/32	F	Tapered Roller Bearings	
75	75	20	63/32	B	Single Row Radial Ball Bearings	
	75	20	63/32DDU	B2	Single Row Radial Ball Bearings	
	75	20	63/32DDUNR	B5	Single Row Radial Ball Bearings	
	75	20	63/32N	B3	Single Row Radial Ball Bearings	
	75	20	63/32NR	B3	Single Row Radial Ball Bearings	
	75	20	63/32ZNR	B4	Single Row Radial Ball Bearings	
	75	20	63/32ZZ	B1	Single Row Radial Ball Bearings	
35	100	25	6407	B	Single Row Radial Ball Bearings	
	100	25	6407AZZ	B1	Single Row Radial Ball Bearings	

Selection by Dimensions (Metric)

Bore Diameter 35 mm

Bore Diameter	OD	Width	Part Number	Type	Bearing Type
35	100	25	7407BMG	D	Single Row Angular Contact Ball Bearings
	100	25	N407W	H	Cylindrical Roller Bearings
	100	25	NF407W	H4	Cylindrical Roller Bearings
	100	25	NJ407M	H1	Cylindrical Roller Bearings
	100	25	NJ407W	H1	Cylindrical Roller Bearings
	100	25	NU407W	H2	Cylindrical Roller Bearings
	105	86	54409	N1	Thrust Ball Bearings
	47	7	6807	B	Single Row Radial Ball Bearings
	47	7	6807VV	B6	Single Row Radial Ball Bearings
	47	7	6807ZZ	B1	Single Row Radial Ball Bearings
	53	12	51107	E	Thrust Ball Bearings
	55	10	6907	B	Single Row Radial Ball Bearings
	55	10	6907DDU	B2	Single Row Radial Ball Bearings
	55	10	6907VV	B6	Single Row Radial Ball Bearings
	55	10	6907ZZ	B1	Single Row Radial Ball Bearings
	55	10	7907ASTRV1VSULP3	D	Super Precision Bearings
	55	10	7907ASTRV1VSUMP3	D	Super Precision Bearings
	55	10	7907CTRV1VSULP3	D	Super Precision Bearings
	55	10	7907CTRV1VSUMP3	D	Super Precision Bearings
	55	14	32907J	F	Tapered Roller Bearings
	55	20	7907ASTRDULP3	D	Super Precision Bearings
	55	20	7907ASTRDUMP3	D	Super Precision Bearings
	55	20	7907CTRDULP3	D	Super Precision Bearings
	55	20	7907CTRDUMP3	D	Super Precision Bearings
		62	14	6007	B
62		14	6007DDU	B2	Single Row Radial Ball Bearings
62		14	6007DDUNR	B5	Single Row Radial Ball Bearings
62		14	6007DU	B2	Single Row Radial Ball Bearings
62		14	6007NR	B3	Single Row Radial Ball Bearings
62		14	6007TCG12P4	B	Super Precision Bearings
62		14	6007TCG12P4	B	Super Precision Bearings
62		14	6007VV	B6	Single Row Radial Ball Bearings
62		14	6007Z	B1	Single Row Radial Ball Bearings
62		14	6007ZNR	B4	Single Row Radial Ball Bearings
62		14	6007ZZ	B1	Single Row Radial Ball Bearings
62		14	6007ZZNR	B4	Single Row Radial Ball Bearings
62		14	7007AM	D	Single Row Angular Contact Ball Bearings
62		14	7007ASTRV1VSULP3	D	Super Precision Bearings
62		14	7007ASTRV1VSUMP3	D	Super Precision Bearings
62		14	7007BM	D	Single Row Angular Contact Ball Bearings
62		14	7007CTRV1VSULP3	D	Super Precision Bearings
62		14	7007CTRV1VSUMP3	D	Super Precision Bearings
62		14	NU1007M	H2	Cylindrical Roller Bearings
62		18	51207	E	Thrust Ball Bearings
62		18	32007XJ	F	Tapered Roller Bearings
62		20	NN3007MBKRE4CC1P4	I	Super Precision Bearings
62		21	33007J	F	Tapered Roller Bearings
62		28	7007ASTRDULP3	D	Super Precision Bearings
62		28	7007ASTRDUMP3	D	Super Precision Bearings
62		28	7007CTRDULP3	D	Super Precision Bearings
62		28	7007CTRDUMP3	D	Super Precision Bearings
62		28	T7007CTDULP3	D	Super Precision Bearings
62	9	16007	B	Single Row Radial Ball Bearings	
	65	22	53207	E1	Thrust Ball Bearings
	68	24	51307	E	Thrust Ball Bearings
	72	15	35TAC72BSUC10PN7B	D	Super Precision Bearings
	72	17	1207J	G	Double Row Self Aligning Ball Bearings
	72	17	1207KJ	G1	Double Row Self Aligning Ball Bearings
	72	17	1207KTN	G1	Double Row Self Aligning Ball Bearings

Selection by Dimensions (Metric)

Bore Diameter 35 mm

Bore Diameter	OD	Width	Part Number	Type	Bearing Type
35	72	17	1207TN	G	Double Row Self Aligning Ball Bearings
	72	17	6207	B	Single Row Radial Ball Bearings
	72	17	6207DDU	B2	Single Row Radial Ball Bearings
	72	17	6207DDUNR	B5	Single Row Radial Ball Bearings
	72	17	6207DU	B2	Single Row Radial Ball Bearings
	72	17	6207NR	B3	Single Row Radial Ball Bearings
	72	17	6207TCG12P4	B	Super Precision Bearings
	72	17	6207TCG12P4	B	Super Precision Bearings
	72	17	6207VV	B6	Single Row Radial Ball Bearings
	72	17	6207Z	B1	Single Row Radial Ball Bearings
	72	17	6207ZN	B4	Single Row Radial Ball Bearings
	72	17	6207ZNR	B4	Single Row Radial Ball Bearings
	72	17	6207ZZ	B1	Single Row Radial Ball Bearings
	72	17	6207ZZNR	B4	Single Row Radial Ball Bearings
	72	17	7207BEAT85	D	Single Row Angular Contact Ball Bearings
	72	17	7207BEAT85SUN	D	Single Row Angular Contact Ball Bearings
	72	17	7207BW	D	Single Row Angular Contact Ball Bearings
	72	17	7207BWG	D	Single Row Angular Contact Ball Bearings
	72	17	BL207	C	Single Row Radial Ball Bearings
	72	17	BL207ZZ	C2	Single Row Radial Ball Bearings
	72	17	N207ET	H	Cylindrical Roller Bearings
	72	17	N207W	H	Cylindrical Roller Bearings
	72	17	NF207W	H4	Cylindrical Roller Bearings
	72	17	NJ207ET	H1	Cylindrical Roller Bearings
	72	17	NJ207EW	H1	Cylindrical Roller Bearings
	72	17	NU207EM	H2	Cylindrical Roller Bearings
	72	17	NU207ET	H2	Cylindrical Roller Bearings
	72	17	NU207EW	H2	Cylindrical Roller Bearings
	72	17	NUP207ET	H3	Cylindrical Roller Bearings
	72	17	NUP207EW	H3	Cylindrical Roller Bearings
	72	18,25	30207J	F	Tapered Roller Bearings
	72	23	2207J	G	Double Row Self Aligning Ball Bearings
	72	23	2207-2RSTN	G2	Double Row Self Aligning Ball Bearings
	72	23	2207EKTN	G1	Double Row Self Aligning Ball Bearings
	72	23	2207ETN	G	Double Row Self Aligning Ball Bearings
	72	23	2207KJ	G1	Double Row Self Aligning Ball Bearings
	72	23	2207K-2RSTN	G3	Double Row Self Aligning Ball Bearings
	72	23	22207CE4	K	Spherical Roller Bearings
	72	23	22207CKE4	K1	Spherical Roller Bearings
	72	23	22207EJW33	K	Spherical Roller Bearings
	72	23	22207EKJW33	K1	Spherical Roller Bearings
	72	23	4207J	L	Double Row Ball Bearings
	72	23	4207BTN	L	Double Row Ball Bearings
	72	23	NJ2207ET	H1	Cylindrical Roller Bearings
	72	23	NJ2207W	H1	Cylindrical Roller Bearings
	72	23	NU2207ET	H2	Cylindrical Roller Bearings
	72	23	NU2207M	H2	Cylindrical Roller Bearings
	72	23	NU2207W	H2	Cylindrical Roller Bearings
	72	23	NUP2207ET	H3	Cylindrical Roller Bearings
	72	23	NUP2207M	H3	Cylindrical Roller Bearings
	72	23	NUP2207W	H3	Cylindrical Roller Bearings
	72	24,25	32207J	F	Tapered Roller Bearings
	72	26,99	LDJT35M	P	Double Row Angular Contact Ball Bearings
	72	27	3207B-2RSTN	M2	Double Row Angular Contact Ball Bearings
	72	27	3207B-2ZTN	M1	Double Row Angular Contact Ball Bearings
	72	27	3207BNRTN	M3	Double Row Angular Contact Ball Bearings
	72	27	3207BTN	M	Double Row Angular Contact Ball Bearings
	72	27	3207J	M	Double Row Angular Contact Ball Bearings
	72	28	53307	E1	Thrust Ball Bearings
	72	28	33207J	F	Tapered Roller Bearings
	72	30	BSB035072DUHP3	D	Super Precision Bearings
	72	34	7207ASTROULP3	D	Super Precision Bearings

Selection by Dimensions (Metric)

Bore Diameter 35 mm

Bore Diameter	OD	Width	Part Number	Type	Bearing Type
35	72	34	7207ASTRDUMP3	D	Super Precision Bearings
	72	34	7207CTRDULP3	D	Super Precision Bearings
	72	34	7207CTRDUMP3	D	Super Precision Bearings
	72	52	11207TN	G4	Double Row Self Aligning Ball Bearings
	73	37	52209	N	Thrust Ball Bearings
	78	45	54209	N1	Thrust Ball Bearings
	80	21	1307J	G	Double Row Self Aligning Ball Bearings
	80	21	1307KJ	G1	Double Row Self Aligning Ball Bearings
	80	21	1307KTN	G1	Double Row Self Aligning Ball Bearings
	80	21	1307TN	G	Double Row Self Aligning Ball Bearings
	80	21	21307CDE4	K	Spherical Roller Bearings
	80	21	21307CDKE4	K1	Spherical Roller Bearings
	80	21	21307J	K	Spherical Roller Bearings
	80	21	6307	B	Single Row Radial Ball Bearings
	80	21	6307DDU	B2	Single Row Radial Ball Bearings
	80	21	6307DDUNR	B5	Single Row Radial Ball Bearings
	80	21	6307DU	B2	Single Row Radial Ball Bearings
	80	21	6307M	B	Single Row Radial Ball Bearings
	80	21	6307N	B3	Single Row Radial Ball Bearings
	80	21	6307NR	B3	Single Row Radial Ball Bearings
	80	21	6307TBR12P4	B	Super Precision Bearings
	80	21	6307VV	B6	Single Row Radial Ball Bearings
	80	21	6307Z	B1	Single Row Radial Ball Bearings
	80	21	6307ZNR	B4	Single Row Radial Ball Bearings
	80	21	6307ZZ	B1	Single Row Radial Ball Bearings
	80	21	6307ZZNR	B4	Single Row Radial Ball Bearings
	80	21	7307BEAT85	D	Single Row Angular Contact Ball Bearings
	80	21	7307BEAT85SUN	D	Single Row Angular Contact Ball Bearings
	80	21	7307BW	D	Single Row Angular Contact Ball Bearings
	80	21	7307BWG	D	Single Row Angular Contact Ball Bearings
	80	21	BL307	C	Single Row Radial Ball Bearings
	80	21	BL307NR	C1	Single Row Radial Ball Bearings
	80	21	BL307Z	C2	Single Row Radial Ball Bearings
	80	21	BL307ZNR	C3	Single Row Radial Ball Bearings
	80	21	BL307ZZ	C2	Single Row Radial Ball Bearings
	80	21	N307ET	H	Cylindrical Roller Bearings
	80	21	N307W	H	Cylindrical Roller Bearings
	80	21	NF307ET	H4	Cylindrical Roller Bearings
	80	21	NF307W	H4	Cylindrical Roller Bearings
	80	21	NJ307ET	H1	Cylindrical Roller Bearings
	80	21	NJ307EW	H1	Cylindrical Roller Bearings
	80	21	NU307EM	H2	Cylindrical Roller Bearings
	80	21	NU307ET	H2	Cylindrical Roller Bearings
	80	21	NU307EW	H2	Cylindrical Roller Bearings
	80	21	NUP307ET	H3	Cylindrical Roller Bearings
	80	21	NUP307EW	H3	Cylindrical Roller Bearings
	80	22,75	30307J	F	Tapered Roller Bearings
	80	22,75	31307J	F	Tapered Roller Bearings
	80	27	LB3207B-2ZRSTN	M6	Double Row Angular Contact Ball Bearings
	80	27	LZ3207B-2ZRSTN	M7	Double Row Angular Contact Ball Bearings
	80	31	2307J	G	Double Row Self Aligning Ball Bearings
	80	31	2307-2RSTN	G2	Double Row Self Aligning Ball Bearings
	80	31	2307KJ	G1	Double Row Self Aligning Ball Bearings
	80	31	2307KTN	G1	Double Row Self Aligning Ball Bearings
	80	31	2307TN	G	Double Row Self Aligning Ball Bearings
	80	31	4307J	L	Double Row Ball Bearings
	80	31	4307BTN	L	Double Row Ball Bearings
	80	31	NJ2307ET	H1	Cylindrical Roller Bearings
	80	31	NJ2307W	H1	Cylindrical Roller Bearings
	80	31	NU2307ET	H2	Cylindrical Roller Bearings
	80	31	NU2307W	H2	Cylindrical Roller Bearings

Selection by Dimensions (Metric)

Bore Diameter 35 – 40 mm

Bore Diameter	OD	Width	Part Number	Type	Bearing Type	
35	80	31	NUP2307ET	H3	Cylindrical Roller Bearings	
	80	31	NUP2307W	H3	Cylindrical Roller Bearings	
	80	32	51407	E	Thrust Ball Bearings	
	80	32,75	32307J	F	Tapered Roller Bearings	
	80	34,9	3307B-2RSTN	M2	Double Row Angular Contact Ball Bearings	
	80	34,9	3307B-2ZTN	M1	Double Row Angular Contact Ball Bearings	
	80	34,9	3307BNRTN	M3	Double Row Angular Contact Ball Bearings	
	80	34,9	3307BTN	M	Double Row Angular Contact Ball Bearings	
	80	34,9	3307J	M	Double Row Angular Contact Ball Bearings	
	80	34,93	MDJK35M	P1	Double Row Angular Contact Ball Bearings	
	80	42	7307CTDULP4	D	Super Precision Bearings	
	80	42	7307CTDUMP4	D	Super Precision Bearings	
	80	42	7307ETDULP4	D	Super Precision Bearings	
	80	42	7307ETDUMP4	D	Super Precision Bearings	
	85	37	53407	E1	Thrust Ball Bearings	
	85	52	52309	N	Thrust Ball Bearings	
	90	62	54309	N1	Thrust Ball Bearings	
40	100	40	BSB040100DUHP3	D	Super Precision Bearings	
	100	70	54310	N1	Thrust Ball Bearings	
	110	27	6408	B	Single Row Radial Ball Bearings	
	110	27	6408ZZ	B1	Single Row Radial Ball Bearings	
	110	27	7408BMG	D	Single Row Angular Contact Ball Bearings	
	110	27	7408BW	D	Single Row Angular Contact Ball Bearings	
	110	27	N408W	H	Cylindrical Roller Bearings	
	110	27	NJ408M	H1	Cylindrical Roller Bearings	
	110	27	NJ408W	H1	Cylindrical Roller Bearings	
	110	27	NU408M	H2	Cylindrical Roller Bearings	
	110	27	NU408W	H2	Cylindrical Roller Bearings	
	110	27	NUP408M	H3	Cylindrical Roller Bearings	
	110	49,21	HDJK40M	P1	Double Row Angular Contact Ball Bearings	
		115	92	54410	N1	Thrust Ball Bearings
		52	7	6808	B	Single Row Radial Ball Bearings
		52	7	6808DD	B2	Single Row Radial Ball Bearings
52		7	6808VV	B6	Single Row Radial Ball Bearings	
52		7	6808ZZ	B1	Single Row Radial Ball Bearings	
	60	13	51108	E	Thrust Ball Bearings	
	62	12	6908	B	Single Row Radial Ball Bearings	
	62	12	6908DDU	B2	Single Row Radial Ball Bearings	
	62	12	6908VV	B6	Single Row Radial Ball Bearings	
	62	12	6908ZZ	B1	Single Row Radial Ball Bearings	
	62	12	7908A5TRV1VSULP3	D	Super Precision Bearings	
	62	12	7908A5TRV1VSUMP3	D	Super Precision Bearings	
	62	12	7908CTRV1VSULP3	D	Super Precision Bearings	
	62	12	7908CTRV1VSUMP3	D	Super Precision Bearings	
	62	24	7908A5TRDULP3	D	Super Precision Bearings	
	62	24	7908A5TRDUMP3	D	Super Precision Bearings	
	62	24	7908CTRDULP3	D	Super Precision Bearings	
	62	24	7908CTRDUMP3	D	Super Precision Bearings	
		68	15	6008	B	Single Row Radial Ball Bearings
		68	15	6008DDU	B2	Single Row Radial Ball Bearings
68		15	6008DDUNR	B5	Single Row Radial Ball Bearings	
68		15	6008DU	B2	Single Row Radial Ball Bearings	
68		15	6008NR	B3	Single Row Radial Ball Bearings	
68		15	6008TCG12P4	B	Super Precision Bearings	
68		15	6008TCG12P4	B	Super Precision Bearings	
68		15	6008VV	B6	Single Row Radial Ball Bearings	
68		15	6008Z	B1	Single Row Radial Ball Bearings	
68		15	6008ZNR	B4	Single Row Radial Ball Bearings	

Selection by Dimensions (Metric)

Bore Diameter 40 mm

Bore Diameter	OD	Width	Part Number	Type	Bearing Type
40	68	15	6008ZZ	B1	Single Row Radial Ball Bearings
	68	15	6008ZZNR	B4	Single Row Radial Ball Bearings
	68	15	7008AM	D	Single Row Angular Contact Ball Bearings
	68	15	7008ASTRV1VSULP3	D	Super Precision Bearings
	68	15	7008ASTRV1VSUMP3	D	Super Precision Bearings
	68	15	7008BM	D	Single Row Angular Contact Ball Bearings
	68	15	7008CTRV1VSULP3	D	Super Precision Bearings
	68	15	7008CTRV1VSUMP3	D	Super Precision Bearings
	68	15	NU1008M	H2	Cylindrical Roller Bearings
	68	19	51208	E	Thrust Ball Bearings
	68	19	32008XJ	F	Tapered Roller Bearings
	68	21	NN3008MBKRCC1P4	I	Super Precision Bearings
	68	30	7008ASTRDULP3	D	Super Precision Bearings
	68	30	7008ASTRDUMP3	D	Super Precision Bearings
	68	30	7008CTRDULP3	D	Super Precision Bearings
	68	30	7008CTRDUMP3	D	Super Precision Bearings
	68	30	T7008CTDULP3	D	Super Precision Bearings
	68	37	RS-5008DSE7NAS5	H6	Cylindrical Roller Bearings
	68	9	16008	B	Single Row Radial Ball Bearings
		72	15	40TAC72BSUC10PN7B	D
72		23	53208	E1	Thrust Ball Bearings
72		30	BSB040072DUHP3	D	Super Precision Bearings
	78	26	51308	E	Thrust Ball Bearings
	78	39	52210	N	Thrust Ball Bearings
	80	18	1208J	G	Double Row Self Aligning Ball Bearings
	80	18	1208KJ	G1	Double Row Self Aligning Ball Bearings
	80	18	1208KTN	G1	Double Row Self Aligning Ball Bearings
	80	18	1208TN	G	Double Row Self Aligning Ball Bearings
	80	18	6208	B	Single Row Radial Ball Bearings
	80	18	6208DDU	B2	Single Row Radial Ball Bearings
	80	18	6208DDUNR	B5	Single Row Radial Ball Bearings
	80	18	6208DU	B2	Single Row Radial Ball Bearings
	80	18	6208M	B	Single Row Radial Ball Bearings
	80	18	6208N	B3	Single Row Radial Ball Bearings
	80	18	6208NR	B3	Single Row Radial Ball Bearings
	80	18	6208TCG12P4	B	Super Precision Bearings
	80	18	6208TCG12P4	B	Super Precision Bearings
	80	18	6208VV	B6	Single Row Radial Ball Bearings
	80	18	6208Z	B1	Single Row Radial Ball Bearings
	80	18	6208ZNR	B4	Single Row Radial Ball Bearings
	80	18	6208ZZ	B1	Single Row Radial Ball Bearings
	80	18	6208ZZNR	B4	Single Row Radial Ball Bearings
	80	18	7208BEAT85	D	Single Row Angular Contact Ball Bearings
	80	18	7208BEAT85SUN	D	Single Row Angular Contact Ball Bearings
	80	18	7208BW	D	Single Row Angular Contact Ball Bearings
	80	18	7208BWG	D	Single Row Angular Contact Ball Bearings
	80	18	BL208	C	Single Row Radial Ball Bearings
	80	18	BL208NR	C1	Single Row Radial Ball Bearings
	80	18	BL208Z	C2	Single Row Radial Ball Bearings
	80	18	BL208ZNR	C3	Single Row Radial Ball Bearings
	80	18	BL208ZZ	C2	Single Row Radial Ball Bearings
	80	18	N208ET	H	Cylindrical Roller Bearings
	80	18	N208M	H	Cylindrical Roller Bearings
	80	18	N208W	H	Cylindrical Roller Bearings
	80	18	NF208W	H4	Cylindrical Roller Bearings
	80	18	NJ208ET	H1	Cylindrical Roller Bearings
	80	18	NJ208EW	H1	Cylindrical Roller Bearings
80	18	NU208EM	H2	Cylindrical Roller Bearings	
80	18	NU208ET	H2	Cylindrical Roller Bearings	
80	18	NU208EW	H2	Cylindrical Roller Bearings	
80	18	NUP208ET	H3	Cylindrical Roller Bearings	

Selection by Dimensions (Metric)

Bore Diameter 40 mm

Bore Diameter	OD	Width	Part Number	Type	Bearing Type	
40	80	18	NUP208EW	H3	Cylindrical Roller Bearings	
	80	19,75	30208J	F	Tapered Roller Bearings	
	80	23	2208J	G	Double Row Self Aligning Ball Bearings	
	80	23	2208-2RSTN	G2	Double Row Self Aligning Ball Bearings	
	80	23	2208EKTN	G1	Double Row Self Aligning Ball Bearings	
	80	23	2208ETN	G	Double Row Self Aligning Ball Bearings	
	80	23	2208KJ	G1	Double Row Self Aligning Ball Bearings	
	80	23	2208K-2RSTN	G3	Double Row Self Aligning Ball Bearings	
	80	23	22208EAE4	K	Spherical Roller Bearings	
	80	23	22208EAKE4	K1	Spherical Roller Bearings	
	80	23	22208EJW33	K	Spherical Roller Bearings	
	80	23	22208EKJW33	K1	Spherical Roller Bearings	
	80	23	4208J	L	Double Row Ball Bearings	
	80	23	4208BTN	L	Double Row Ball Bearings	
	80	23	N2208W	H	Cylindrical Roller Bearings	
	80	23	NF2208W	H4	Cylindrical Roller Bearings	
	80	23	NJ2208ET	H1	Cylindrical Roller Bearings	
	80	23	NJ2208W	H1	Cylindrical Roller Bearings	
	80	23	NU2208ET	H2	Cylindrical Roller Bearings	
	80	23	NU2208M	H2	Cylindrical Roller Bearings	
	80	23	NU2208W	H2	Cylindrical Roller Bearings	
	80	23	NUP2208ET	H3	Cylindrical Roller Bearings	
	80	23	NUP2208W	H3	Cylindrical Roller Bearings	
	80	24,75	32208J	F	Tapered Roller Bearings	
	80	30,16	LDJT40M	P	Double Row Angular Contact Ball Bearings	
	80	30,2	3208B-2RSTN	M2	Double Row Angular Contact Ball Bearings	
	80	30,2	3208B-2ZNRN	M4	Double Row Angular Contact Ball Bearings	
	80	30,2	3208B-2ZTN	M1	Double Row Angular Contact Ball Bearings	
	80	30,2	3208BTN	M	Double Row Angular Contact Ball Bearings	
	80	30,2	3208J	M	Double Row Angular Contact Ball Bearings	
	80	32	33208J	F	Tapered Roller Bearings	
	80	36	7208A5TRDULP3	D	Super Precision Bearings	
	80	36	7208A5TRDUMP3	D	Super Precision Bearings	
	80	36	7208CTRDULP3	D	Super Precision Bearings	
	80	36	7208CTRDUMP3	D	Super Precision Bearings	
	80	56	11208TN	G4	Double Row Self Aligning Ball Bearings	
		82	31	53308	E1	Thrust Ball Bearings
		82	47	54210	N1	Thrust Ball Bearings
		90	15	40TAC90BSUC10PN7B	D	Super Precision Bearings
		90	23	1308J	G	Double Row Self Aligning Ball Bearings
		90	23	1308KJ	G1	Double Row Self Aligning Ball Bearings
		90	23	1308KTN	G1	Double Row Self Aligning Ball Bearings
		90	23	1308TN	G	Double Row Self Aligning Ball Bearings
	90	23	21308EAE4	K	Spherical Roller Bearings	
	90	23	21308EAKE4	K1	Spherical Roller Bearings	
	90	23	21308J	K	Spherical Roller Bearings	
	90	23	21308KJ	K1	Spherical Roller Bearings	
	90	23	6308	B	Single Row Radial Ball Bearings	
	90	23	6308DDU	B2	Single Row Radial Ball Bearings	
	90	23	6308DDUNR	B5	Single Row Radial Ball Bearings	
	90	23	6308DU	B2	Single Row Radial Ball Bearings	
	90	23	6308M	B	Single Row Radial Ball Bearings	
	90	23	6308N	B3	Single Row Radial Ball Bearings	
	90	23	6308NR	B3	Single Row Radial Ball Bearings	
	90	23	6308TBR12P4	B	Super Precision Bearings	
	90	23	6308VV	B6	Single Row Radial Ball Bearings	
	90	23	6308Z	B1	Single Row Radial Ball Bearings	
	90	23	6308ZNR	B4	Single Row Radial Ball Bearings	
	90	23	6308ZZ	B1	Single Row Radial Ball Bearings	
	90	23	6308ZZNR	B4	Single Row Radial Ball Bearings	
	90	23	7308BEAT85	D	Single Row Angular Contact Ball Bearings	

Selection by Dimensions (Metric)

Bore Diameter 40 – 45 mm

Bore Diameter	OD	Width	Part Number	Type	Bearing Type
40	90	23	7308BEAT85SUN	D	Single Row Angular Contact Ball Bearings
	90	23	7308BW	D	Single Row Angular Contact Ball Bearings
	90	23	7308BWG	D	Single Row Angular Contact Ball Bearings
	90	23	BL308	C	Single Row Radial Ball Bearings
	90	23	BL308NR	C1	Single Row Radial Ball Bearings
	90	23	BL308Z	C2	Single Row Radial Ball Bearings
	90	23	BL308ZNR	C3	Single Row Radial Ball Bearings
	90	23	N308ET	H	Cylindrical Roller Bearings
	90	23	N308W	H	Cylindrical Roller Bearings
	90	23	NF308W	H4	Cylindrical Roller Bearings
	90	23	NJ308EM	H1	Cylindrical Roller Bearings
	90	23	NJ308ET	H1	Cylindrical Roller Bearings
	90	23	NJ308EW	H1	Cylindrical Roller Bearings
	90	23	NU308EM	H2	Cylindrical Roller Bearings
	90	23	NU308ET	H2	Cylindrical Roller Bearings
	90	23	NU308EW	H2	Cylindrical Roller Bearings
	90	23	NUP308ET	H3	Cylindrical Roller Bearings
	90	23	NUP308EW	H3	Cylindrical Roller Bearings
	90	25,25	30308J	F	Tapered Roller Bearings
	90	25,25	31308J	F	Tapered Roller Bearings
	90	33	22308CAME4C4VE	K	Spherical Roller Bearings
	90	33	22308EAE4	K	Spherical Roller Bearings
	90	33	22308EAKE4	K1	Spherical Roller Bearings
	90	33	22308EJW33	K	Spherical Roller Bearings
	90	33	22308EKJW33	K1	Spherical Roller Bearings
	90	33	22308VEC4	K	Spherical Roller Bearings
	90	33	2308J	G	Double Row Self Aligning Ball Bearings
	90	33	2308-2RSTN	G2	Double Row Self Aligning Ball Bearings
	90	33	2308KJ	G1	Double Row Self Aligning Ball Bearings
	90	33	2308KTN	G1	Double Row Self Aligning Ball Bearings
	90	33	2308M	G	Double Row Self Aligning Ball Bearings
	90	33	2308TN	G	Double Row Self Aligning Ball Bearings
	90	33	4308J	L	Double Row Ball Bearings
	90	33	4308BTN	L	Double Row Ball Bearings
	90	33	NJ2308ET	H1	Cylindrical Roller Bearings
	90	33	NJ2308M	H1	Cylindrical Roller Bearings
	90	33	NJ2308W	H1	Cylindrical Roller Bearings
	90	33	NU2308ET	H2	Cylindrical Roller Bearings
	90	33	NU2308W	H2	Cylindrical Roller Bearings
	90	33	NUP2308ET	H3	Cylindrical Roller Bearings
	90	33	NUP2308W	H3	Cylindrical Roller Bearings
	90	35,25	32308J	F	Tapered Roller Bearings
	90	36	51408	E	Thrust Ball Bearings
	90	36,5	3308B-2RSTN	M2	Double Row Angular Contact Ball Bearings
	90	36,5	3308B-2ZNRTN	M4	Double Row Angular Contact Ball Bearings
	90	36,5	3308B-2ZTN	M1	Double Row Angular Contact Ball Bearings
	90	36,5	3308BNRTN	M3	Double Row Angular Contact Ball Bearings
	90	36,5	3308BTN	M	Double Row Angular Contact Ball Bearings
	90	36,5	3308J	M	Double Row Angular Contact Ball Bearings
	90	36,5	3308NRJ	M3	Double Row Angular Contact Ball Bearings
90	36,51	MDJT40M	P	Double Row Angular Contact Ball Bearings	
90	46	7308CTDULP4	D	Super Precision Bearings	
90	46	7308CTDUMP4	D	Super Precision Bearings	
90	46	7308ETDULP4	D	Super Precision Bearings	
90	46	7308ETDUMP4	D	Super Precision Bearings	
45	95	42	53408	E1	Thrust Ball Bearings
	95	58	52310	N	Thrust Ball Bearings
45	100	20	45TAC100BSUC10PN7B	D	Super Precision Bearings
	100	25	1309J	G	Double Row Self Aligning Ball Bearings
	100	25	1309KJ	G1	Double Row Self Aligning Ball Bearings
	100	25	1309KTN	G1	Double Row Self Aligning Ball Bearings

Selection by Dimensions (Metric)

Bore Diameter 45 mm

Bore Diameter	OD	Width	Part Number	Type	Bearing Type
45	100	25	1309TN	G	Double Row Self Aligning Ball Bearings
	100	25	21309EAE4	K	Spherical Roller Bearings
	100	25	21309EAKE4	K1	Spherical Roller Bearings
	100	25	21309J	K	Spherical Roller Bearings
	100	25	21309KJ	K1	Spherical Roller Bearings
	100	25	6309	B	Single Row Radial Ball Bearings
	100	25	6309DDU	B2	Single Row Radial Ball Bearings
	100	25	6309DDUNR	B5	Single Row Radial Ball Bearings
	100	25	6309DU	B2	Single Row Radial Ball Bearings
	100	25	6309M	B	Single Row Radial Ball Bearings
	100	25	6309NR	B3	Single Row Radial Ball Bearings
	100	25	6309TBR12P4	B	Super Precision Bearings
	100	25	6309VV	B6	Single Row Radial Ball Bearings
	100	25	6309Z	B1	Single Row Radial Ball Bearings
	100	25	6309ZNR	B4	Single Row Radial Ball Bearings
	100	25	6309ZZ	B1	Single Row Radial Ball Bearings
	100	25	6309ZZNR	B4	Single Row Radial Ball Bearings
	100	25	7309BEAT85	D	Single Row Angular Contact Ball Bearings
	100	25	7309BEAT85SUN	D	Single Row Angular Contact Ball Bearings
	100	25	7309BW	D	Single Row Angular Contact Ball Bearings
	100	25	7309BWG	D	Single Row Angular Contact Ball Bearings
	100	25	BL309	C	Single Row Radial Ball Bearings
	100	25	BL309NR	C1	Single Row Radial Ball Bearings
	100	25	BL309ZNR	C3	Single Row Radial Ball Bearings
	100	25	N309ET	H	Cylindrical Roller Bearings
	100	25	N309M	H	Cylindrical Roller Bearings
	100	25	N309W	H	Cylindrical Roller Bearings
	100	25	NF309W	H4	Cylindrical Roller Bearings
	100	25	NJ309EM	H1	Cylindrical Roller Bearings
	100	25	NJ309ET	H1	Cylindrical Roller Bearings
	100	25	NJ309EW	H1	Cylindrical Roller Bearings
	100	25	NU309EM	H2	Cylindrical Roller Bearings
	100	25	NU309ET	H2	Cylindrical Roller Bearings
	100	25	NU309EW	H2	Cylindrical Roller Bearings
	100	25	NUP309ET	H3	Cylindrical Roller Bearings
	100	25	NUP309EW	H3	Cylindrical Roller Bearings
	100	25	QJ309M	P2	Duplex Ball Bearings
	100	27,25	30309J	F	Tapered Roller Bearings
	100	27,25	31309J	F	Tapered Roller Bearings
	100	36	22309CAME4C4VE	K	Spherical Roller Bearings
	100	36	22309EAE4	K	Spherical Roller Bearings
	100	36	22309EAKE4	K1	Spherical Roller Bearings
	100	36	22309EJW33	K	Spherical Roller Bearings
	100	36	22309EKJW33	K1	Spherical Roller Bearings
	100	36	22309EMW33	K	Spherical Roller Bearings
	100	36	22309VEC4	K	Spherical Roller Bearings
	100	36	2309J	G	Double Row Self Aligning Ball Bearings
	100	36	2309-2RSTN	G2	Double Row Self Aligning Ball Bearings
	100	36	2309KJ	G1	Double Row Self Aligning Ball Bearings
	100	36	2309KTN	G1	Double Row Self Aligning Ball Bearings
	100	36	2309M	G	Double Row Self Aligning Ball Bearings
	100	36	2309TN	G	Double Row Self Aligning Ball Bearings
	100	36	4309J	L	Double Row Ball Bearings
	100	36	4309BTN	L	Double Row Ball Bearings
	100	36	NJ2309ET	H1	Cylindrical Roller Bearings
	100	36	NJ2309W	H1	Cylindrical Roller Bearings
	100	36	NU2309ET	H2	Cylindrical Roller Bearings
	100	36	NU2309W	H2	Cylindrical Roller Bearings
	100	36	NUP2309ET	H3	Cylindrical Roller Bearings
	100	36	NUP2309M	H3	Cylindrical Roller Bearings
	100	38,25	32309J	F	Tapered Roller Bearings
	100	39	51409	E	Thrust Ball Bearings

Selection by Dimensions (Metric)

Bore Diameter 45 mm

Bore Diameter	OD	Width	Part Number	Type	Bearing Type	
45	100	39,69	MDJK45M	P1	Double Row Angular Contact Ball Bearings	
	100	39,7	3309B-2RSTN	M2	Double Row Angular Contact Ball Bearings	
	100	39,7	3309B-2ZTN	M1	Double Row Angular Contact Ball Bearings	
	100	39,7	3309BNRTN	M3	Double Row Angular Contact Ball Bearings	
	100	39,7	3309BTN	M	Double Row Angular Contact Ball Bearings	
	100	39,7	3309J	M	Double Row Angular Contact Ball Bearings	
	100	39,7	3309NRJ	M3	Double Row Angular Contact Ball Bearings	
	100	40	BSB045100DUHP3	D	Super Precision Bearings	
	100	50	7309CTDULP4	D	Super Precision Bearings	
	100	50	7309ETDULP4	D	Super Precision Bearings	
	100	50	7309ETDUMP4	D	Super Precision Bearings	
		105	46	53409	E1	Thrust Ball Bearings
		105	64	52311	N	Thrust Ball Bearings
	110	78	54311	N1	Thrust Ball Bearings	
	120	29	6409	B	Single Row Radial Ball Bearings	
	120	29	6409AZZ	B1	Single Row Radial Ball Bearings	
	120	29	6409NR	B3	Single Row Radial Ball Bearings	
	120	29	7409BMG	D	Single Row Angular Contact Ball Bearings	
	120	29	N409W	H	Cylindrical Roller Bearings	
	120	29	NJ409M	H1	Cylindrical Roller Bearings	
	120	29	NJ409W	H1	Cylindrical Roller Bearings	
	120	29	NU409M	H2	Cylindrical Roller Bearings	
	120	29	NU409W	H2	Cylindrical Roller Bearings	
	120	29	NUP409M	H3	Cylindrical Roller Bearings	
	120	29	NUP409W	H3	Cylindrical Roller Bearings	
	58	7	6809	B	Single Row Radial Ball Bearings	
	58	7	6809VV	B6	Single Row Radial Ball Bearings	
	58	7	6809ZZ	B1	Single Row Radial Ball Bearings	
	65	14	51109	E	Thrust Ball Bearings	
	68	12	6909	B	Single Row Radial Ball Bearings	
	68	12	6909DDU	B2	Single Row Radial Ball Bearings	
	68	12	6909VV	B6	Single Row Radial Ball Bearings	
	68	12	6909ZZ	B1	Single Row Radial Ball Bearings	
	68	12	7909A5TRV1VSULP3	D	Super Precision Bearings	
	68	12	7909A5TRV1VSUMP3	D	Super Precision Bearings	
	68	12	7909CTRV1VSULP3	D	Super Precision Bearings	
	68	12	7909CTRV1VSUMP3	D	Super Precision Bearings	
	68	24	7909ASTRDULP3	D	Super Precision Bearings	
	68	24	7909ASTRDUMP3	D	Super Precision Bearings	
	68	24	7909CTRDULP3	D	Super Precision Bearings	
	68	24	7909CTRDUMP3	D	Super Precision Bearings	
	73	20	51209	E	Thrust Ball Bearings	
	75	10	16009	B	Single Row Radial Ball Bearings	
	75	16	6009	B	Single Row Radial Ball Bearings	
	75	16	6009DDU	B2	Single Row Radial Ball Bearings	
	75	16	6009DDUNR	B5	Single Row Radial Ball Bearings	
	75	16	6009DU	B2	Single Row Radial Ball Bearings	
	75	16	6009NR	B3	Single Row Radial Ball Bearings	
	75	16	6009TCG12P4	B	Super Precision Bearings	
	75	16	6009TCG12P4	B	Super Precision Bearings	
	75	16	6009VV	B6	Single Row Radial Ball Bearings	
	75	16	6009Z	B1	Single Row Radial Ball Bearings	
	75	16	6009ZNR	B4	Single Row Radial Ball Bearings	
	75	16	6009ZZ	B1	Single Row Radial Ball Bearings	
	75	16	6009ZZNR	B4	Single Row Radial Ball Bearings	
	75	16	7009AM	D	Single Row Angular Contact Ball Bearings	
	75	16	7009A5TRV1VSULP3	D	Super Precision Bearings	
	75	16	7009A5TRV1VSUMP3	D	Super Precision Bearings	
	75	16	7009BM	D	Single Row Angular Contact Ball Bearings	

Selection by Dimensions (Metric)

Bore Diameter 45 mm

Bore Diameter	OD	Width	Part Number	Type	Bearing Type	
45	75	16	7009CTRV1VSULP3	D	Super Precision Bearings	
	75	16	7009CTRV1VSUMP3	D	Super Precision Bearings	
	75	16	NU1009M	H2	Cylindrical Roller Bearings	
	75	20	32009XJ	F	Tapered Roller Bearings	
	75	23	NN3009MBKRCC1P4	I	Super Precision Bearings	
	75	30	BSB045075DUHP3	D	Super Precision Bearings	
	75	32	7009ASTRDULP3	D	Super Precision Bearings	
	75	32	7009ASTRDUMP3	D	Super Precision Bearings	
	75	32	7009CTRDULP3	D	Super Precision Bearings	
	75	32	7009CTRDUMP3	D	Super Precision Bearings	
	75	32	T7009CTDULP3	D	Super Precision Bearings	
	75	39	RS-5009DSE7NAS5	H6	Cylindrical Roller Bearings	
		78	24	53209	E1	Thrust Ball Bearings
		80	26	33109J	F	Tapered Roller Bearings
	85	19	1209J	G	Double Row Self Aligning Ball Bearings	
	85	19	1209KJ	G1	Double Row Self Aligning Ball Bearings	
	85	19	1209KTN	G1	Double Row Self Aligning Ball Bearings	
	85	19	1209TN	G	Double Row Self Aligning Ball Bearings	
	85	19	6209	B	Single Row Radial Ball Bearings	
	85	19	6209DDU	B2	Single Row Radial Ball Bearings	
	85	19	6209DDUNR	B5	Single Row Radial Ball Bearings	
	85	19	6209DU	B2	Single Row Radial Ball Bearings	
	85	19	6209M	B	Single Row Radial Ball Bearings	
	85	19	6209NR	B3	Single Row Radial Ball Bearings	
	85	19	6209TCG12P4	B	Super Precision Bearings	
	85	19	6209TCG12P4	B	Super Precision Bearings	
	85	19	6209VV	B6	Single Row Radial Ball Bearings	
	85	19	6209Z	B1	Single Row Radial Ball Bearings	
	85	19	6209ZNR	B4	Single Row Radial Ball Bearings	
	85	19	6209ZZ	B1	Single Row Radial Ball Bearings	
	85	19	6209ZZNR	B4	Single Row Radial Ball Bearings	
	85	19	7209BEAT85	D	Single Row Angular Contact Ball Bearings	
	85	19	7209BEAT85SUN	D	Single Row Angular Contact Ball Bearings	
	85	19	7209BW	D	Single Row Angular Contact Ball Bearings	
	85	19	7209BWG	D	Single Row Angular Contact Ball Bearings	
	85	19	BL209	C	Single Row Radial Ball Bearings	
	85	19	BL209NR	C1	Single Row Radial Ball Bearings	
	85	19	BL209Z	C2	Single Row Radial Ball Bearings	
	85	19	BL209ZNR	C3	Single Row Radial Ball Bearings	
	85	19	N209ET	H	Cylindrical Roller Bearings	
	85	19	N209W	H	Cylindrical Roller Bearings	
	85	19	NF209ET	H4	Cylindrical Roller Bearings	
	85	19	NF209W	H4	Cylindrical Roller Bearings	
	85	19	NJ209ET	H1	Cylindrical Roller Bearings	
	85	19	NJ209EW	H1	Cylindrical Roller Bearings	
	85	19	NU209EM	H2	Cylindrical Roller Bearings	
	85	19	NU209ET	H2	Cylindrical Roller Bearings	
	85	19	NU209EW	H2	Cylindrical Roller Bearings	
	85	19	NUP209EM	H3	Cylindrical Roller Bearings	
	85	19	NUP209ET	H3	Cylindrical Roller Bearings	
	85	19	NUP209EW	H3	Cylindrical Roller Bearings	
	85	19	QJ209M	P2	Duplex Ball Bearings	
	85	20,75	30209J	F	Tapered Roller Bearings	
	85	23	2209J	G	Double Row Self Aligning Ball Bearings	
	85	23	2209-2RSTN	G2	Double Row Self Aligning Ball Bearings	
	85	23	2209EKTN	G1	Double Row Self Aligning Ball Bearings	
	85	23	2209ETN	G	Double Row Self Aligning Ball Bearings	
	85	23	2209KJ	G1	Double Row Self Aligning Ball Bearings	
85	23	2209K-2RSTN	G3	Double Row Self Aligning Ball Bearings		
85	23	22209EAE4	K	Spherical Roller Bearings		
85	23	22209EAKE4	K1	Spherical Roller Bearings		

Selection by Dimensions (Metric)

Bore Diameter 45 – 50 mm

Bore Diameter	OD	Width	Part Number	Type	Bearing Type
45	85	23	22209EJW33	K	Spherical Roller Bearings
	85	23	22209EKJW33	K1	Spherical Roller Bearings
	85	23	4209J	L	Double Row Ball Bearings
	85	23	4209BTN	L	Double Row Ball Bearings
	85	23	N2209ET	H	Cylindrical Roller Bearings
	85	23	NJ2209ET	H1	Cylindrical Roller Bearings
	85	23	NJ2209W	H1	Cylindrical Roller Bearings
	85	23	NU2209ET	H2	Cylindrical Roller Bearings
	85	23	NU2209W	H2	Cylindrical Roller Bearings
	85	23	NUP2209ET	H3	Cylindrical Roller Bearings
	85	23	NUP2209W	H3	Cylindrical Roller Bearings
	85	24,75	32209J	F	Tapered Roller Bearings
	85	28	51309	E	Thrust Ball Bearings
	85	30,2	3209J	M	Double Row Angular Contact Ball Bearings
	85	30,2	3209B-2RSTN	M2	Double Row Angular Contact Ball Bearings
	85	30,2	3209B-2ZTN	M1	Double Row Angular Contact Ball Bearings
	85	30,2	3209BTN	M	Double Row Angular Contact Ball Bearings
	85	32	33209J	F	Tapered Roller Bearings
	85	38	7209ASTRDULP3	D	Super Precision Bearings
	85	38	7209ASTRDUMP3	D	Super Precision Bearings
85	38	7209CTRDULP3	D	Super Precision Bearings	
85	38	7209CTRDUMP3	D	Super Precision Bearings	
85	58	11209TN	G4	Double Row Self Aligning Ball Bearings	
	90	33	53309	E1	Thrust Ball Bearings
	90	45	52211	N	Thrust Ball Bearings
	95	55	54211	N1	Thrust Ball Bearings
50	100	37	53310	E1	Thrust Ball Bearings
	100	40	BSB050100DUHP3	D	Super Precision Bearings
	100	56	54212	N1	Thrust Ball Bearings
	110	27	1310J	G	Double Row Self Aligning Ball Bearings
	110	27	1310KJ	G1	Double Row Self Aligning Ball Bearings
	110	27	1310KTN	G1	Double Row Self Aligning Ball Bearings
	110	27	1310TN	G	Double Row Self Aligning Ball Bearings
	110	27	21310EAE4	K	Spherical Roller Bearings
	110	27	21310EAKE4	K1	Spherical Roller Bearings
	110	27	21310J	K	Spherical Roller Bearings
	110	27	21310KJ	K1	Spherical Roller Bearings
	110	27	6310	B	Single Row Radial Ball Bearings
	110	27	6310DDU	B2	Single Row Radial Ball Bearings
	110	27	6310DDUNR	B5	Single Row Radial Ball Bearings
	110	27	6310DU	B2	Single Row Radial Ball Bearings
	110	27	6310M	B	Single Row Radial Ball Bearings
	110	27	6310N	B3	Single Row Radial Ball Bearings
	110	27	6310NR	B3	Single Row Radial Ball Bearings
	110	27	6310TBR12P4	B	Super Precision Bearings
	110	27	6310VV	B6	Single Row Radial Ball Bearings
	110	27	6310Z	B1	Single Row Radial Ball Bearings
	110	27	6310ZNR	B4	Single Row Radial Ball Bearings
	110	27	6310ZZ	B1	Single Row Radial Ball Bearings
	110	27	6310ZZNR	B4	Single Row Radial Ball Bearings
	110	27	7310BEAT85	D	Single Row Angular Contact Ball Bearings
	110	27	7310BEAT85SUN	D	Single Row Angular Contact Ball Bearings
	110	27	7310BW	D	Single Row Angular Contact Ball Bearings
	110	27	7310BWG	D	Single Row Angular Contact Ball Bearings
	110	27	BL310	C	Single Row Radial Ball Bearings
	110	27	BL310NR	C1	Single Row Radial Ball Bearings
	110	27	BL310ZNR	C3	Single Row Radial Ball Bearings
	110	27	BL310ZZ	C2	Single Row Radial Ball Bearings
	110	27	N310ET	H	Cylindrical Roller Bearings
110	27	N310M	H	Cylindrical Roller Bearings	
110	27	N310W	H	Cylindrical Roller Bearings	

Selection by Dimensions (Metric)

Bore Diameter 50 mm

Bore Diameter	OD	Width	Part Number	Type	Bearing Type
50	110	27	NF310ET	H4	Cylindrical Roller Bearings
	110	27	NF310W	H4	Cylindrical Roller Bearings
	110	27	NJ310ET	H1	Cylindrical Roller Bearings
	110	27	NJ310EW	H1	Cylindrical Roller Bearings
	110	27	NU310EM	H2	Cylindrical Roller Bearings
	110	27	NU310ET	H2	Cylindrical Roller Bearings
	110	27	NU310EW	H2	Cylindrical Roller Bearings
	110	27	NUP310ET	H3	Cylindrical Roller Bearings
	110	27	NUP310EW	H3	Cylindrical Roller Bearings
	110	29,25	30310J	F	Tapered Roller Bearings
	110	29,25	31310J	F	Tapered Roller Bearings
	110	40	22310CAME4C4VE	K	Spherical Roller Bearings
	110	40	22310EAE4	K	Spherical Roller Bearings
	110	40	22310EAKE4	K1	Spherical Roller Bearings
	110	40	22310EJW33	K	Spherical Roller Bearings
	110	40	22310EKJW33	K1	Spherical Roller Bearings
	110	40	22310VEC4	K	Spherical Roller Bearings
	110	40	2310J	G	Double Row Self Aligning Ball Bearings
	110	40	2310-2RSTN	G2	Double Row Self Aligning Ball Bearings
	110	40	2310KJ	G1	Double Row Self Aligning Ball Bearings
	110	40	2310KTN	G1	Double Row Self Aligning Ball Bearings
	110	40	2310TN	G	Double Row Self Aligning Ball Bearings
	110	40	4310J	L	Double Row Ball Bearings
	110	40	4310BTN	L	Double Row Ball Bearings
	110	40	NJ2310ET	H1	Cylindrical Roller Bearings
	110	40	NJ2310M	H1	Cylindrical Roller Bearings
	110	40	NJ2310W	H1	Cylindrical Roller Bearings
	110	40	NU2310ET	H2	Cylindrical Roller Bearings
	110	40	NU2310M	H2	Cylindrical Roller Bearings
	110	40	NU2310W	H2	Cylindrical Roller Bearings
	110	40	NUP2310ET	H3	Cylindrical Roller Bearings
	110	40	NUP2310W	H3	Cylindrical Roller Bearings
	110	42,25	32310J	F	Tapered Roller Bearings
	110	43	51410	E	Thrust Ball Bearings
	110	44,4	3310B-2RSTN	M2	Double Row Angular Contact Ball Bearings
	110	44,4	3310B-2ZTN	M1	Double Row Angular Contact Ball Bearings
	110	44,4	3310BNRTN	M3	Double Row Angular Contact Ball Bearings
	110	44,4	3310BTN	M	Double Row Angular Contact Ball Bearings
	110	44,4	3310J	M	Double Row Angular Contact Ball Bearings
	110	44,4	3310NRJ	M3	Double Row Angular Contact Ball Bearings
	110	54	7310CTDULP4	D	Super Precision Bearings
	110	54	7310ETDULP4	D	Super Precision Bearings
	110	54	7310ETDUMP4	D	Super Precision Bearings
	110	64	52312	N	Thrust Ball Bearings
	115	50	53410	E1	Thrust Ball Bearings
	115	78	54312	N1	Thrust Ball Bearings
	130	31	6410	B	Single Row Radial Ball Bearings
	130	31	6410NR	B3	Single Row Radial Ball Bearings
	130	31	6410ZZ	B1	Single Row Radial Ball Bearings
	130	31	7410BMG	D	Single Row Angular Contact Ball Bearings
	130	31	N410W	H	Cylindrical Roller Bearings
	130	31	NF410W	H4	Cylindrical Roller Bearings
	130	31	NJ410W	H1	Cylindrical Roller Bearings
	130	31	NU410W	H2	Cylindrical Roller Bearings
	135	107	54412	N1	Thrust Ball Bearings
	145	119	54413	N1	Thrust Ball Bearings
	65	7	6810	B	Single Row Radial Ball Bearings
	65	7	6810VV	B6	Single Row Radial Ball Bearings
	65	7	6810ZZ	B1	Single Row Radial Ball Bearings
	70	14	51110	E	Thrust Ball Bearings

Selection by Dimensions (Metric)

Bore Diameter 50 mm

Bore Diameter	OD	Width	Part Number	Type	Bearing Type
50	72	12	6910	B	Single Row Radial Ball Bearings
	72	12	6910DDU	B2	Single Row Radial Ball Bearings
	72	12	6910VV	B6	Single Row Radial Ball Bearings
	72	12	6910ZZ	B1	Single Row Radial Ball Bearings
	72	12	7910ASTRV1VSULP3	D	Super Precision Bearings
	72	12	7910ASTRV1VSUMP3	D	Super Precision Bearings
	72	12	7910CTRV1VSULP3	D	Super Precision Bearings
	72	12	7910CTRV1VSUMP3	D	Super Precision Bearings
	72	24	7910ASTRDULP3	D	Super Precision Bearings
	72	24	7910ASTRDUMP3	D	Super Precision Bearings
	72	24	7910CTRDULP3	D	Super Precision Bearings
	72	24	7910CTRDUMP3	D	Super Precision Bearings
		78	22	51210	E
	80	10	16010	B	Single Row Radial Ball Bearings
	80	16	6010	B	Single Row Radial Ball Bearings
	80	16	6010DDU	B2	Single Row Radial Ball Bearings
	80	16	6010DDUNR	B5	Single Row Radial Ball Bearings
	80	16	6010DU	B2	Single Row Radial Ball Bearings
	80	16	6010NR	B3	Single Row Radial Ball Bearings
	80	16	6010TCG12P4	B	Super Precision Bearings
	80	16	6010TCG12P4	B	Super Precision Bearings
	80	16	6010VV	B6	Single Row Radial Ball Bearings
	80	16	6010Z	B1	Single Row Radial Ball Bearings
	80	16	6010ZNR	B4	Single Row Radial Ball Bearings
	80	16	6010ZZ	B1	Single Row Radial Ball Bearings
	80	16	6010ZZNR	B4	Single Row Radial Ball Bearings
	80	16	7010AM	D	Single Row Angular Contact Ball Bearings
	80	16	7010ASTRV1VSULP3	D	Super Precision Bearings
	80	16	7010ASTRV1VSUMP3	D	Super Precision Bearings
	80	16	7010BM	D	Single Row Angular Contact Ball Bearings
	80	16	7010CTRV1VSULP3	D	Super Precision Bearings
	80	16	7010CTRV1VSUMP3	D	Super Precision Bearings
	80	16	NU1010M	H2	Cylindrical Roller Bearings
	80	20	32010XJ	F	Tapered Roller Bearings
	80	23	NN3010MBKRCC1P4	I	Super Precision Bearings
	80	24	33010J	F	Tapered Roller Bearings
	80	32	7010ASTRDULP3	D	Super Precision Bearings
	80	32	7010ASTRDUMP3	D	Super Precision Bearings
	80	32	7010CTRDULP3	D	Super Precision Bearings
	80	32	7010CTRDUMP3	D	Super Precision Bearings
	80	32	T7010CTDULP3	D	Super Precision Bearings
	80	39	RS-5010DSE7NAS5	H6	Cylindrical Roller Bearings
	82	26	53210	E1	Thrust Ball Bearings
	85	26	33110J	F	Tapered Roller Bearings
	90	20	1210J	G	Double Row Self Aligning Ball Bearings
	90	20	1210KJ	G1	Double Row Self Aligning Ball Bearings
	90	20	1210KTN	G1	Double Row Self Aligning Ball Bearings
	90	20	1210TN	G	Double Row Self Aligning Ball Bearings
	90	20	6210	B	Single Row Radial Ball Bearings
	90	20	6210DDU	B2	Single Row Radial Ball Bearings
	90	20	6210DDUNR	B5	Single Row Radial Ball Bearings
	90	20	6210DU	B2	Single Row Radial Ball Bearings
	90	20	6210M	B	Single Row Radial Ball Bearings
	90	20	6210NR	B3	Single Row Radial Ball Bearings
	90	20	6210TCG12P4	B	Super Precision Bearings
	90	20	6210TCG12P4	B	Super Precision Bearings
	90	20	6210VV	B6	Single Row Radial Ball Bearings
	90	20	6210Z	B1	Single Row Radial Ball Bearings
	90	20	6210ZNR	B4	Single Row Radial Ball Bearings
	90	20	6210ZZ	B1	Single Row Radial Ball Bearings

Selection by Dimensions (Metric)

Bore Diameter 50 – 55 mm

Bore Diameter	OD	Width	Part Number	Type	Bearing Type
50	90	20	6210ZZNR	B4	Single Row Radial Ball Bearings
	90	20	7210BEAT85	D	Single Row Angular Contact Ball Bearings
	90	20	7210BEAT84SUN	D	Single Row Angular Contact Ball Bearings
	90	20	7210BW	D	Single Row Angular Contact Ball Bearings
	90	20	7210BWG	D	Single Row Angular Contact Ball Bearings
	90	20	BL210	C	Single Row Radial Ball Bearings
	90	20	BL210NR	C1	Single Row Radial Ball Bearings
	90	20	BL210Z	C2	Single Row Radial Ball Bearings
	90	20	BL210ZNR	C3	Single Row Radial Ball Bearings
	90	20	BL210ZZ	C2	Single Row Radial Ball Bearings
	90	20	N210ET	H	Cylindrical Roller Bearings
	90	20	N210M	H	Cylindrical Roller Bearings
	90	20	N210W	H	Cylindrical Roller Bearings
	90	20	NF210ET	H4	Cylindrical Roller Bearings
	90	20	NF210W	H4	Cylindrical Roller Bearings
	90	20	NJ210ET	H1	Cylindrical Roller Bearings
	90	20	NJ210EW	H1	Cylindrical Roller Bearings
	90	20	NU210EM	H2	Cylindrical Roller Bearings
	90	20	NU210ET	H2	Cylindrical Roller Bearings
	90	20	NU210EW	H2	Cylindrical Roller Bearings
	90	20	NUP210ET	H3	Cylindrical Roller Bearings
	90	20	NUP210EW	H3	Cylindrical Roller Bearings
	90	21,75	30210J	F	Tapered Roller Bearings
	90	23	2210J	G	Double Row Self Aligning Ball Bearings
	90	23	2210-2RSTN	G2	Double Row Self Aligning Ball Bearings
	90	23	2210EKTN	G1	Double Row Self Aligning Ball Bearings
	90	23	2210ETN	G	Double Row Self Aligning Ball Bearings
	90	23	2210KJ	G1	Double Row Self Aligning Ball Bearings
	90	23	2210K-2RSTN	G3	Double Row Self Aligning Ball Bearings
	90	23	22210EAE4	K	Spherical Roller Bearings
	90	23	22210EAKE4	K1	Spherical Roller Bearings
	90	23	22210EJW33	K	Spherical Roller Bearings
	90	23	22210EKJW33	K1	Spherical Roller Bearings
	90	23	4210J	L	Double Row Ball Bearings
	90	23	4210BTN	L	Double Row Ball Bearings
	90	23	NF2210W	H4	Cylindrical Roller Bearings
	90	23	NJ2210ET	H1	Cylindrical Roller Bearings
	90	23	NJ2210W	H1	Cylindrical Roller Bearings
	90	23	NU2210ET	H2	Cylindrical Roller Bearings
	90	23	NU2210M	H2	Cylindrical Roller Bearings
	90	23	NU2210W	H2	Cylindrical Roller Bearings
	90	23	NUP2210ET	H3	Cylindrical Roller Bearings
	90	23	NUP2210M	H3	Cylindrical Roller Bearings
	90	24,75	32210J	F	Tapered Roller Bearings
	90	30,16	LDJT50M	P	Double Row Angular Contact Ball Bearings
	90	30,2	3210B-2RSTN	M2	Double Row Angular Contact Ball Bearings
	90	30,2	3210B-2ZTN	M1	Double Row Angular Contact Ball Bearings
	90	30,2	3210BNRTN	M3	Double Row Angular Contact Ball Bearings
	90	30,2	3210BTN	M	Double Row Angular Contact Ball Bearings
	90	30,2	3210J	M	Double Row Angular Contact Ball Bearings
	90	32	33210J	F	Tapered Roller Bearings
	90	40	7210ASTRDULP3	D	Super Precision Bearings
	90	40	7210ASTRDUMP3	D	Super Precision Bearings
	90	40	7210CTRDULP3	D	Super Precision Bearings
	90	40	7210CTRDUMP3	D	Super Precision Bearings
	90	58	11210TN	G4	Double Row Self Aligning Ball Bearings
	95	31	51310	E	Thrust Ball Bearings
	95	46	52212	N	Thrust Ball Bearings
55	100	21	1211J	G	Double Row Self Aligning Ball Bearings
	100	21	1211KJ	G1	Double Row Self Aligning Ball Bearings
	100	21	1211KTN	G1	Double Row Self Aligning Ball Bearings
	100	21	1211TN	G	Double Row Self Aligning Ball Bearings

Selection by Dimensions (Metric)

Bore Diameter 55 mm

Bore Diameter	OD	Width	Part Number	Type	Bearing Type
55	100	21	6211	B	Single Row Radial Ball Bearings
	100	21	6211DDU	B2	Single Row Radial Ball Bearings
	100	21	6211DDUNR	B5	Single Row Radial Ball Bearings
	100	21	6211DU	B2	Single Row Radial Ball Bearings
	100	21	6211M	B	Single Row Radial Ball Bearings
	100	21	6211NR	B3	Single Row Radial Ball Bearings
	100	21	6211TCG12P4	B	Super Precision Bearings
	100	21	6211TCG12P4	B	Super Precision Bearings
	100	21	6211VV	B6	Single Row Radial Ball Bearings
	100	21	6211Z	B1	Single Row Radial Ball Bearings
	100	21	6211ZNR	B4	Single Row Radial Ball Bearings
	100	21	6211ZZ	B1	Single Row Radial Ball Bearings
	100	21	6211ZZNR	B4	Single Row Radial Ball Bearings
	100	21	7211BEAT85	D	Single Row Angular Contact Ball Bearings
	100	21	7211BEAT85SUN	D	Single Row Angular Contact Ball Bearings
	100	21	7211BW	D	Single Row Angular Contact Ball Bearings
	100	21	7211BWG	D	Single Row Angular Contact Ball Bearings
	100	21	BL211	C	Single Row Radial Ball Bearings
	100	21	BL211NR	C1	Single Row Radial Ball Bearings
	100	21	BL211ZNR	C3	Single Row Radial Ball Bearings
	100	21	BL211ZZ	C2	Single Row Radial Ball Bearings
	100	21	N211ET	H	Cylindrical Roller Bearings
	100	21	N211W	H	Cylindrical Roller Bearings
	100	21	NF211ET	H4	Cylindrical Roller Bearings
	100	21	NF211W	H4	Cylindrical Roller Bearings
	100	21	NJ211ET	H1	Cylindrical Roller Bearings
	100	21	NJ211EW	H1	Cylindrical Roller Bearings
	100	21	NU211EM	H2	Cylindrical Roller Bearings
	100	21	NU211ET	H2	Cylindrical Roller Bearings
	100	21	NU211EW	H2	Cylindrical Roller Bearings
	100	21	NUP211ET	H3	Cylindrical Roller Bearings
	100	21	NUP211EW	H3	Cylindrical Roller Bearings
	100	22,75	30211J	F	Tapered Roller Bearings
	100	25	2211J	G	Double Row Self Aligning Ball Bearings
	100	25	2211-2RSTN	G2	Double Row Self Aligning Ball Bearings
	100	25	2211EKTN	G1	Double Row Self Aligning Ball Bearings
	100	25	2211ETN	G	Double Row Self Aligning Ball Bearings
	100	25	2211KJ	G1	Double Row Self Aligning Ball Bearings
	100	25	2211K-2RSTN	G3	Double Row Self Aligning Ball Bearings
	100	25	22211EAE4	K	Spherical Roller Bearings
	100	25	22211EAKE4	K1	Spherical Roller Bearings
	100	25	22211EJW33	K	Spherical Roller Bearings
	100	25	22211EKJW33	K1	Spherical Roller Bearings
	100	25	4211J	L	Double Row Ball Bearings
	100	25	4211BTN	L	Double Row Ball Bearings
	100	25	NJ2211ET	H1	Cylindrical Roller Bearings
	100	25	NJ2211M	H1	Cylindrical Roller Bearings
	100	25	NJ2211W	H1	Cylindrical Roller Bearings
	100	25	NU2211ET	H2	Cylindrical Roller Bearings
	100	25	NU2211M	H2	Cylindrical Roller Bearings
	100	25	NU2211W	H2	Cylindrical Roller Bearings
	100	25	NUP2211ET	H3	Cylindrical Roller Bearings
	100	25	NUP2211M	H3	Cylindrical Roller Bearings
	100	25	NUP2211W	H3	Cylindrical Roller Bearings
	100	26,75	32211J	F	Tapered Roller Bearings
	100	33,3	3211B-2RSTN	M2	Double Row Angular Contact Ball Bearings
	100	33,3	3211B-2ZTN	M1	Double Row Angular Contact Ball Bearings
	100	33,3	3211BTN	M	Double Row Angular Contact Ball Bearings
	100	33,3	3211J	M	Double Row Angular Contact Ball Bearings
	100	33,34	LDJT55M	P	Double Row Angular Contact Ball Bearings
	100	35	33211J	F	Tapered Roller Bearings
	100	42	7211ASTRDULP3	D	Super Precision Bearings

Selection by Dimensions (Metric)

Bore Diameter 55 mm

Bore Diameter	OD	Width	Part Number	Type	Bearing Type
55	100	42	7211ASTRDUMP3	D	Super Precision Bearings
	100	42	7211CTRDULP3	D	Super Precision Bearings
	100	42	7211CTRDUMP3	D	Super Precision Bearings
	100	47	52213	N	Thrust Ball Bearings
	100	60	11211TN	G4	Double Row Self Aligning Ball Bearings
	105	35	51311	E	Thrust Ball Bearings
	105	47	52214	N	Thrust Ball Bearings
	110	42	53311	E1	Thrust Ball Bearings
	115	65	52313	N	Thrust Ball Bearings
	120	29	1311J	G	Double Row Self Aligning Ball Bearings
	120	29	1311KJ	G1	Double Row Self Aligning Ball Bearings
	120	29	1311KTN	G1	Double Row Self Aligning Ball Bearings
	120	29	1311TN	G	Double Row Self Aligning Ball Bearings
	120	29	21311EAE4	K	Spherical Roller Bearings
	120	29	21311EAKE4	K1	Spherical Roller Bearings
	120	29	21311J	K	Spherical Roller Bearings
	120	29	21311KJ	K1	Spherical Roller Bearings
	120	29	6311	B	Single Row Radial Ball Bearings
	120	29	6311DDU	B2	Single Row Radial Ball Bearings
	120	29	6311DDUNR	B5	Single Row Radial Ball Bearings
	120	29	6311DU	B2	Single Row Radial Ball Bearings
	120	29	6311M	B	Single Row Radial Ball Bearings
	120	29	6311N	B3	Single Row Radial Ball Bearings
	120	29	6311NR	B3	Single Row Radial Ball Bearings
	120	29	6311TBR12P4	B	Super Precision Bearings
	120	29	6311VV	B6	Single Row Radial Ball Bearings
	120	29	6311Z	B1	Single Row Radial Ball Bearings
	120	29	6311ZNR	B4	Single Row Radial Ball Bearings
	120	29	6311ZZ	B1	Single Row Radial Ball Bearings
	120	29	6311ZZNR	B4	Single Row Radial Ball Bearings
	120	29	7311BEAT85	D	Single Row Angular Contact Ball Bearings
	120	29	7311BEAT85SUN	D	Single Row Angular Contact Ball Bearings
	120	29	7311BW	D	Single Row Angular Contact Ball Bearings
	120	29	7311BWG	D	Single Row Angular Contact Ball Bearings
	120	29	BL311NR	C1	Single Row Radial Ball Bearings
	120	29	BL311ZNR	C3	Single Row Radial Ball Bearings
	120	29	N311ET	H	Cylindrical Roller Bearings
	120	29	N311W	H	Cylindrical Roller Bearings
	120	29	NF311M	H4	Cylindrical Roller Bearings
	120	29	NF311W	H4	Cylindrical Roller Bearings
	120	29	NJ311ET	H1	Cylindrical Roller Bearings
	120	29	NJ311EW	H1	Cylindrical Roller Bearings
	120	29	NU311EM	H2	Cylindrical Roller Bearings
	120	29	NU311ET	H2	Cylindrical Roller Bearings
	120	29	NU311EW	H2	Cylindrical Roller Bearings
	120	29	NUP311ET	H3	Cylindrical Roller Bearings
	120	29	NUP311EW	H3	Cylindrical Roller Bearings
	120	31,5	30311J	F	Tapered Roller Bearings
	120	31,5	31311J	F	Tapered Roller Bearings
	120	40	BSB055120DUHP3	D	Super Precision Bearings
	120	43	22311CAME4C4VE	K	Spherical Roller Bearings
	120	43	22311EAE4	K	Spherical Roller Bearings
	120	43	22311EAKE4	K1	Spherical Roller Bearings
	120	43	22311EJW33	K	Spherical Roller Bearings
	120	43	22311EKJW33	K1	Spherical Roller Bearings
	120	43	22311VEC4	K	Spherical Roller Bearings
	120	43	2311J	G	Double Row Self Aligning Ball Bearings
	120	43	2311KJ	G1	Double Row Self Aligning Ball Bearings
	120	43	2311KTN	G1	Double Row Self Aligning Ball Bearings
	120	43	2311M	G	Double Row Self Aligning Ball Bearings
	120	43	2311TN	G	Double Row Self Aligning Ball Bearings

Selection by Dimensions (Metric)

Bore Diameter 55 mm

Bore Diameter	OD	Width	Part Number	Type	Bearing Type
55	120	43	4311BTN	L	Double Row Ball Bearings
	120	43	NJ2311W	H1	Cylindrical Roller Bearings
	120	43	NU2311ET	H2	Cylindrical Roller Bearings
	120	43	NU2311M	H2	Cylindrical Roller Bearings
	120	43	NU2311W	H2	Cylindrical Roller Bearings
	120	43	NUP2311M	H3	Cylindrical Roller Bearings
	120	45,5	32311J	F	Tapered Roller Bearings
	120	48	51411	E	Thrust Ball Bearings
	120	49,2	3311B-2RSTN	M2	Double Row Angular Contact Ball Bearings
	120	49,2	3311B-2ZTN	M1	Double Row Angular Contact Ball Bearings
	120	49,2	3311BNRTN	M3	Double Row Angular Contact Ball Bearings
	120	49,2	3311BTN	M	Double Row Angular Contact Ball Bearings
	120	49,2	3311J	M	Double Row Angular Contact Ball Bearings
	120	58	7311CTDULP4	D	Super Precision Bearings
	120	58	7311CTDUMP4	D	Super Precision Bearings
	120	58	7311ETDULP4	D	Super Precision Bearings
	120	58	7311ETDUMP4	D	Super Precision Bearings
		120	79	54313	N1
	125	55	53411	E1	Thrust Ball Bearings
	125	72	52314	N	Thrust Ball Bearings
	130	88	54314	N1	Thrust Ball Bearings
	140	33	6411	B	Single Row Radial Ball Bearings
	140	33	6411ZZ	B1	Single Row Radial Ball Bearings
	140	33	6411NR	B3	Single Row Radial Ball Bearings
	140	33	7411BM	D	Single Row Angular Contact Ball Bearings
	140	33	7411BMG	D	Single Row Angular Contact Ball Bearings
	140	33	NJ411W	H1	Cylindrical Roller Bearings
	140	33	NU411W	H2	Cylindrical Roller Bearings
	72	9	6811	B	Single Row Radial Ball Bearings
	72	9	6811VV	B6	Single Row Radial Ball Bearings
	72	9	6811ZZ	B1	Single Row Radial Ball Bearings
	78	16	51111	E	Thrust Ball Bearings
	80	13	6911	B	Single Row Radial Ball Bearings
	80	13	6911VV	B6	Single Row Radial Ball Bearings
	80	13	6911ZZ	B1	Single Row Radial Ball Bearings
	80	13	7911A5TRV1VSULP3	D	Super Precision Bearings
	80	13	7911A5TRV1VSUMP3	D	Super Precision Bearings
	80	13	7911CTRV1VSULP3	D	Super Precision Bearings
	80	13	7911CTRV1VSUMP3	D	Super Precision Bearings
	80	26	7911A5TRDULP3	D	Super Precision Bearings
	80	26	7911A5TRDUMP3	D	Super Precision Bearings
	80	26	7911CTRDULP3	D	Super Precision Bearings
	80	26	7911CTRDUMP3	D	Super Precision Bearings
	90	11	16011	B	Single Row Radial Ball Bearings
	90	18	6011	B	Single Row Radial Ball Bearings
	90	18	6011DDU	B2	Single Row Radial Ball Bearings
	90	18	6011DDUNR	B5	Single Row Radial Ball Bearings
	90	18	6011DU	B2	Single Row Radial Ball Bearings
	90	18	6011M	B	Single Row Radial Ball Bearings
	90	18	6011NR	B3	Single Row Radial Ball Bearings
	90	18	6011TCG12P4	B	Super Precision Bearings
	90	18	6011TCG12P4	B	Super Precision Bearings
	90	18	6011VV	B6	Single Row Radial Ball Bearings
	90	18	6011Z	B1	Single Row Radial Ball Bearings
	90	18	6011ZNR	B4	Single Row Radial Ball Bearings
	90	18	6011ZZ	B1	Single Row Radial Ball Bearings
	90	18	6011ZZNR	B4	Single Row Radial Ball Bearings
	90	18	7011A5TRV1VSULP3	D	Super Precision Bearings
	90	18	7011A5TRV1VSUMP3	D	Super Precision Bearings

Selection by Dimensions (Metric)

Bore Diameter 55 – 60 mm

Bore Diameter	OD	Width	Part Number	Type	Bearing Type
55	90	18	7011AW	D	Single Row Angular Contact Ball Bearings
	90	18	7011BM	D	Single Row Angular Contact Ball Bearings
	90	18	7011CTRV1VSULP3	D	Super Precision Bearings
	90	18	7011CTRV1VSUMP3	D	Super Precision Bearings
	90	18	NU1011M	H2	Cylindrical Roller Bearings
	90	23	32011XJ	F	Tapered Roller Bearings
	90	25	51211	E	Thrust Ball Bearings
	90	26	NN3011MBKRCC1P4	I	Super Precision Bearings
	90	27	33011J	F	Tapered Roller Bearings
	90	30	BSB055090DUHP3	D	Super Precision Bearings
	90	36	7011ASTRDULP3	D	Super Precision Bearings
	90	36	7011ASTRDUMP3	D	Super Precision Bearings
	90	36	7011CTRDULP3	D	Super Precision Bearings
	90	36	7011CTRDUMP3	D	Super Precision Bearings
	90	36	T7011CTDULP3	D	Super Precision Bearings
	90	45	RS-5011DSE7NASS	H6	Cylindrical Roller Bearings
	95	30	53211	E1	Thrust Ball Bearings
	95	30	33111J	F	Tapered Roller Bearings
60	100	31	53212	E1	Thrust Ball Bearings
	110	22	1212J	G	Double Row Self Aligning Ball Bearings
	110	22	1212KJ	G1	Double Row Self Aligning Ball Bearings
	110	22	1212KTN	G1	Double Row Self Aligning Ball Bearings
	110	22	1212TN	G	Double Row Self Aligning Ball Bearings
	110	22	6212	B	Single Row Radial Ball Bearings
	110	22	6212DDU	B2	Single Row Radial Ball Bearings
	110	22	6212DDUNR	B5	Single Row Radial Ball Bearings
	110	22	6212DU	B2	Single Row Radial Ball Bearings
	110	22	6212M	B	Single Row Radial Ball Bearings
	110	22	6212NR	B3	Single Row Radial Ball Bearings
	110	22	6212TCG12P4	B	Super Precision Bearings
	110	22	6212TCG12P4	B	Super Precision Bearings
	110	22	6212VV	B6	Single Row Radial Ball Bearings
	110	22	6212Z	B1	Single Row Radial Ball Bearings
	110	22	6212ZNR	B4	Single Row Radial Ball Bearings
	110	22	6212ZZ	B1	Single Row Radial Ball Bearings
	110	22	6212ZZNR	B4	Single Row Radial Ball Bearings
	110	22	7212BEAT85	D	Single Row Angular Contact Ball Bearings
	110	22	7212BEAT85SUN	D	Single Row Angular Contact Ball Bearings
	110	22	7212BW	D	Single Row Angular Contact Ball Bearings
	110	22	7212BWG	D	Single Row Angular Contact Ball Bearings
	110	22	BL212NR	C1	Single Row Radial Ball Bearings
	110	22	BL212Z	C2	Single Row Radial Ball Bearings
	110	22	BL212ZNR	C3	Single Row Radial Ball Bearings
	110	22	BL212ZZ	C2	Single Row Radial Ball Bearings
	110	22	N212ET	H	Cylindrical Roller Bearings
	110	22	N212W	H	Cylindrical Roller Bearings
	110	22	NF212W	H4	Cylindrical Roller Bearings
	110	22	NJ212ET	H1	Cylindrical Roller Bearings
	110	22	NJ212EW	H1	Cylindrical Roller Bearings
	110	22	NU212EM	H2	Cylindrical Roller Bearings
	110	22	NU212ET	H2	Cylindrical Roller Bearings
	110	22	NU212EW	H2	Cylindrical Roller Bearings
	110	22	NUP212ET	H3	Cylindrical Roller Bearings
	110	22	NUP212EW	H3	Cylindrical Roller Bearings
	110	23,75	30212J	F	Tapered Roller Bearings
	110	28	2212J	G	Double Row Self Aligning Ball Bearings
	110	28	2212-2RSTN	G2	Double Row Self Aligning Ball Bearings
	110	28	2212EKTN	G1	Double Row Self Aligning Ball Bearings
	110	28	2212ETN	G	Double Row Self Aligning Ball Bearings
110	28	2212KJ	G1	Double Row Self Aligning Ball Bearings	
110	28	22212EAE4	K	Spherical Roller Bearings	

Selection by Dimensions (Metric)

Bore Diameter 60 mm

Bore Diameter	OD	Width	Part Number	Type	Bearing Type
60	110	28	22212EAKE4	K1	Spherical Roller Bearings
	110	28	22212EJW33	K	Spherical Roller Bearings
	110	28	22212EKJW33	K1	Spherical Roller Bearings
	110	28	4212J	L	Double Row Ball Bearings
	110	28	4212BTN	L	Double Row Ball Bearings
	110	28	NJ2212ET	H1	Cylindrical Roller Bearings
	110	28	NJ2212W	H1	Cylindrical Roller Bearings
	110	28	NU2212ET	H2	Cylindrical Roller Bearings
	110	28	NU2212M	H2	Cylindrical Roller Bearings
	110	28	NU2212W	H2	Cylindrical Roller Bearings
	110	28	NUP2212ET	H3	Cylindrical Roller Bearings
	110	28	NUP2212W	H3	Cylindrical Roller Bearings
	110	29,75	32212J	F	Tapered Roller Bearings
	110	35	51312	E	Thrust Ball Bearings
	110	36,5	3212B-2RSTN	M2	Double Row Angular Contact Ball Bearings
	110	36,5	3212B-2ZTN	M1	Double Row Angular Contact Ball Bearings
	110	36,5	3212BTN	M	Double Row Angular Contact Ball Bearings
	110	36,5	3212WA	M	Double Row Angular Contact Ball Bearings
	110	36,51	LDJT60M	P	Double Row Angular Contact Ball Bearings
	110	38	33212J	F	Tapered Roller Bearings
	110	44	7212ASTRDULP3	D	Super Precision Bearings
	110	44	7212ASTRDUMP3	D	Super Precision Bearings
	110	44	7212CTRDULP3	D	Super Precision Bearings
	110	44	7212CTRDUMP3	D	Super Precision Bearings
	110	47	52215	N	Thrust Ball Bearings
	110	62	11212TN	G4	Double Row Self Aligning Ball Bearings
	115	42	53312	E1	Thrust Ball Bearings
	120	40	BSB060120DUHP3	D	Super Precision Bearings
	130	31	1312J	G	Double Row Self Aligning Ball Bearings
	130	31	1312KJ	G1	Double Row Self Aligning Ball Bearings
	130	31	21312EAE4	K	Spherical Roller Bearings
	130	31	21312EAKE4	K1	Spherical Roller Bearings
	130	31	21312J	K	Spherical Roller Bearings
	130	31	21312KJ	K1	Spherical Roller Bearings
	130	31	6312	B	Single Row Radial Ball Bearings
	130	31	6312DDU	B2	Single Row Radial Ball Bearings
	130	31	6312DDUNR	B5	Single Row Radial Ball Bearings
	130	31	6312DU	B2	Single Row Radial Ball Bearings
	130	31	6312M	B	Single Row Radial Ball Bearings
	130	31	6312NR	B3	Single Row Radial Ball Bearings
	130	31	6312TBR12P4	B	Super Precision Bearings
	130	31	6312VV	B6	Single Row Radial Ball Bearings
	130	31	6312Z	B1	Single Row Radial Ball Bearings
	130	31	6312ZNR	B4	Single Row Radial Ball Bearings
	130	31	6312ZZ	B1	Single Row Radial Ball Bearings
	130	31	6312ZZNR	B4	Single Row Radial Ball Bearings
	130	31	7312BEAT85	D	Single Row Angular Contact Ball Bearings
	130	31	7312BEAT85SUN	D	Single Row Angular Contact Ball Bearings
	130	31	7312BW	D	Single Row Angular Contact Ball Bearings
	130	31	7312BWG	D	Single Row Angular Contact Ball Bearings
	130	31	BL312	C	Single Row Radial Ball Bearings
	130	31	BL312NR	C1	Single Row Radial Ball Bearings
	130	31	BL312ZNR	C3	Single Row Radial Ball Bearings
	130	31	N312ET	H	Cylindrical Roller Bearings
	130	31	N312M	H	Cylindrical Roller Bearings
	130	31	N312W	H	Cylindrical Roller Bearings
	130	31	NF312W	H4	Cylindrical Roller Bearings
	130	31	NJ312ET	H1	Cylindrical Roller Bearings
	130	31	NJ312W	H1	Cylindrical Roller Bearings
	130	31	NU312EM	H2	Cylindrical Roller Bearings
	130	31	NU312ET	H2	Cylindrical Roller Bearings

Selection by Dimensions (Metric)

Bore Diameter 60 mm

Bore Diameter	OD	Width	Part Number	Type	Bearing Type
60	130	31	NU312W	H2	Cylindrical Roller Bearings
	130	31	NUP312ET	H3	Cylindrical Roller Bearings
	130	31	NUP312W	H3	Cylindrical Roller Bearings
	130	31	QJ312M	P2	Duplex Ball Bearings
	130	33,5	30312J	F	Tapered Roller Bearings
	130	33,5	31312J	F	Tapered Roller Bearings
	130	42	29412E	O	Spherical Roller Bearings
	130	46	22312CAME4C3VE	K	Spherical Roller Bearings
	130	46	22312CAME4C4VE	K	Spherical Roller Bearings
	130	46	22312EAE4	K	Spherical Roller Bearings
	130	46	22312EAKE4	K1	Spherical Roller Bearings
	130	46	22312EJW33	K	Spherical Roller Bearings
	130	46	22312EKJW33	K1	Spherical Roller Bearings
	130	46	22312EMW33	K	Spherical Roller Bearings
	130	46	22312VEC4	K	Spherical Roller Bearings
	130	46	2312J	G	Double Row Self Aligning Ball Bearings
	130	46	2312KJ	G1	Double Row Self Aligning Ball Bearings
	130	46	4312BTN	L	Double Row Ball Bearings
	130	46	NJ2312W	H1	Cylindrical Roller Bearings
	130	46	NU2312ET	H2	Cylindrical Roller Bearings
	130	46	NU2312M	H2	Cylindrical Roller Bearings
	130	46	NU2312W	H2	Cylindrical Roller Bearings
	130	46	NUP2312W	H3	Cylindrical Roller Bearings
	130	48,5	32312J	F	Tapered Roller Bearings
	130	51	51412	E	Thrust Ball Bearings
	130	54	3312J	M	Double Row Angular Contact Ball Bearings
	130	54	3312B-2RSTN	M2	Double Row Angular Contact Ball Bearings
	130	54	3312B-2ZTN	M1	Double Row Angular Contact Ball Bearings
	130	54	3312BNRTN	M3	Double Row Angular Contact Ball Bearings
	130	54	3312BTN	M	Double Row Angular Contact Ball Bearings
	130	54	3312NRJ	M3	Double Row Angular Contact Ball Bearings
	130	62	7312CTDULP4	D	Super Precision Bearings
	130	62	7312CTDUMP4	D	Super Precision Bearings
	130	62	7312ETDULP4	D	Super Precision Bearings
	130	62	7312ETDUMP4	D	Super Precision Bearings
	135	58	53412	E1	Thrust Ball Bearings
	135	79	52315	N	Thrust Ball Bearings
	140	95	54315	N1	Thrust Ball Bearings
	150	35	6412	B	Single Row Radial Ball Bearings
	150	35	6412ZZ	B1	Single Row Radial Ball Bearings
	150	35	7412BIMG	D	Single Row Angular Contact Ball Bearings
	150	35	N412W	H	Cylindrical Roller Bearings
	150	35	NJ412M	H1	Cylindrical Roller Bearings
	150	35	NJ412W	H1	Cylindrical Roller Bearings
	150	35	NU412M	H2	Cylindrical Roller Bearings
	150	35	NU412W	H2	Cylindrical Roller Bearings
	165	135	54415	N1	Thrust Ball Bearings
	78	10	6812	B	Single Row Radial Ball Bearings
	78	10	6812DD	B2	Single Row Radial Ball Bearings
	78	10	6812VV	B6	Single Row Radial Ball Bearings
	78	10	6812ZZ	B1	Single Row Radial Ball Bearings
	85	13	6912	B	Single Row Radial Ball Bearings
	85	13	6912DDU	B2	Single Row Radial Ball Bearings
	85	13	6912VV	B6	Single Row Radial Ball Bearings
	85	13	6912ZZ	B1	Single Row Radial Ball Bearings
	85	13	7912ASTRV1VSULP3	D	Super Precision Bearings
	85	13	7912ASTRV1VSUMP3	D	Super Precision Bearings
	85	13	7912CTRV1VSULP3	D	Super Precision Bearings
	85	13	7912CTRV1VSUMP3	D	Super Precision Bearings
	85	17	51112	E	Thrust Ball Bearings

Selection by Dimensions (Metric)

Bore Diameter 60 – 65 mm

Bore Diameter	OD	Width	Part Number	Type	Bearing Type
60	85	17	32912J	F	Tapered Roller Bearings
	85	26	7912ASTRDULP3	D	Super Precision Bearings
	85	26	7912ASTRDUMP3	D	Super Precision Bearings
	85	26	7912CTRDULP3	D	Super Precision Bearings
	85	26	7912CTRDUMP3	D	Super Precision Bearings
60	95	11	16012	B	Single Row Radial Ball Bearings
	95	18	6012	B	Single Row Radial Ball Bearings
	95	18	6012DDU	B2	Single Row Radial Ball Bearings
	95	18	6012DDUNR	B5	Single Row Radial Ball Bearings
	95	18	6012DU	B2	Single Row Radial Ball Bearings
	95	18	6012M	B	Single Row Radial Ball Bearings
	95	18	6012NR	B3	Single Row Radial Ball Bearings
	95	18	6012TCG12P4	B	Super Precision Bearings
	95	18	6012TCG12P4	B	Super Precision Bearings
	95	18	6012VV	B6	Single Row Radial Ball Bearings
	95	18	6012Z	B1	Single Row Radial Ball Bearings
	95	18	6012ZNR	B4	Single Row Radial Ball Bearings
	95	18	6012ZZ	B1	Single Row Radial Ball Bearings
	95	18	6012ZZNR	B4	Single Row Radial Ball Bearings
	95	18	7012AM	D	Single Row Angular Contact Ball Bearings
	95	18	7012ASTRV1VSULP3	D	Super Precision Bearings
	95	18	7012ASTRV1VSUMP3	D	Super Precision Bearings
	95	18	7012BM	D	Single Row Angular Contact Ball Bearings
	95	18	7012CTRV1VSULP3	D	Super Precision Bearings
	95	18	7012CTRV1VSUMP3	D	Super Precision Bearings
	95	18	N1012J	H	Cylindrical Roller Bearings
	95	18	NU1012M	H2	Cylindrical Roller Bearings
	95	23	32012XJ	F	Tapered Roller Bearings
	95	26	51212	E	Thrust Ball Bearings
	95	26	NN3012MBKRCC1P4	I	Super Precision Bearings
	95	27	33012J	F	Tapered Roller Bearings
	95	36	7012ASTRDULP3	D	Super Precision Bearings
	95	36	7012ASTRDUMP3	D	Super Precision Bearings
	95	36	7012CTRDULP3	D	Super Precision Bearings
	95	36	7012CTRDUMP3	D	Super Precision Bearings
	95	36	T7012CTDULP3	D	Super Precision Bearings
95	45	RS-5012DSE7NAS5	H6	Cylindrical Roller Bearings	
95	46	NNCF5012V	I2	Cylindrical Roller Bearings	
65	100	11	16013	B	Single Row Radial Ball Bearings
	100	18	6013	B	Single Row Radial Ball Bearings
	100	18	6013DDU	B2	Single Row Radial Ball Bearings
	100	18	6013DDUNR	B5	Single Row Radial Ball Bearings
	100	18	6013DU	B2	Single Row Radial Ball Bearings
	100	18	6013NR	B3	Single Row Radial Ball Bearings
	100	18	6013TCG12P4	B	Super Precision Bearings
	100	18	6013TCG12P4	B	Super Precision Bearings
	100	18	6013VV	B6	Single Row Radial Ball Bearings
	100	18	6013Z	B1	Single Row Radial Ball Bearings
	100	18	6013ZNR	B4	Single Row Radial Ball Bearings
	100	18	6013ZZ	B1	Single Row Radial Ball Bearings
	100	18	6013ZZNR	B4	Single Row Radial Ball Bearings
	100	18	7013ASTRV1VSULP3	D	Super Precision Bearings
	100	18	7013ASTRV1VSUMP3	D	Super Precision Bearings
	100	18	7013CTRV1VSULP3	D	Super Precision Bearings
	100	18	7013CTRV1VSUMP3	D	Super Precision Bearings
	100	18	NU1013M	H2	Cylindrical Roller Bearings
	100	23	32013XJ	F	Tapered Roller Bearings
	100	26	NN3013MBKRCC1P4	I	Super Precision Bearings
	100	27	51213	E	Thrust Ball Bearings
	100	27	33013J	F	Tapered Roller Bearings
	100	36	7013ASTRDULP3	D	Super Precision Bearings

Selection by Dimensions (Metric)

Bore Diameter 65 mm

Bore Diameter	OD	Width	Part Number	Type	Bearing Type
65	100	36	7013ASTRDUMP3	D	Super Precision Bearings
	100	36	7013CTRDULP3	D	Super Precision Bearings
	100	36	7013CTRDUMP3	D	Super Precision Bearings
	100	36	T7013CTDULP3	D	Super Precision Bearings
	100	45	RS-5013DSE7NASS	H6	Cylindrical Roller Bearings
	105	32	53213	E1	Thrust Ball Bearings
	110	34	33113J	F	Tapered Roller Bearings
	115	36	51313	E	Thrust Ball Bearings
	115	48	52216	N	Thrust Ball Bearings
	120	23	1213J	G	Double Row Self Aligning Ball Bearings
	120	23	1213KJ	G1	Double Row Self Aligning Ball Bearings
	120	23	1213KTN	G1	Double Row Self Aligning Ball Bearings
	120	23	6213	B	Single Row Radial Ball Bearings
	120	23	6213DDU	B2	Single Row Radial Ball Bearings
	120	23	6213DU	B2	Single Row Radial Ball Bearings
	120	23	6213M	B	Single Row Radial Ball Bearings
	120	23	6213NR	B3	Single Row Radial Ball Bearings
	120	23	6213TCG12P4	B	Super Precision Bearings
	120	23	6213TCG12P4	B	Super Precision Bearings
	120	23	6213VV	B6	Single Row Radial Ball Bearings
	120	23	6213Z	B1	Single Row Radial Ball Bearings
	120	23	6213ZNR	B4	Single Row Radial Ball Bearings
	120	23	6213ZZ	B1	Single Row Radial Ball Bearings
	120	23	6213ZZNR	B4	Single Row Radial Ball Bearings
	120	23	7213BEAT85	D	Single Row Angular Contact Ball Bearings
	120	23	7213BEAT85SUN	D	Single Row Angular Contact Ball Bearings
	120	23	7213BW	D	Single Row Angular Contact Ball Bearings
	120	23	7213BWG	D	Single Row Angular Contact Ball Bearings
	120	23	BL213	C	Single Row Radial Ball Bearings
	120	23	BL213NR	C1	Single Row Radial Ball Bearings
	120	23	BL213ZNR	C3	Single Row Radial Ball Bearings
	120	23	N213W	H	Cylindrical Roller Bearings
	120	23	NF213W	H4	Cylindrical Roller Bearings
	120	23	NJ213ET	H1	Cylindrical Roller Bearings
	120	23	NJ213EW	H1	Cylindrical Roller Bearings
	120	23	NU213EM	H2	Cylindrical Roller Bearings
	120	23	NU213ET	H2	Cylindrical Roller Bearings
	120	23	NU213EW	H2	Cylindrical Roller Bearings
	120	23	NUP213ET	H3	Cylindrical Roller Bearings
	120	23	NUP213EW	H3	Cylindrical Roller Bearings
	120	24,75	30213J	F	Tapered Roller Bearings
	120	31	2213J	G	Double Row Self Aligning Ball Bearings
	120	31	2213EKTN	G1	Double Row Self Aligning Ball Bearings
	120	31	2213ETN	G	Double Row Self Aligning Ball Bearings
	120	31	2213KJ	G1	Double Row Self Aligning Ball Bearings
	120	31	22213EAE4	K	Spherical Roller Bearings
	120	31	22213EAKE4	K1	Spherical Roller Bearings
	120	31	22213EJW33	K	Spherical Roller Bearings
	120	31	22213EKJW33	K1	Spherical Roller Bearings
	120	31	4213J	L	Double Row Ball Bearings
	120	31	4213BTN	L	Double Row Ball Bearings
	120	31	NJ2213ET	H1	Cylindrical Roller Bearings
	120	31	NJ2213M	H1	Cylindrical Roller Bearings
	120	31	NJ2213W	H1	Cylindrical Roller Bearings
	120	31	NU2213ET	H2	Cylindrical Roller Bearings
	120	31	NU2213W	H2	Cylindrical Roller Bearings
	120	31	NUP2213ET	H3	Cylindrical Roller Bearings
	120	31	NUP2213W	H3	Cylindrical Roller Bearings
	120	32,75	32213J	F	Tapered Roller Bearings
	120	38,1	3213J	M	Double Row Angular Contact Ball Bearings
	120	38,1	3213B-2RSTN	M2	Double Row Angular Contact Ball Bearings

Selection by Dimensions (Metric)

Bore Diameter 65 mm

Bore Diameter	OD	Width	Part Number	Type	Bearing Type
65	120	38,1	3213B-2ZTN	M1	Double Row Angular Contact Ball Bearings
	120	38,1	3213BTN	M	Double Row Angular Contact Ball Bearings
	120	41	33213J	F	Tapered Roller Bearings
	120	43	53313	E1	Thrust Ball Bearings
	120	46	7213A5TRDULP3	D	Super Precision Bearings
	120	46	7213A5TRDUMP3	D	Super Precision Bearings
	120	46	7213CTRULP3	D	Super Precision Bearings
	120	46	7213CTRDUMP3	D	Super Precision Bearings
140	33	1313J	1313J	G	Double Row Self Aligning Ball Bearings
	33	1313KJ	1313KJ	G1	Double Row Self Aligning Ball Bearings
	33	21313EAE4	21313EAE4	K	Spherical Roller Bearings
	33	21313EAKE4	21313EAKE4	K1	Spherical Roller Bearings
	33	21313J	21313J	K	Spherical Roller Bearings
	33	21313KJ	21313KJ	K1	Spherical Roller Bearings
	33	6313	6313	B	Single Row Radial Ball Bearings
	33	6313DDU	6313DDU	B2	Single Row Radial Ball Bearings
	33	6313DU	6313DU	B2	Single Row Radial Ball Bearings
	33	6313M	6313M	B	Single Row Radial Ball Bearings
	33	6313NR	6313NR	B3	Single Row Radial Ball Bearings
	33	6313TBR12P4	6313TBR12P4	B	Super Precision Bearings
	33	6313VV	6313VV	B6	Single Row Radial Ball Bearings
	33	6313Z	6313Z	B1	Single Row Radial Ball Bearings
	33	6313ZNR	6313ZNR	B4	Single Row Radial Ball Bearings
	33	6313ZZ	6313ZZ	B1	Single Row Radial Ball Bearings
	33	6313ZZNR	6313ZZNR	B4	Single Row Radial Ball Bearings
	33	7313BEAT85	7313BEAT85	D	Single Row Angular Contact Ball Bearings
	33	7313BEAT85SUN	7313BEAT85SUN	D	Single Row Angular Contact Ball Bearings
	33	7313BW	7313BW	D	Single Row Angular Contact Ball Bearings
	33	7313BWG	7313BWG	D	Single Row Angular Contact Ball Bearings
	33	BL313	BL313	C	Single Row Radial Ball Bearings
	33	BL313ZNR	BL313ZNR	C3	Single Row Radial Ball Bearings
	33	N313ET	N313ET	H	Cylindrical Roller Bearings
	33	N313M	N313M	H	Cylindrical Roller Bearings
	33	N313W	N313W	H	Cylindrical Roller Bearings
	33	NF313W	NF313W	H4	Cylindrical Roller Bearings
	33	NJ313ET	NJ313ET	H1	Cylindrical Roller Bearings
	33	NJ313W	NJ313W	H1	Cylindrical Roller Bearings
	33	NU313EM	NU313EM	H2	Cylindrical Roller Bearings
	33	NU313ET	NU313ET	H2	Cylindrical Roller Bearings
	33	NU313W	NU313W	H2	Cylindrical Roller Bearings
	33	NUP313ET	NUP313ET	H3	Cylindrical Roller Bearings
	33	NUP313W	NUP313W	H3	Cylindrical Roller Bearings
	36	30313J	30313J	F	Tapered Roller Bearings
	36	31313J	31313J	F	Tapered Roller Bearings
	45	29413E	29413E	O	Spherical Roller Bearings
	48	22313CAME4C4VE	22313CAME4C4VE	K	Spherical Roller Bearings
	48	22313CAME4	22313CAME4	K	Spherical Roller Bearings
	48	22313EAE4	22313EAE4	K	Spherical Roller Bearings
	48	22313EAKE4	22313EAKE4	K1	Spherical Roller Bearings
	48	22313EJW33	22313EJW33	K	Spherical Roller Bearings
	48	22313EKJW33	22313EKJW33	K1	Spherical Roller Bearings
	48	22313VEC4	22313VEC4	K	Spherical Roller Bearings
	48	2313J	2313J	G	Double Row Self Aligning Ball Bearings
	48	2313KJ	2313KJ	G1	Double Row Self Aligning Ball Bearings
	48	2313KTN	2313KTN	G1	Double Row Self Aligning Ball Bearings
	48	4313BTN	4313BTN	L	Double Row Ball Bearings
	48	NJ2313W	NJ2313W	H1	Cylindrical Roller Bearings
	48	NU2313EM	NU2313EM	H2	Cylindrical Roller Bearings
	48	NU2313ET	NU2313ET	H2	Cylindrical Roller Bearings
48	NU2313W	NU2313W	H2	Cylindrical Roller Bearings	
48	NUP2313M	NUP2313M	H3	Cylindrical Roller Bearings	
51	32313J	32313J	F	Tapered Roller Bearings	

Selection by Dimensions (Metric)

Bore Diameter 65 – 70 mm

Bore Diameter	OD	Width	Part Number	Type	Bearing Type	
65	140	56	51413	E	Thrust Ball Bearings	
	140	58,7	3313B-2RSTN	M2	Double Row Angular Contact Ball Bearings	
	140	58,7	3313B-2ZTN	M1	Double Row Angular Contact Ball Bearings	
	140	58,7	3313BNRTN	M3	Double Row Angular Contact Ball Bearings	
	140	58,7	3313BTN	M	Double Row Angular Contact Ball Bearings	
	140	58,7	3313NRJ	M3	Double Row Angular Contact Ball Bearings	
	140	58,7	3313WA	M	Double Row Angular Contact Ball Bearings	
	140	66	7313CTDULP4	D	Super Precision Bearings	
	140	66	7313CTDUMP4	D	Super Precision Bearings	
	140	66	7313ETDULP4	D	Super Precision Bearings	
	140	66	7313ETDUMP4	D	Super Precision Bearings	
	140	79	52316	N	Thrust Ball Bearings	
		145	65	53413	E1	Thrust Ball Bearings
		145	95	54316	N1	Thrust Ball Bearings
	160	37	6413	B	Single Row Radial Ball Bearings	
	160	37	6413NR	B3	Single Row Radial Ball Bearings	
	160	37	7413BMG	D	Single Row Angular Contact Ball Bearings	
	160	37	N413M	H	Cylindrical Roller Bearings	
	160	37	NJ413M	H1	Cylindrical Roller Bearings	
	160	37	NJ413W	H1	Cylindrical Roller Bearings	
	160	37	NU413M	H2	Cylindrical Roller Bearings	
	160	37	NU413W	H2	Cylindrical Roller Bearings	
	85	10	6813	B	Single Row Radial Ball Bearings	
	85	10	6813DD	B2	Single Row Radial Ball Bearings	
	85	10	6813VV	B6	Single Row Radial Ball Bearings	
	85	10	6813ZZ	B1	Single Row Radial Ball Bearings	
	90	13	6913	B	Single Row Radial Ball Bearings	
	90	13	6913DDU	B2	Single Row Radial Ball Bearings	
	90	13	6913VV	B6	Single Row Radial Ball Bearings	
	90	13	6913ZZ	B1	Single Row Radial Ball Bearings	
	90	13	7913ASTRV1VSULP3	D	Super Precision Bearings	
	90	13	7913ASTRV1VSUMP3	D	Super Precision Bearings	
	90	13	7913CTRV1VSULP3	D	Super Precision Bearings	
	90	13	7913CTRV1VSUMP3	D	Super Precision Bearings	
	90	17	32913J	F	Tapered Roller Bearings	
	90	18	51113	E	Thrust Ball Bearings	
	90	26	7913ASTRDULP3	D	Super Precision Bearings	
	90	26	7913ASTRDUMP3	D	Super Precision Bearings	
	90	26	7913CTRDULP3	D	Super Precision Bearings	
	90	26	7913CTRDUMP3	D	Super Precision Bearings	
70	100	16	6914	B	Single Row Radial Ball Bearings	
	100	16	6914VV	B6	Single Row Radial Ball Bearings	
	100	16	6914ZZ	B1	Single Row Radial Ball Bearings	
	100	16	7914ASTRV1VSULP3	D	Super Precision Bearings	
	100	16	7914ASTRV1VSUMP3	D	Super Precision Bearings	
	100	16	7914CTRV1VSULP3	D	Super Precision Bearings	
	100	16	7914CTRV1VSUMP3	D	Super Precision Bearings	
	100	19	NCF2914V	H5	Cylindrical Roller Bearings	
	100	20	32914J	F	Tapered Roller Bearings	
	100	32	7914ASTRDULP3	D	Super Precision Bearings	
	100	32	7914ASTRDUMP3	D	Super Precision Bearings	
	100	32	7914CTRDULP3	D	Super Precision Bearings	
	100	32	7914CTRDUMP3	D	Super Precision Bearings	
		105	27	51214	E	Thrust Ball Bearings
	110	13	16014	B	Single Row Radial Ball Bearings	
	110	20	6014	B	Single Row Radial Ball Bearings	
	110	20	6014DDU	B2	Single Row Radial Ball Bearings	
	110	20	6014DU	B2	Single Row Radial Ball Bearings	
	110	20	6014M	B	Single Row Radial Ball Bearings	

Selection by Dimensions (Metric)

Bore Diameter 70 mm

Bore Diameter	OD	Width	Part Number	Type	Bearing Type	
70	110	20	6014NR	B3	Single Row Radial Ball Bearings	
	110	20	6014TCG12P4	B	Super Precision Bearings	
	110	20	6014TCG12P4	B	Super Precision Bearings	
	110	20	6014VV	B6	Single Row Radial Ball Bearings	
	110	20	6014Z	B1	Single Row Radial Ball Bearings	
	110	20	6014ZNR	B4	Single Row Radial Ball Bearings	
	110	20	6014ZZ	B1	Single Row Radial Ball Bearings	
	110	20	6014ZZNR	B4	Single Row Radial Ball Bearings	
	110	20	7014AM	D	Single Row Angular Contact Ball Bearings	
	110	20	7014ASTRV1VSULP3	D	Super Precision Bearings	
	110	20	7014ASTRV1VSUMP3	D	Super Precision Bearings	
	110	20	7014BM	D	Single Row Angular Contact Ball Bearings	
	110	20	7014CTRV1VSULP3	D	Super Precision Bearings	
	110	20	7014CTRV1VSUMP3	D	Super Precision Bearings	
	110	20	NU1014M	H2	Cylindrical Roller Bearings	
	110	25	32014XJ	F	Tapered Roller Bearings	
	110	30	NN3014MBKRCC1P4	I	Super Precision Bearings	
	110	31	33014J	F	Tapered Roller Bearings	
	110	32	53214	E1	Thrust Ball Bearings	
	110	40	7014ASTRDULP3	D	Super Precision Bearings	
	110	40	7014ASTRDUMP3	D	Super Precision Bearings	
	110	40	7014CTRDULP3	D	Super Precision Bearings	
	110	40	7014CTRDUMP3	D	Super Precision Bearings	
	110	40	T7014CTDULP3	D	Super Precision Bearings	
	110	53	RS-5014DSE7NAS5	H6	Cylindrical Roller Bearings	
		125	24	1214J	G	Double Row Self Aligning Ball Bearings
		125	24	1214KJ	G1	Double Row Self Aligning Ball Bearings
		125	24	6214	B	Single Row Radial Ball Bearings
		125	24	6214DDU	B2	Single Row Radial Ball Bearings
		125	24	6214DU	B2	Single Row Radial Ball Bearings
125		24	6214M	B	Single Row Radial Ball Bearings	
125		24	6214NR	B3	Single Row Radial Ball Bearings	
125		24	6214TCG12P4	B	Super Precision Bearings	
125		24	6214TCG12P4	B	Super Precision Bearings	
125		24	6214VV	B6	Single Row Radial Ball Bearings	
125		24	6214Z	B1	Single Row Radial Ball Bearings	
125		24	6214ZNR	B4	Single Row Radial Ball Bearings	
125		24	6214ZZ	B1	Single Row Radial Ball Bearings	
125		24	7214BEAT85	D	Single Row Angular Contact Ball Bearings	
125		24	7214BEAT85SUN	D	Single Row Angular Contact Ball Bearings	
125		24	7214BW	D	Single Row Angular Contact Ball Bearings	
125		24	7214BWG	D	Single Row Angular Contact Ball Bearings	
125		24	BL214Z	C2	Single Row Radial Ball Bearings	
125		24	N214W	H	Cylindrical Roller Bearings	
125		24	NF214W	H4	Cylindrical Roller Bearings	
125		24	NJ214ET	H1	Cylindrical Roller Bearings	
125		24	NJ214W	H1	Cylindrical Roller Bearings	
125		24	NU214EM	H2	Cylindrical Roller Bearings	
125		24	NU214ET	H2	Cylindrical Roller Bearings	
125		24	NU214W	H2	Cylindrical Roller Bearings	
125		24	NUP214EM	H3	Cylindrical Roller Bearings	
125		24	NUP214ET	H3	Cylindrical Roller Bearings	
125		24	QJ214LOCM	P2	Duplex Ball Bearings	
125		26,25	30214J	F	Tapered Roller Bearings	
125		31	2214J	G	Double Row Self Aligning Ball Bearings	
125		31	2214KJ	G1	Double Row Self Aligning Ball Bearings	
125		31	22214EAE4	K	Spherical Roller Bearings	
125		31	22214EAKE4	K1	Spherical Roller Bearings	
125		31	22214EJW33	K	Spherical Roller Bearings	
125		31	22214EKJW33	K1	Spherical Roller Bearings	
125		31	4214J	L	Double Row Ball Bearings	
125		31	4214BTN	L	Double Row Ball Bearings	

Selection by Dimensions (Metric)

Bore Diameter 70 mm

Bore Diameter	OD	Width	Part Number	Type	Bearing Type	
70	125	31	NJ2214ET	H1	Cylindrical Roller Bearings	
	125	31	NJ2214W	H1	Cylindrical Roller Bearings	
	125	31	NU2214ET	H2	Cylindrical Roller Bearings	
	125	31	NU2214W	H2	Cylindrical Roller Bearings	
	125	31	NUP2214ET	H3	Cylindrical Roller Bearings	
	125	31	NUP2214W	H3	Cylindrical Roller Bearings	
	125	33,25	32214J	F	Tapered Roller Bearings	
	125	39,7	3214B-2RSTN	M2	Double Row Angular Contact Ball Bearings	
	125	39,7	3214B-2ZTN	M1	Double Row Angular Contact Ball Bearings	
	125	39,7	3214BTN	M	Double Row Angular Contact Ball Bearings	
	125	39,7	3214J	M	Double Row Angular Contact Ball Bearings	
	125	40	51314	E	Thrust Ball Bearings	
	125	41	33214J	F	Tapered Roller Bearings	
	125	48	7214ASTRDULP3	D	Super Precision Bearings	
	125	48	7214ASTRDUMP3	D	Super Precision Bearings	
	125	48	7214CTRDULP3	D	Super Precision Bearings	
	125	48	7214CTRDUMP3	D	Super Precision Bearings	
	125	55	52217	N	Thrust Ball Bearings	
		130	48	53314	E1	Thrust Ball Bearings
		150	35	1314J	G	Double Row Self Aligning Ball Bearings
150		35	1314KJ	G1	Double Row Self Aligning Ball Bearings	
150		35	21314EAE4	K	Spherical Roller Bearings	
150		35	21314EAKE4	K1	Spherical Roller Bearings	
150		35	21314J	K	Spherical Roller Bearings	
150		35	21314KJ	K1	Spherical Roller Bearings	
150		35	6314	B	Single Row Radial Ball Bearings	
150		35	6314DDU	B2	Single Row Radial Ball Bearings	
150		35	6314DU	B2	Single Row Radial Ball Bearings	
150		35	6314M	B	Single Row Radial Ball Bearings	
150		35	6314NR	B3	Single Row Radial Ball Bearings	
150		35	6314TBR12P4	B	Super Precision Bearings	
150		35	6314VV	B6	Single Row Radial Ball Bearings	
150		35	6314Z	B1	Single Row Radial Ball Bearings	
150		35	6314ZNR	B4	Single Row Radial Ball Bearings	
150		35	6314ZZ	B1	Single Row Radial Ball Bearings	
150		35	6314ZZNR	B4	Single Row Radial Ball Bearings	
150		35	7314BEAT85	D	Single Row Angular Contact Ball Bearings	
150		35	7314BEAT85SUN	D	Single Row Angular Contact Ball Bearings	
150		35	7314BW	D	Single Row Angular Contact Ball Bearings	
150		35	7314BWG	D	Single Row Angular Contact Ball Bearings	
150		35	BL314	C	Single Row Radial Ball Bearings	
150		35	BL314NR	C1	Single Row Radial Ball Bearings	
150		35	BL314ZNR	C3	Single Row Radial Ball Bearings	
150		35	N314M	H	Cylindrical Roller Bearings	
150		35	N314W	H	Cylindrical Roller Bearings	
150		35	NF314W	H4	Cylindrical Roller Bearings	
150		35	NJ314EM	H1	Cylindrical Roller Bearings	
150		35	NJ314ET	H1	Cylindrical Roller Bearings	
150		35	NJ314W	H1	Cylindrical Roller Bearings	
150		35	NU314EM	H2	Cylindrical Roller Bearings	
150		35	NU314ET	H2	Cylindrical Roller Bearings	
150		35	NU314W	H2	Cylindrical Roller Bearings	
150		35	NUP314ET	H3	Cylindrical Roller Bearings	
150		35	NUP314W	H3	Cylindrical Roller Bearings	
150		38	30314J	F	Tapered Roller Bearings	
150		38	31314J	F	Tapered Roller Bearings	
150		48	29414E	O	Spherical Roller Bearings	
150		51	22314CAME4	K	Spherical Roller Bearings	
150		51	22314CAME4C4VE	K	Spherical Roller Bearings	
150	51	22314EAE4	K	Spherical Roller Bearings		
150	51	22314EAKE4	K1	Spherical Roller Bearings		

Selection by Dimensions (Metric)

Bore Diameter 70 – 75 mm

Bore Diameter	OD	Width	Part Number	Type	Bearing Type
70	150	51	22314EJW33	K	Spherical Roller Bearings
	150	51	22314EKJW33	K1	Spherical Roller Bearings
	150	51	22314KVEC4	K1	Spherical Roller Bearings
	150	51	22314EMW33	K	Spherical Roller Bearings
	150	51	22314VEC4	K	Spherical Roller Bearings
	150	51	2314J	G	Double Row Self Aligning Ball Bearings
	150	51	4314BTN	L	Double Row Ball Bearings
	150	51	NJ2314ET	H1	Cylindrical Roller Bearings
	150	51	NJ2314M	H1	Cylindrical Roller Bearings
	150	51	NJ2314W	H1	Cylindrical Roller Bearings
	150	51	NU2314ET	H2	Cylindrical Roller Bearings
	150	51	NU2314M	H2	Cylindrical Roller Bearings
	150	51	NU2314W	H2	Cylindrical Roller Bearings
	150	51	NUP2314W	H3	Cylindrical Roller Bearings
	150	54	32314J	F	Tapered Roller Bearings
	150	60	51414	E	Thrust Ball Bearings
	150	63,5	3314J	M	Double Row Angular Contact Ball Bearings
	150	70	7314CTDULP4	D	Super Precision Bearings
	150	70	7314ETDULP4	D	Super Precision Bearings
	150	70	7314ETDUMP4	D	Super Precision Bearings
150	87	52317	N	Thrust Ball Bearings	
	155	105	54317	N1	Thrust Ball Bearings
	155	69	53414	E1	Thrust Ball Bearings
	180	42	6414	B	Single Row Radial Ball Bearings
	180	42	7414BMG	D	Single Row Angular Contact Ball Bearings
	180	42	N414M	H	Cylindrical Roller Bearings
	180	42	N414W	H	Cylindrical Roller Bearings
	180	42	NJ414M	H1	Cylindrical Roller Bearings
	180	42	NJ414W	H1	Cylindrical Roller Bearings
	180	42	NU414M	H2	Cylindrical Roller Bearings
	180	42	NU414W	H2	Cylindrical Roller Bearings
	180	79,38	HDJK70M	P1	Double Row Angular Contact Ball Bearings
	195	157	54418	N1	Thrust Ball Bearings
	90	10	6814	B	Single Row Radial Ball Bearings
	90	10	6814DD	B2	Single Row Radial Ball Bearings
	90	10	6814VV	B6	Single Row Radial Ball Bearings
	90	10	6814ZZ	B1	Single Row Radial Ball Bearings
	95	18	51114	E	Thrust Ball Bearings
75	100	19	51115	E	Thrust Ball Bearings
	105	16	6915	B	Single Row Radial Ball Bearings
	105	16	6915VV	B6	Single Row Radial Ball Bearings
	105	16	6915ZZ	B1	Single Row Radial Ball Bearings
	105	16	7915ASTRV1VSULP3	D	Super Precision Bearings
	105	16	7915ASTRV1VSUMP3	D	Super Precision Bearings
	105	16	7915CTRV1VSULP3	D	Super Precision Bearings
	105	16	7915CTRV1VSUMP3	D	Super Precision Bearings
	105	20	32915J	F	Tapered Roller Bearings
	105	32	7915ASTRDULP3	D	Super Precision Bearings
	105	32	7915ASTRDUMP3	D	Super Precision Bearings
	105	32	7915CTRDULP3	D	Super Precision Bearings
	105	32	7915CTRDUMP3	D	Super Precision Bearings
		110	27	51215	E
110		30	BSB075110DUHP3	D	Super Precision Bearings
	115	13	16015	B	Single Row Radial Ball Bearings
	115	20	6015	B	Single Row Radial Ball Bearings
	115	20	6015DDU	B2	Single Row Radial Ball Bearings
	115	20	6015DU	B2	Single Row Radial Ball Bearings
	115	20	6015M	B	Single Row Radial Ball Bearings

Selection by Dimensions (Metric)

Bore Diameter 75 mm

Bore Diameter	OD	Width	Part Number	Type	Bearing Type
75	115	20	6015NR	B3	Single Row Radial Ball Bearings
	115	20	6015VV	B6	Single Row Radial Ball Bearings
	115	20	6015Z	B1	Single Row Radial Ball Bearings
	115	20	6015ZNR	B4	Single Row Radial Ball Bearings
	115	20	6015ZZ	B1	Single Row Radial Ball Bearings
	115	20	7015ASTRV1VSULP3	D	Super Precision Bearings
	115	20	7015ASTRV1VSUMP3	D	Super Precision Bearings
	115	20	7015CTRV1VSULP3	D	Super Precision Bearings
	115	20	7015CTRV1VSUMP3	D	Super Precision Bearings
	115	20	NU1015M	H2	Cylindrical Roller Bearings
	115	25	32015XJ	F	Tapered Roller Bearings
	115	30	NN3015MBKRCC1P4	I	Super Precision Bearings
	115	31	33015J	F	Tapered Roller Bearings
	115	32	53215	E1	Thrust Ball Bearings
	115	40	7015ASTRDULP3	D	Super Precision Bearings
	115	40	7015ASTRDUMP3	D	Super Precision Bearings
	115	40	7015CTRDULP3	D	Super Precision Bearings
	115	40	7015CTRDUMP3	D	Super Precision Bearings
	115	40	T7015CTDULP3	D	Super Precision Bearings
	115	53	RS-5015DSE7NAS5	H6	Cylindrical Roller Bearings
115	54	NNCF5015V	I2	Cylindrical Roller Bearings	
	125	37	33115J	F	Tapered Roller Bearings
	130	25	1215J	G	Double Row Self Aligning Ball Bearings
	130	25	1215KJ	G1	Double Row Self Aligning Ball Bearings
	130	25	6215	B	Single Row Radial Ball Bearings
	130	25	6215DDU	B2	Single Row Radial Ball Bearings
	130	25	6215DU	B2	Single Row Radial Ball Bearings
	130	25	6215M	B	Single Row Radial Ball Bearings
	130	25	6215NR	B3	Single Row Radial Ball Bearings
	130	25	6215TCG12P4	B	Super Precision Bearings
	130	25	6215TCG12P4	B	Super Precision Bearings
	130	25	6215VV	B6	Single Row Radial Ball Bearings
	130	25	6215Z	B1	Single Row Radial Ball Bearings
	130	25	6215ZNR	B4	Single Row Radial Ball Bearings
	130	25	6215ZZ	B1	Single Row Radial Ball Bearings
	130	25	7215BEAT85	D	Single Row Angular Contact Ball Bearings
	130	25	7215BEAT85SUN	D	Single Row Angular Contact Ball Bearings
	130	25	7215BW	D	Single Row Angular Contact Ball Bearings
	130	25	7215BWG	D	Single Row Angular Contact Ball Bearings
	130	25	BL215	C	Single Row Radial Ball Bearings
	130	25	N215W	H	Cylindrical Roller Bearings
	130	25	NF215W	H4	Cylindrical Roller Bearings
	130	25	NJ215ET	H1	Cylindrical Roller Bearings
	130	25	NJ215W	H1	Cylindrical Roller Bearings
	130	25	NU215EM	H2	Cylindrical Roller Bearings
	130	25	NU215ET	H2	Cylindrical Roller Bearings
	130	25	NU215W	H2	Cylindrical Roller Bearings
	130	25	NUP215ET	H3	Cylindrical Roller Bearings
	130	25	NUP215W	H3	Cylindrical Roller Bearings
	130	27,25	30215J	F	Tapered Roller Bearings
	130	31	2215J	G	Double Row Self Aligning Ball Bearings
	130	31	2215KJ	G1	Double Row Self Aligning Ball Bearings
	130	31	22215EAE4	K	Spherical Roller Bearings
	130	31	22215EAKE4	K1	Spherical Roller Bearings
	130	31	22215EJW33	K	Spherical Roller Bearings
	130	31	22215EKJW33	K1	Spherical Roller Bearings
	130	31	4215J	L	Double Row Ball Bearings
	130	31	4215BTN	L	Double Row Ball Bearings
	130	31	NJ2215ET	H1	Cylindrical Roller Bearings
	130	31	NJ2215W	H1	Cylindrical Roller Bearings
	130	31	NU2215ET	H2	Cylindrical Roller Bearings

Selection by Dimensions (Metric)

Bore Diameter 75 mm

Bore Diameter	OD	Width	Part Number	Type	Bearing Type
75	130	31	NU2215M	H2	Cylindrical Roller Bearings
	130	31	NU2215W	H2	Cylindrical Roller Bearings
	130	31	NUP2215ET	H3	Cylindrical Roller Bearings
	130	33,25	32215J	F	Tapered Roller Bearings
	130	41	33215J	F	Tapered Roller Bearings
	130	50	7215ASTRDULP3	D	Super Precision Bearings
	130	50	7215ASTRDUMP3	D	Super Precision Bearings
	130	50	7215CTRDULP3	D	Super Precision Bearings
	130	50	7215CTRDUMP3	D	Super Precision Bearings
	135	44	51315	E	Thrust Ball Bearings
	135	62	52218	N	Thrust Ball Bearings
	140	52	53315	E1	Thrust Ball Bearings
	155	88	52318	N	Thrust Ball Bearings
	160	106	54318	N1	Thrust Ball Bearings
	160	37	1315J	G	Double Row Self Aligning Ball Bearings
	160	37	1315KJ	G1	Double Row Self Aligning Ball Bearings
	160	37	21315EAE4	K	Spherical Roller Bearings
	160	37	21315EAKE4	K1	Spherical Roller Bearings
	160	37	21315J	K	Spherical Roller Bearings
	160	37	21315KJ	K1	Spherical Roller Bearings
	160	37	6315	B	Single Row Radial Ball Bearings
	160	37	6315DDU	B2	Single Row Radial Ball Bearings
	160	37	6315DU	B2	Single Row Radial Ball Bearings
	160	37	6315M	B	Single Row Radial Ball Bearings
	160	37	6315NR	B3	Single Row Radial Ball Bearings
	160	37	6315TBR12P4	B	Super Precision Bearings
	160	37	6315VV	B6	Single Row Radial Ball Bearings
	160	37	6315Z	B1	Single Row Radial Ball Bearings
	160	37	6315ZZ	B1	Single Row Radial Ball Bearings
	160	37	7315BEAT85	D	Single Row Angular Contact Ball Bearings
	160	37	7315BEAT85SUN	D	Single Row Angular Contact Ball Bearings
	160	37	7315BW	D	Single Row Angular Contact Ball Bearings
	160	37	7315BWG	D	Single Row Angular Contact Ball Bearings
	160	37	N315ET	H	Cylindrical Roller Bearings
	160	37	N315M	H	Cylindrical Roller Bearings
	160	37	N315W	H	Cylindrical Roller Bearings
	160	37	NF315W	H4	Cylindrical Roller Bearings
	160	37	NJ315ET	H1	Cylindrical Roller Bearings
	160	37	NJ315W	H1	Cylindrical Roller Bearings
	160	37	NU315EM	H2	Cylindrical Roller Bearings
	160	37	NU315ET	H2	Cylindrical Roller Bearings
	160	37	NU315W	H2	Cylindrical Roller Bearings
	160	37	NUP315ET	H3	Cylindrical Roller Bearings
	160	37	NUP315W	H3	Cylindrical Roller Bearings
	160	40	30315J	F	Tapered Roller Bearings
	160	40	31315J	F	Tapered Roller Bearings
	160	51	29415E	O	Spherical Roller Bearings
	160	55	22315CAME4	K	Spherical Roller Bearings
	160	55	22315CAME4C4VE	K	Spherical Roller Bearings
	160	55	22315EAE4	K	Spherical Roller Bearings
	160	55	22315EAKE4	K1	Spherical Roller Bearings
	160	55	22315EJW33	K	Spherical Roller Bearings
	160	55	22315EKJW33	K1	Spherical Roller Bearings
	160	55	22315EMW33	K	Spherical Roller Bearings
	160	55	22315VEC4	K	Spherical Roller Bearings
160	55	2315J	G	Double Row Self Aligning Ball Bearings	
160	55	2315KJ	G1	Double Row Self Aligning Ball Bearings	
160	55	4315BTN	L	Double Row Ball Bearings	
160	55	NJ2315W	H1	Cylindrical Roller Bearings	
160	55	NU2315ET	H2	Cylindrical Roller Bearings	

Selection by Dimensions (Metric)

Bore Diameter 75 – 80 mm

Bore Diameter	OD	Width	Part Number	Type	Bearing Type
75	160	55	NU2315M	H2	Cylindrical Roller Bearings
	160	55	NU2315W	H2	Cylindrical Roller Bearings
	160	55	NUP2315ET	H3	Cylindrical Roller Bearings
	160	58	32315J	F	Tapered Roller Bearings
	160	65	51415	E	Thrust Ball Bearings
	165	75	53415	E1	Thrust Ball Bearings
	190	45	6415	B	Single Row Radial Ball Bearings
	190	45	7415BMG	D	Single Row Angular Contact Ball Bearings
	190	45	NJ415W	H1	Cylindrical Roller Bearings
	190	45	NU415W	H2	Cylindrical Roller Bearings
	190	82,55	HDJK75M	P1	Double Row Angular Contact Ball Bearings
	95	10	6815	B	Single Row Radial Ball Bearings
	95	10	6815VV	B6	Single Row Radial Ball Bearings
	95	10	6815ZZ	B1	Single Row Radial Ball Bearings
80	100	10	6816	B	Single Row Radial Ball Bearings
	100	10	6816VV	B6	Single Row Radial Ball Bearings
	100	10	6816ZZ	B1	Single Row Radial Ball Bearings
	105	19	51116	E	Thrust Ball Bearings
	110	16	6916	B	Single Row Radial Ball Bearings
	110	16	6916DDU	B2	Single Row Radial Ball Bearings
	110	16	6916VV	B6	Single Row Radial Ball Bearings
	110	16	6916ZZ	B1	Single Row Radial Ball Bearings
	110	16	7916ASTRV1VSULP3	D	Super Precision Bearings
	110	16	7916ASTRV1VSUMP3	D	Super Precision Bearings
	110	16	7916CTRV1VSULP3	D	Super Precision Bearings
	110	16	7916CTRV1VSUMP3	D	Super Precision Bearings
	110	19	NCF2916V	H5	Cylindrical Roller Bearings
	110	20	32916J	F	Tapered Roller Bearings
	110	32	7916ASTRDULP3	D	Super Precision Bearings
	110	32	7916ASTRDUMP3	D	Super Precision Bearings
	110	32	7916CTRDULP3	D	Super Precision Bearings
	110	32	7916CTRDUMP3	D	Super Precision Bearings
	115	28	51216	E	Thrust Ball Bearings
	120	33	53216	E1	Thrust Ball Bearings
	125	14	16016	B	Single Row Radial Ball Bearings
	125	22	6016	B	Single Row Radial Ball Bearings
	125	22	6016DDU	B2	Single Row Radial Ball Bearings
	125	22	6016DU	B2	Single Row Radial Ball Bearings
	125	22	6016NR	B3	Single Row Radial Ball Bearings
	125	22	6016Z	B1	Single Row Radial Ball Bearings
	125	22	6016ZZ	B1	Single Row Radial Ball Bearings
	125	22	7016ASTRV1VSULP3	D	Super Precision Bearings
	125	22	7016ASTRV1VSUMP3	D	Super Precision Bearings
	125	22	7016CTRV1VSULP3	D	Super Precision Bearings
	125	22	7016CTRV1VSUMP3	D	Super Precision Bearings
	125	22	NU1016M	H2	Cylindrical Roller Bearings
	125	29	32016XJ	F	Tapered Roller Bearings
	125	34	NN3016MBKRE1CC1P4	I	Super Precision Bearings
	125	44	7016ASTRDULP3	D	Super Precision Bearings
	125	44	7016ASTRDUMP3	D	Super Precision Bearings
	125	44	7016CTRDULP3	D	Super Precision Bearings
	125	44	7016CTRDUMP3	D	Super Precision Bearings
	125	44	T7016CTDULP3	D	Super Precision Bearings
	125	59	RS-5016DSE7NAS5	H6	Cylindrical Roller Bearings
	130	37	33116J	F	Tapered Roller Bearings
	140	26	1216J	G	Double Row Self Aligning Ball Bearings
	140	26	1216KJ	G1	Double Row Self Aligning Ball Bearings

Selection by Dimensions (Metric)

Bore Diameter 80 mm

Bore Diameter	OD	Width	Part Number	Type	Bearing Type
80	140	26	6216	B	Single Row Radial Ball Bearings
	140	26	6216DDU	B2	Single Row Radial Ball Bearings
	140	26	6216DDUNR	B5	Single Row Radial Ball Bearings
	140	26	6216M	B	Single Row Radial Ball Bearings
	140	26	6216NR	B3	Single Row Radial Ball Bearings
	140	26	6216TCG12P4	B	Super Precision Bearings
	140	26	6216TCG12P4	B	Super Precision Bearings
	140	26	6216VV	B6	Single Row Radial Ball Bearings
	140	26	6216Z	B1	Single Row Radial Ball Bearings
	140	26	6216ZNR	B4	Single Row Radial Ball Bearings
	140	26	6216ZZ	B1	Single Row Radial Ball Bearings
	140	26	7216BEAT85	D	Single Row Angular Contact Ball Bearings
	140	26	7216BEAT85SUN	D	Single Row Angular Contact Ball Bearings
	140	26	7216BW	D	Single Row Angular Contact Ball Bearings
	140	26	7216BWG	D	Single Row Angular Contact Ball Bearings
	140	26	BL216	C	Single Row Radial Ball Bearings
	140	26	BL216Z	C2	Single Row Radial Ball Bearings
	140	26	BL216ZNR	C3	Single Row Radial Ball Bearings
	140	26	BL216ZZ	C2	Single Row Radial Ball Bearings
	140	26	N216ET	H	Cylindrical Roller Bearings
	140	26	N216M	H	Cylindrical Roller Bearings
	140	26	N216W	H	Cylindrical Roller Bearings
	140	26	NF216W	H4	Cylindrical Roller Bearings
	140	26	NJ216ET	H1	Cylindrical Roller Bearings
	140	26	NJ216W	H1	Cylindrical Roller Bearings
	140	26	NU216EM	H2	Cylindrical Roller Bearings
	140	26	NU216ET	H2	Cylindrical Roller Bearings
	140	26	NU216W	H2	Cylindrical Roller Bearings
	140	26	NUP216ET	H3	Cylindrical Roller Bearings
	140	26	NUP216W	H3	Cylindrical Roller Bearings
	140	28,25	30216J	F	Tapered Roller Bearings
	140	33	2216J	G	Double Row Self Aligning Ball Bearings
	140	33	2216KJ	G1	Double Row Self Aligning Ball Bearings
	140	33	22216EAE4	K	Spherical Roller Bearings
	140	33	22216EAKE4	K1	Spherical Roller Bearings
	140	33	22216EJW33	K	Spherical Roller Bearings
	140	33	22216EKJW33	K1	Spherical Roller Bearings
	140	33	4216BTN	L	Double Row Ball Bearings
	140	33	NJ2216ET	H1	Cylindrical Roller Bearings
	140	33	NJ2216W	H1	Cylindrical Roller Bearings
	140	33	NU2216ET	H2	Cylindrical Roller Bearings
	140	33	NU2216M	H2	Cylindrical Roller Bearings
	140	33	NU2216W	H2	Cylindrical Roller Bearings
	140	33	NUP2216ET	H3	Cylindrical Roller Bearings
	140	33	NUP2216M	H3	Cylindrical Roller Bearings
	140	35,25	32216J	F	Tapered Roller Bearings
	140	44	51316	E	Thrust Ball Bearings
	140	44,45	LDJK80M	P1	Double Row Angular Contact Ball Bearings
	140	46	33216J	F	Tapered Roller Bearings
	140	52	7216ASTRDULP3	D	Super Precision Bearings
	140	52	7216ASTRDUMP3	D	Super Precision Bearings
	140	52	7216CTRDULP3	D	Super Precision Bearings
	140	52	7216CTRDUMP3	D	Super Precision Bearings
	145	52	53316	E1	Thrust Ball Bearings
	170	39	1316J	G	Double Row Self Aligning Ball Bearings
	170	39	1316KJ	G1	Double Row Self Aligning Ball Bearings
	170	39	21316EAE4	K	Spherical Roller Bearings
	170	39	21316EAKE4	K1	Spherical Roller Bearings
	170	39	21316J	K	Spherical Roller Bearings
	170	39	21316KJ	K1	Spherical Roller Bearings
	170	39	6316	B	Single Row Radial Ball Bearings

Selection by Dimensions (Metric)

Bore Diameter 80 – 85 mm

Bore Diameter	OD	Width	Part Number	Type	Bearing Type	
80	170	39	6316DDU	B2	Single Row Radial Ball Bearings	
	170	39	6316DU	B2	Single Row Radial Ball Bearings	
	170	39	6316M	B	Single Row Radial Ball Bearings	
	170	39	6316NR	B3	Single Row Radial Ball Bearings	
	170	39	6316TBR12P4	B	Super Precision Bearings	
	170	39	6316VV	B6	Single Row Radial Ball Bearings	
	170	39	6316Z	B1	Single Row Radial Ball Bearings	
	170	39	6316ZZ	B1	Single Row Radial Ball Bearings	
	170	39	7316BEAT85	D	Single Row Angular Contact Ball Bearings	
	170	39	7316BEAT85SUN	D	Single Row Angular Contact Ball Bearings	
	170	39	7316BW	D	Single Row Angular Contact Ball Bearings	
	170	39	7316BWG	D	Single Row Angular Contact Ball Bearings	
	170	39	N316M	H	Cylindrical Roller Bearings	
	170	39	N316W	H	Cylindrical Roller Bearings	
	170	39	NF316W	H4	Cylindrical Roller Bearings	
	170	39	NJ316EM	H1	Cylindrical Roller Bearings	
	170	39	NJ316ET	H1	Cylindrical Roller Bearings	
	170	39	NJ316W	H1	Cylindrical Roller Bearings	
	170	39	NU316EM	H2	Cylindrical Roller Bearings	
	170	39	NU316ET	H2	Cylindrical Roller Bearings	
	170	39	NU316W	H2	Cylindrical Roller Bearings	
	170	39	NUP316ET	H3	Cylindrical Roller Bearings	
	170	42,5	30316J	F	Tapered Roller Bearings	
	170	42,5	31316J	F	Tapered Roller Bearings	
	170	54	29416E	O	Spherical Roller Bearings	
	170	58	22316CAME4C4VE	K	Spherical Roller Bearings	
	170	58	22316EAE4	K	Spherical Roller Bearings	
	170	58	22316EAKE4	K1	Spherical Roller Bearings	
	170	58	22316EJW33	K	Spherical Roller Bearings	
	170	58	22316EKJW33	K1	Spherical Roller Bearings	
	170	58	22316EKMW33	K1	Spherical Roller Bearings	
	170	58	22316KVEC4	K1	Spherical Roller Bearings	
	170	58	22316EMW33	K	Spherical Roller Bearings	
	170	58	22316VEC4	K	Spherical Roller Bearings	
	170	58	2316J	G	Double Row Self Aligning Ball Bearings	
	170	58	2316KJ	G1	Double Row Self Aligning Ball Bearings	
	170	58	NJ2316M	H1	Cylindrical Roller Bearings	
	170	58	NJ2316W	H1	Cylindrical Roller Bearings	
	170	58	NU2316ET	H2	Cylindrical Roller Bearings	
	170	58	NU2316M	H2	Cylindrical Roller Bearings	
	170	58	NU2316W	H2	Cylindrical Roller Bearings	
	170	61,5	32316J	F	Tapered Roller Bearings	
	170	68	51416	E	Thrust Ball Bearings	
	170	68,26	MDJK80M	P1	Double Row Angular Contact Ball Bearings	
	170	68,3	3316M	M	Double Row Angular Contact Ball Bearings	
		175	78	53416	E1	Thrust Ball Bearings
		200	48	6416	B	Single Row Radial Ball Bearings
		200	48	NJ416M	H1	Cylindrical Roller Bearings
		200	48	NJ416W	H1	Cylindrical Roller Bearings
		200	48	NU416W	H2	Cylindrical Roller Bearings
85	110	13	6817	B	Single Row Radial Ball Bearings	
	110	13	6817VV	B6	Single Row Radial Ball Bearings	
	110	13	6817ZZ	B1	Single Row Radial Ball Bearings	
	110	19	51117	E	Thrust Ball Bearings	
	120	18	6917	B	Single Row Radial Ball Bearings	
	120	18	6917ZZ	B1	Single Row Radial Ball Bearings	
	120	18	7917ASTRV1VSULP3	D	Super Precision Bearings	
	120	18	7917ASTRV1VSUMP3	D	Super Precision Bearings	
	120	18	7917VTRV1VSULP3	D	Super Precision Bearings	
	120	18	7917CTRV1VSUMP3	D	Super Precision Bearings	

Selection by Dimensions (Metric)

Bore Diameter 85 mm

Bore Diameter	OD	Width	Part Number	Type	Bearing Type
85	120	23	32917J	F	Tapered Roller Bearings
	120	36	7917ASTRDULP3	D	Super Precision Bearings
	120	36	7917ASTRDUMP3	D	Super Precision Bearings
	120	36	7917CTRDULP3	D	Super Precision Bearings
	120	36	7917CTRDUMP3	D	Super Precision Bearings
	125	31	51217	E	Thrust Ball Bearings
	130	14	16017	B	Single Row Radial Ball Bearings
	130	22	6017	B	Single Row Radial Ball Bearings
	130	22	6017DDU	B2	Single Row Radial Ball Bearings
	130	22	6017NR	B3	Single Row Radial Ball Bearings
	130	22	6017TCG12P4	B	Super Precision Bearings
	130	22	6017TCG12P4	B	Super Precision Bearings
	130	22	6017VV	B6	Single Row Radial Ball Bearings
	130	22	6017Z	B1	Single Row Radial Ball Bearings
	130	22	6017ZNR	B4	Single Row Radial Ball Bearings
	130	22	6017ZZ	B1	Single Row Radial Ball Bearings
	130	22	7017ASTRV1VSULP3	D	Super Precision Bearings
	130	22	7017ASTRV1VSUMP3	D	Super Precision Bearings
	130	22	7017CTRV1VSULP3	D	Super Precision Bearings
	130	22	7017CTRV1VSUMP3	D	Super Precision Bearings
	130	22	NU1017M	H2	Cylindrical Roller Bearings
	130	29	32017XJ	F	Tapered Roller Bearings
	130	34	NN3017MBKRCC1P4	I	Super Precision Bearings
	130	37	53217	E1	Thrust Ball Bearings
	130	44	7017ASTRDULP3	D	Super Precision Bearings
	130	44	7017ASTRDUMP3	D	Super Precision Bearings
	130	44	7017CTRDULP3	D	Super Precision Bearings
	130	44	7017CTRDUMP3	D	Super Precision Bearings
	130	44	T7017CTDULP3	D	Super Precision Bearings
	130	59	RS-5017DSE7NAS5	H6	Cylindrical Roller Bearings
	140	41	33117J	F	Tapered Roller Bearings
	150	28	1217J	G	Double Row Self Aligning Ball Bearings
	150	28	1217KJ	G1	Double Row Self Aligning Ball Bearings
	150	28	6217	B	Single Row Radial Ball Bearings
	150	28	6217DDU	B2	Single Row Radial Ball Bearings
	150	28	6217DU	B2	Single Row Radial Ball Bearings
	150	28	6217NR	B3	Single Row Radial Ball Bearings
	150	28	6217TCG12P4	B	Super Precision Bearings
	150	28	6217TCG12P4	B	Super Precision Bearings
	150	28	6217Z	B1	Single Row Radial Ball Bearings
	150	28	6217ZNR	B4	Single Row Radial Ball Bearings
	150	28	6217ZZ	B1	Single Row Radial Ball Bearings
	150	28	7217BW	D	Single Row Angular Contact Ball Bearings
	150	28	7217BWG	D	Single Row Angular Contact Ball Bearings
	150	28	N217ET	H	Cylindrical Roller Bearings
	150	28	N217W	H	Cylindrical Roller Bearings
	150	28	NF217W	H4	Cylindrical Roller Bearings
	150	28	NJ217ET	H1	Cylindrical Roller Bearings
	150	28	NJ217W	H1	Cylindrical Roller Bearings
	150	28	NU217ET	H2	Cylindrical Roller Bearings
	150	28	NU217W	H2	Cylindrical Roller Bearings
	150	28	NUP217EM	H3	Cylindrical Roller Bearings
	150	28	NUP217ET	H3	Cylindrical Roller Bearings
	150	30,5	30217J	F	Tapered Roller Bearings
	150	36	2217J	G	Double Row Self Aligning Ball Bearings
	150	36	2217KJ	G1	Double Row Self Aligning Ball Bearings
	150	36	22217EAE4	K	Spherical Roller Bearings
	150	36	22217EAKE4	K1	Spherical Roller Bearings
	150	36	22217EJW33	K	Spherical Roller Bearings
	150	36	22217EKJW33	K1	Spherical Roller Bearings

Selection by Dimensions (Metric)

Bore Diameter 85 mm

Bore Diameter	OD	Width	Part Number	Type	Bearing Type
85	150	36	4217BTN	L	Double Row Ball Bearings
	150	36	NJ2217ET	H1	Cylindrical Roller Bearings
	150	36	NJ2217W	H1	Cylindrical Roller Bearings
	150	36	NU2217ET	H2	Cylindrical Roller Bearings
	150	36	NU2217M	H2	Cylindrical Roller Bearings
	150	36	NU2217W	H2	Cylindrical Roller Bearings
	150	36	NUP2217ET	H3	Cylindrical Roller Bearings
	150	36	NUP2217M	H3	Cylindrical Roller Bearings
	150	38,5	32217J	F	Tapered Roller Bearings
	150	39	29317E	K	Spherical Roller Bearings
	150	49	51317	E	Thrust Ball Bearings
	150	49	33217J	F	Tapered Roller Bearings
	150	56	7217ASTRDULP3	D	Super Precision Bearings
	150	56	7217ASTRDUMP3	D	Super Precision Bearings
	150	56	7217CTRDULP3	D	Super Precision Bearings
	150	56	7217CTRDUMP3	D	Super Precision Bearings
	150	67	52220	N	Thrust Ball Bearings
		155	58	53317	E1
	170	97	52320	N	Thrust Ball Bearings
180	180	41	1317J	G	Double Row Self Aligning Ball Bearings
	180	41	1317KJ	G1	Double Row Self Aligning Ball Bearings
	180	41	21317EAE4	K	Spherical Roller Bearings
	180	41	21317EAKE4	K1	Spherical Roller Bearings
	180	41	21317KM	K1	Spherical Roller Bearings
	180	41	21317M	K	Spherical Roller Bearings
	180	41	6317	B	Single Row Radial Ball Bearings
	180	41	6317DDU	B2	Single Row Radial Ball Bearings
	180	41	6317NR	B3	Single Row Radial Ball Bearings
	180	41	6317TBR12P4	B	Super Precision Bearings
	180	41	6317Z	B1	Single Row Radial Ball Bearings
	180	41	6317ZZ	B1	Single Row Radial Ball Bearings
	180	41	7317BW	D	Single Row Angular Contact Ball Bearings
	180	41	7317BWG	D	Single Row Angular Contact Ball Bearings
	180	41	N317M	H	Cylindrical Roller Bearings
	180	41	N317W	H	Cylindrical Roller Bearings
	180	41	NF317M	H4	Cylindrical Roller Bearings
	180	41	NJ317ET	H1	Cylindrical Roller Bearings
	180	41	NJ317W	H1	Cylindrical Roller Bearings
	180	41	NU317EM	H2	Cylindrical Roller Bearings
	180	41	NU317ET	H2	Cylindrical Roller Bearings
	180	41	NU317W	H2	Cylindrical Roller Bearings
	180	41	NUP317W	H3	Cylindrical Roller Bearings
	180	44,5	30317J	F	Tapered Roller Bearings
	180	44,5	31317J	F	Tapered Roller Bearings
	180	58	29417E	O	Spherical Roller Bearings
	180	60	22317CAME4C4VE	K	Spherical Roller Bearings
	180	60	22317EAE4	K	Spherical Roller Bearings
	180	60	22317EAKE4	K1	Spherical Roller Bearings
	180	60	22317EJW33	K	Spherical Roller Bearings
	180	60	22317EKJW33	K1	Spherical Roller Bearings
	180	60	22317VEC4	K	Spherical Roller Bearings
	180	60	2317J	G	Double Row Self Aligning Ball Bearings
	180	60	2317KJ	G1	Double Row Self Aligning Ball Bearings
	180	60	NJ2317W	H1	Cylindrical Roller Bearings
	180	60	NU2317M	H2	Cylindrical Roller Bearings
	180	60	NU2317W	H2	Cylindrical Roller Bearings
	180	60	NUP2317M	H3	Cylindrical Roller Bearings
	180	63,5	32317J	F	Tapered Roller Bearings
	180	72	51417	E	Thrust Ball Bearings
	180	73,03	MDJK85M	P1	Double Row Angular Contact Ball Bearings
180	73,03	MDJT85M	P	Double Row Angular Contact Ball Bearings	

Selection by Dimensions (Metric)

Bore Diameter 85 – 90 mm

Bore Diameter	OD	Width	Part Number	Type	Bearing Type
85	210	52	6417	B	Single Row Radial Ball Bearings
	210	52	NJ417M	H1	Cylindrical Roller Bearings
	210	52	NU417M	H2	Cylindrical Roller Bearings
90	115	13	6818	B	Single Row Radial Ball Bearings
	115	13	6818VV	B6	Single Row Radial Ball Bearings
	115	13	6818ZZ	B1	Single Row Radial Ball Bearings
	120	22	51118	E	Thrust Ball Bearings
	125	18	6918	B	Single Row Radial Ball Bearings
	125	18	6918VV	B6	Single Row Radial Ball Bearings
	125	18	6918ZZ	B1	Single Row Radial Ball Bearings
	125	18	7918ASTRV1VSULP3	D	Super Precision Bearings
	125	18	7918ASTRV1VSUMP3	D	Super Precision Bearings
	125	18	7918CTRV1VSULP3	D	Super Precision Bearings
	125	18	7918CTRV1VSUMP3	D	Super Precision Bearings
	125	22	NCF2918V	H5	Cylindrical Roller Bearings
	125	23	32918J	F	Tapered Roller Bearings
	125	36	7918ASTRDULP3	D	Super Precision Bearings
	125	36	7918ASTRDUMP3	D	Super Precision Bearings
	125	36	7918CTRDULP3	D	Super Precision Bearings
	125	36	7918CTRDUMP3	D	Super Precision Bearings
	125	36	7918CTRDUMP3	D	Super Precision Bearings
	135	35	51218	E	Thrust Ball Bearings
	140	16	16018	B	Single Row Radial Ball Bearings
	140	24	6018	B	Single Row Radial Ball Bearings
	140	24	6018DDU	B2	Single Row Radial Ball Bearings
	140	24	6018DU	B2	Single Row Radial Ball Bearings
	140	24	6018NR	B3	Single Row Radial Ball Bearings
	140	24	6018TCG12P4	B	Super Precision Bearings
	140	24	6018TCG12P4	B	Super Precision Bearings
	140	24	6018VV	B6	Single Row Radial Ball Bearings
	140	24	6018Z	B1	Single Row Radial Ball Bearings
	140	24	6018ZNR	B4	Single Row Radial Ball Bearings
	140	24	6018ZZ	B1	Single Row Radial Ball Bearings
	140	24	7018ASTRV1VSULP3	D	Super Precision Bearings
	140	24	7018CTRV1VSUEL3	D	Super Precision Bearings
	140	24	NU1018M	H2	Cylindrical Roller Bearings
	140	32	32018XJ	F	Tapered Roller Bearings
	140	37	NN3018MBKRE1CC1P4	I	Super Precision Bearings
	140	42	53218	E1	Thrust Ball Bearings
	140	48	7018ASTRDULP3	D	Super Precision Bearings
	140	48	7018ASTRDUMP3	D	Super Precision Bearings
	140	48	7018CTRDULP3	D	Super Precision Bearings
	140	48	7018CTRDUMP3	D	Super Precision Bearings
	140	48	T7018CTDULP3	D	Super Precision Bearings
	140	66	RS-5018DSE7NAS5	H6	Cylindrical Roller Bearings
	140	67	NNCF5018V	I2	Cylindrical Roller Bearings
	150	45	33118J	F	Tapered Roller Bearings
	155	39	29318E	O	Spherical Roller Bearings
	155	50	51318	E	Thrust Ball Bearings
	160	30	1218J	G	Double Row Self Aligning Ball Bearings
	160	30	1218KJ	G1	Double Row Self Aligning Ball Bearings
	160	30	6218	B	Single Row Radial Ball Bearings
	160	30	6218DDU	B2	Single Row Radial Ball Bearings
	160	30	6218M	B	Single Row Radial Ball Bearings
	160	30	6218NR	B3	Single Row Radial Ball Bearings
	160	30	6218Z	B1	Single Row Radial Ball Bearings
	160	30	6218ZZ	B1	Single Row Radial Ball Bearings
	160	30	7218BW	D	Single Row Angular Contact Ball Bearings
	160	30	7218BWG	D	Single Row Angular Contact Ball Bearings

Selection by Dimensions (Metric)

Bore Diameter 90 mm

Bore Diameter	OD	Width	Part Number	Type	Bearing Type
90	160	30	BL218Z	C2	Single Row Radial Ball Bearings
	160	30	N218W	H	Cylindrical Roller Bearings
	160	30	NF218W	H4	Cylindrical Roller Bearings
	160	30	NJ218ET	H1	Cylindrical Roller Bearings
	160	30	NJ218W	H1	Cylindrical Roller Bearings
	160	30	NU218EM	H2	Cylindrical Roller Bearings
	160	30	NU218ET	H2	Cylindrical Roller Bearings
	160	30	NU218W	H2	Cylindrical Roller Bearings
	160	30	NUP218EM	H3	Cylindrical Roller Bearings
	160	30	NUP218ET	H3	Cylindrical Roller Bearings
	160	30	NUP218W	H3	Cylindrical Roller Bearings
	160	32,5	30218J	F	Tapered Roller Bearings
	160	40	2218J	G	Double Row Self Aligning Ball Bearings
	160	40	2218KJ	G1	Double Row Self Aligning Ball Bearings
	160	40	22218CAME4	K	Spherical Roller Bearings
	160	40	22218CAMKE4	K1	Spherical Roller Bearings
	160	40	22218EAE4	K	Spherical Roller Bearings
	160	40	22218EAKE4	K1	Spherical Roller Bearings
	160	40	22218EJW33	K	Spherical Roller Bearings
	160	40	22218EKJW33	K1	Spherical Roller Bearings
	160	40	4218BTN	L	Double Row Ball Bearings
	160	40	NJ2218ET	H1	Cylindrical Roller Bearings
	160	40	NJ2218W	H1	Cylindrical Roller Bearings
	160	40	NU2218ET	H2	Cylindrical Roller Bearings
	160	40	NU2218M	H2	Cylindrical Roller Bearings
	160	40	NU2218W	H2	Cylindrical Roller Bearings
	160	40	NUP2218M	H3	Cylindrical Roller Bearings
	160	42,5	32218J	F	Tapered Roller Bearings
	160	52,4	23218CAMKE4	K1	Spherical Roller Bearings
	160	52,4	23218CE4	K	Spherical Roller Bearings
	160	52,4	23218CKE4	K1	Spherical Roller Bearings
	160	52,4	23218EJW33	K	Spherical Roller Bearings
	160	52,4	23218EKJW33	K1	Spherical Roller Bearings
	160	59	53318	E1	Thrust Ball Bearings
	160	60	7218ASTRDULP3	D	Super Precision Bearings
	160	60	7218ASTRDUMP3	D	Super Precision Bearings
	160	60	7218CTRDULP3	D	Super Precision Bearings
	190	43	1318J	G	Double Row Self Aligning Ball Bearings
	190	43	1318KJ	G1	Double Row Self Aligning Ball Bearings
	190	43	21318EAE4	K	Spherical Roller Bearings
	190	43	21318EAKE4	K1	Spherical Roller Bearings
	190	43	21318KM	K1	Spherical Roller Bearings
	190	43	21318M	K	Spherical Roller Bearings
	190	43	6318	B	Single Row Radial Ball Bearings
	190	43	6318DDU	B2	Single Row Radial Ball Bearings
	190	43	6318M	B	Single Row Radial Ball Bearings
	190	43	6318Z	B1	Single Row Radial Ball Bearings
	190	43	6318ZZ	B1	Single Row Radial Ball Bearings
	190	43	7318BW	D	Single Row Angular Contact Ball Bearings
	190	43	7318BWG	D	Single Row Angular Contact Ball Bearings
	190	43	N318ET	H	Cylindrical Roller Bearings
	190	43	N318M	H	Cylindrical Roller Bearings
	190	43	N318W	H	Cylindrical Roller Bearings
	190	43	NJ318ET	H1	Cylindrical Roller Bearings
	190	43	NJ318W	H1	Cylindrical Roller Bearings
	190	43	NJ319W	H1	Cylindrical Roller Bearings
	190	43	NU318EM	H2	Cylindrical Roller Bearings
	190	43	NU318ET	H2	Cylindrical Roller Bearings
	190	43	NU318W	H2	Cylindrical Roller Bearings
	190	43	NUP318ET	H3	Cylindrical Roller Bearings
	190	46,5	30318J	F	Tapered Roller Bearings
	190	46,5	31318J	F	Tapered Roller Bearings

Selection by Dimensions (Metric)

Bore Diameter 90 – 95 mm

Bore Diameter	OD	Width	Part Number	Type	Bearing Type	
90	190	60	29418E	O	Spherical Roller Bearings	
	190	64	22318CAME4C4VE	K	Spherical Roller Bearings	
	190	64	22318CAMKE4	K1	Spherical Roller Bearings	
	190	64	22318EAE4	K	Spherical Roller Bearings	
	190	64	22318EAKE4	K1	Spherical Roller Bearings	
	190	64	22318EJW33	K	Spherical Roller Bearings	
	190	64	22318EKJW33	K1	Spherical Roller Bearings	
	190	64	22318VEC4	K	Spherical Roller Bearings	
	190	64	2318J	G	Double Row Self Aligning Ball Bearings	
	190	64	2318KJ	G1	Double Row Self Aligning Ball Bearings	
	190	64	NJ2318M	H1	Cylindrical Roller Bearings	
	190	64	NJ2318W	H1	Cylindrical Roller Bearings	
	190	64	NU2318M	H2	Cylindrical Roller Bearings	
	190	64	NU2318W	H2	Cylindrical Roller Bearings	
	190	64	NUP2318M	H3	Cylindrical Roller Bearings	
	190	67,5	32318J	F	Tapered Roller Bearings	
	190	77	51418	E	Thrust Ball Bearings	
		225	54	6418	B	Single Row Radial Ball Bearings
225		54	7418BMG	D	Single Row Angular Contact Ball Bearings	
225		54	NJ418M	H1	Cylindrical Roller Bearings	
225		54	NU418M	H2	Cylindrical Roller Bearings	
225		98,42	HDJK90M	P1	Double Row Angular Contact Ball Bearings	
95	120	13	6819	B	Single Row Radial Ball Bearings	
	120	13	6819DD	B2	Single Row Radial Ball Bearings	
	120	13	6819VV	B6	Single Row Radial Ball Bearings	
	130	18	6919	B	Single Row Radial Ball Bearings	
	130	18	6919ZZ	B1	Single Row Radial Ball Bearings	
	130	18	7919ASTRV1VSULP3	D	Super Precision Bearings	
	130	18	7919ASTRV1VSUMP3	D	Super Precision Bearings	
	130	18	7919CTRV1VSULP3	D	Super Precision Bearings	
	130	18	7919CTRV1VSUMP3	D	Super Precision Bearings	
	130	36	7919ASTRDULP3	D	Super Precision Bearings	
	130	36	7919ASTRDUMP3	D	Super Precision Bearings	
	130	36	7919CTRDULP3	D	Super Precision Bearings	
	130	36	7919CTRDUMP3	D	Super Precision Bearings	
	145	16	16019	B	Single Row Radial Ball Bearings	
	145	24	6019	B	Single Row Radial Ball Bearings	
	145	24	6019DDU	B2	Single Row Radial Ball Bearings	
	145	24	6019TCG12P4	B	Super Precision Bearings	
	145	24	6019TCG12P4	B	Super Precision Bearings	
	145	24	6019Z	B1	Single Row Radial Ball Bearings	
	145	24	6019ZZ	B1	Single Row Radial Ball Bearings	
	145	24	NU1019M	H2	Cylindrical Roller Bearings	
	145	32	32019XJ	F	Tapered Roller Bearings	
	145	37	NN3019MBKRCC1P4	I	Super Precision Bearings	
	145	48	7019ASTRDULP3	D	Super Precision Bearings	
	145	48	7019ASTRDUMP3	D	Super Precision Bearings	
	145	48	7019CTRDULP3	D	Super Precision Bearings	
	145	48	7019CTRDUMP3	D	Super Precision Bearings	
	145	66	RS-5019DSE7NAS5	H6	Cylindrical Roller Bearings	
		160	67	52222	N	Thrust Ball Bearings
		170	32	1219J	G	Double Row Self Aligning Ball Bearings
170		32	1219KJ	G1	Double Row Self Aligning Ball Bearings	
170		32	6219	B	Single Row Radial Ball Bearings	
170		32	6219DDU	B2	Single Row Radial Ball Bearings	
170		32	6219NR	B3	Single Row Radial Ball Bearings	
170		32	6219Z	B1	Single Row Radial Ball Bearings	
170		32	6219ZZ	B1	Single Row Radial Ball Bearings	
170		32	7219BW	D	Single Row Angular Contact Ball Bearings	
170		32	7219BWG	D	Single Row Angular Contact Ball Bearings	

Selection by Dimensions (Metric)

Bore Diameter 95 mm

Bore Diameter	OD	Width	Part Number	Type	Bearing Type	
95	170	32	NU219W	H	Cylindrical Roller Bearings	
	170	32	NF219W	H4	Cylindrical Roller Bearings	
	170	32	NJ219EM	H1	Cylindrical Roller Bearings	
	170	32	NJ219ET	H1	Cylindrical Roller Bearings	
	170	32	NJ219W	H1	Cylindrical Roller Bearings	
	170	32	NU219EM	H2	Cylindrical Roller Bearings	
	170	32	NU219ET	H2	Cylindrical Roller Bearings	
	170	32	NU219W	H2	Cylindrical Roller Bearings	
	170	32	NUP219ET	H3	Cylindrical Roller Bearings	
	170	32	NUP219W	H3	Cylindrical Roller Bearings	
	170	34,5	30219J	F	Tapered Roller Bearings	
	170	43	2219J	G	Double Row Self Aligning Ball Bearings	
	170	43	2219KJ	G1	Double Row Self Aligning Ball Bearings	
	170	43	22219EAE4	K	Spherical Roller Bearings	
	170	43	22219EAKE4	K1	Spherical Roller Bearings	
	170	43	22219EJW33	K	Spherical Roller Bearings	
	170	43	22219EKJW33	K1	Spherical Roller Bearings	
	170	43	NJ2219W	H1	Cylindrical Roller Bearings	
	170	43	NU2219ET	H2	Cylindrical Roller Bearings	
	170	43	NU2219M	H2	Cylindrical Roller Bearings	
	170	43	NU2219W	H2	Cylindrical Roller Bearings	
	170	43	NUP2219M	H3	Cylindrical Roller Bearings	
	170	45,5	32219J	F	Tapered Roller Bearings	
	170	64	7219ASTRDULP3	D	Super Precision Bearings	
	170	64	7219ASTRDUMP3	D	Super Precision Bearings	
	170	64	7219CTRDULP3	D	Super Precision Bearings	
		195	128	54322	N1	Thrust Ball Bearings
		200	45	1319J	G	Double Row Self Aligning Ball Bearings
		200	45	1319KJ	G1	Double Row Self Aligning Ball Bearings
		200	45	21319CE4	K	Spherical Roller Bearings
200		45	21319CKE4	K1	Spherical Roller Bearings	
200		45	6319	B	Single Row Radial Ball Bearings	
200		45	6319DDU	B2	Single Row Radial Ball Bearings	
200		45	6319M	B	Single Row Radial Ball Bearings	
200		45	6319Z	B1	Single Row Radial Ball Bearings	
200		45	6319ZZ	B1	Single Row Radial Ball Bearings	
200		45	7319BW	D	Single Row Angular Contact Ball Bearings	
200		45	7319BWG	D	Single Row Angular Contact Ball Bearings	
200		45	N319M	H	Cylindrical Roller Bearings	
200		45	N319W	H	Cylindrical Roller Bearings	
200		45	NU319EM	H2	Cylindrical Roller Bearings	
200		45	NU319ET	H2	Cylindrical Roller Bearings	
200		45	NU319W	H2	Cylindrical Roller Bearings	
200		49,5	30319J	F	Tapered Roller Bearings	
200		49,5	31319J	F	Tapered Roller Bearings	
200		67	22319CAME4C4VE	K	Spherical Roller Bearings	
200		67	22319CAME4	K	Spherical Roller Bearings	
200		67	22319CAMKE4	K1	Spherical Roller Bearings	
200		67	22319EAE4	K	Spherical Roller Bearings	
200		67	22319EAKE4	K1	Spherical Roller Bearings	
200		67	22319EJW33	K	Spherical Roller Bearings	
200		67	22319EKJW33	K1	Spherical Roller Bearings	
200		67	22319EKMW33	K1	Spherical Roller Bearings	
200		67	22319EMW33	K	Spherical Roller Bearings	
200		67	22319VEC4	K	Spherical Roller Bearings	
200		67	NJ2319W	H1	Cylindrical Roller Bearings	
200		67	NU2319M	H2	Cylindrical Roller Bearings	
200		67	NU2319W	H2	Cylindrical Roller Bearings	
200		67	NUP2319M	H3	Cylindrical Roller Bearings	
200		71,5	32319J	F	Tapered Roller Bearings	
		240	55	NU419M	H2	Cylindrical Roller Bearings

Selection by Dimensions (Metric)

Bore Diameter 100 mm

Bore Diameter	OD	Width	Part Number	Type	Bearing Type
100	125	13	6820	B	Single Row Radial Ball Bearings
	125	13	6820DD	B2	Single Row Radial Ball Bearings
	125	13	6820VV	B6	Single Row Radial Ball Bearings
	125	13	6820ZZ	B1	Single Row Radial Ball Bearings
	135	25	51120	E	Thrust Ball Bearings
	140	20	6920	B	Single Row Radial Ball Bearings
	140	20	6920ZZ	B1	Single Row Radial Ball Bearings
	140	20	7920ASTRV1VSULP3	D	Super Precision Bearings
	140	20	7920ASTRV1VSUMP3	D	Super Precision Bearings
	140	20	7920CTRV1VSULP3	D	Super Precision Bearings
	140	20	7920CTRV1VSUMP3	D	Super Precision Bearings
	140	24	NCF2920V	H5	Cylindrical Roller Bearings
	140	25	32920J	F	Tapered Roller Bearings
	140	40	7920ASTRDULP3	D	Super Precision Bearings
	140	40	7920ASTRDUMP3	D	Super Precision Bearings
	140	40	7920CTRDULP3	D	Super Precision Bearings
	140	40	7920CTRDUMP3	D	Super Precision Bearings
	140	40	NNU4920MBKRE2CC1P4	I1	Super Precision Bearings
	150	16	16020	B	Single Row Radial Ball Bearings
	150	24	6020	B	Single Row Radial Ball Bearings
	150	24	6020DDU	B2	Single Row Radial Ball Bearings
	150	24	6020DU	B2	Single Row Radial Ball Bearings
	150	24	6020M	B	Single Row Radial Ball Bearings
	150	24	6020NR	B3	Single Row Radial Ball Bearings
	150	24	6020TCG12P4	B	Super Precision Bearings
	150	24	6020TCG12P4	B	Super Precision Bearings
	150	24	6020VV	B6	Single Row Radial Ball Bearings
	150	24	6020Z	B1	Single Row Radial Ball Bearings
	150	24	6020ZZ	B1	Single Row Radial Ball Bearings
	150	24	7020ASTRV1VSULP3	D	Super Precision Bearings
	150	24	7020ASTRV1VSUMP3	D	Super Precision Bearings
	150	24	7020CTRV1VSULP3	D	Super Precision Bearings
	150	24	7020CTRV1VSUMP3	D	Super Precision Bearings
	150	24	NU1020M	H2	Cylindrical Roller Bearings
	150	32	32020XJ	F	Tapered Roller Bearings
	150	37	NCF3020V	H5	Cylindrical Roller Bearings
	150	37	NN3020MBKRCC1P4	I	Super Precision Bearings
	150	38	51220	E	Thrust Ball Bearings
	150	45	BSB100150DUHP3	D	Super Precision Bearings
	150	48	7020ASTRDULP3	D	Super Precision Bearings
	150	48	7020ASTRDUMP3	D	Super Precision Bearings
	150	48	7020CTRDULP3	D	Super Precision Bearings
	150	48	7020CTRDUMP3	D	Super Precision Bearings
	150	66	RS-5020DSE7NAS5	H6	Cylindrical Roller Bearings
	150	67	NNCF5020V	I2	Cylindrical Roller Bearings
	155	45	53220	E1	Thrust Ball Bearings
	165	52	23120CE4	K	Spherical Roller Bearings
	165	52	23120CKE4	K1	Spherical Roller Bearings
	165	52	23120EMW33	K	Spherical Roller Bearings
	165	65	24120CAME4	K	Spherical Roller Bearings
	170	42	29320E	O	Spherical Roller Bearings
	170	55	51320	E	Thrust Ball Bearings
	170	68	52224	N	Thrust Ball Bearings
	175	64	53320	E1	Thrust Ball Bearings
	180	34	1220J	G	Double Row Self Aligning Ball Bearings
	180	34	1220KJ	G1	Double Row Self Aligning Ball Bearings
	180	34	6220	B	Single Row Radial Ball Bearings
	180	34	6220DDU	B2	Single Row Radial Ball Bearings
	180	34	6220M	B	Single Row Radial Ball Bearings

Selection by Dimensions (Metric)

Bore Diameter 100 mm

Bore Diameter	OD	Width	Part Number	Type	Bearing Type
100	180	34	6220NR	B3	Single Row Radial Ball Bearings
	180	34	6220Z	B1	Single Row Radial Ball Bearings
	180	34	6220ZZ	B1	Single Row Radial Ball Bearings
	180	34	7220BW	D	Single Row Angular Contact Ball Bearings
	180	34	7220BWG	D	Single Row Angular Contact Ball Bearings
	180	34	N220W	H	Cylindrical Roller Bearings
	180	34	NF220W	H4	Cylindrical Roller Bearings
	180	34	NJ220EM	H1	Cylindrical Roller Bearings
	180	34	NJ220ET	H1	Cylindrical Roller Bearings
	180	34	NJ220W	H1	Cylindrical Roller Bearings
	180	34	NU220EM	H2	Cylindrical Roller Bearings
	180	34	NU220ET	H2	Cylindrical Roller Bearings
	180	34	NU220W	H2	Cylindrical Roller Bearings
	180	34	NUP220ET	H3	Cylindrical Roller Bearings
	180	34	NUP220W	H3	Cylindrical Roller Bearings
	180	37	30220J	F	Tapered Roller Bearings
	180	46	2220J	G	Double Row Self Aligning Ball Bearings
	180	46	2220KJ	G1	Double Row Self Aligning Ball Bearings
	180	46	22220CAME4	K	Spherical Roller Bearings
	180	46	22220CAMKE4	K1	Spherical Roller Bearings
	180	46	22220EAE4	K	Spherical Roller Bearings
	180	46	22220EAKE4	K1	Spherical Roller Bearings
	180	46	22220EJW33	K	Spherical Roller Bearings
	180	46	22220EKJW33	K1	Spherical Roller Bearings
	180	46	NJ220ET	H1	Cylindrical Roller Bearings
	180	46	NJ220W	H1	Cylindrical Roller Bearings
	180	46	NU2220M	H2	Cylindrical Roller Bearings
	180	46	NU2220W	H2	Cylindrical Roller Bearings
	180	46	NUP2220M	H3	Cylindrical Roller Bearings
	180	49	32220J	F	Tapered Roller Bearings
	180	60,3	23220CE4	K	Spherical Roller Bearings
	180	60,3	23220CKE4	K1	Spherical Roller Bearings
	180	60,3	23220EJW33	K	Spherical Roller Bearings
	180	60,3	23220EKJW33	K1	Spherical Roller Bearings
	180	63	33220J	F	Tapered Roller Bearings
	180	64	7220ASTRDULP3	D	Super Precision Bearings
	180	64	7220CTRDULP3	D	Super Precision Bearings
	180	64	7220CTRDUMP3	D	Super Precision Bearings
	210	67	29420E	O	Spherical Roller Bearings
	210	85	51420M	E	Thrust Ball Bearings
	215	47	1320J	G	Double Row Self Aligning Ball Bearings
	215	47	1320KJ	G1	Double Row Self Aligning Ball Bearings
	215	47	21320CAME4	K	Spherical Roller Bearings
	215	47	21320CAMK	K1	Spherical Roller Bearings
	215	47	6320	B	Single Row Radial Ball Bearings
	215	47	6320DDU	B2	Single Row Radial Ball Bearings
	215	47	6320M	B	Single Row Radial Ball Bearings
	215	47	6320Z	B1	Single Row Radial Ball Bearings
	215	47	6320ZZ	B1	Single Row Radial Ball Bearings
	215	47	7320BM	D	Single Row Angular Contact Ball Bearings
	215	47	7320BMG	D	Single Row Angular Contact Ball Bearings
	215	47	7320BW	D	Single Row Angular Contact Ball Bearings
	215	47	7320BWG	D	Single Row Angular Contact Ball Bearings
	215	47	N320ET	H	Cylindrical Roller Bearings
	215	47	N320M	H	Cylindrical Roller Bearings
	215	47	N320W	H	Cylindrical Roller Bearings
	215	47	NJ320ET	H1	Cylindrical Roller Bearings
	215	47	NJ320W	H1	Cylindrical Roller Bearings
	215	47	NU320EM	H2	Cylindrical Roller Bearings
	215	47	NU320ET	H2	Cylindrical Roller Bearings
	215	47	NU320W	H2	Cylindrical Roller Bearings

Selection by Dimensions (Metric)

Bore Diameter 100 – 105 mm

Bore Diameter	OD	Width	Part Number	Type	Bearing Type
100	215	47	NUP320ET	H3	Cylindrical Roller Bearings
	215	51,5	30320J	F	Tapered Roller Bearings
	215	56,5	31320J	F	Tapered Roller Bearings
	215	73	22320CAME4	K	Spherical Roller Bearings
	215	73	22320CAME4C4VE	K	Spherical Roller Bearings
	215	73	22320CAMKE4	K1	Spherical Roller Bearings
	215	73	22320EAE4	K	Spherical Roller Bearings
	215	73	22320EAKE4	K1	Spherical Roller Bearings
	215	73	22320EJW33	K	Spherical Roller Bearings
	215	73	22320EKJW33	K1	Spherical Roller Bearings
	215	73	22320EKMW33	K1	Spherical Roller Bearings
	215	73	22320KVEC4	K1	Spherical Roller Bearings
	215	73	22320EMW33	K	Spherical Roller Bearings
	215	73	22320VEC4	K	Spherical Roller Bearings
	215	73	NJ2320M	H1	Cylindrical Roller Bearings
	215	73	NJ2320W	H1	Cylindrical Roller Bearings
	215	73	NU2320M	H2	Cylindrical Roller Bearings
	215	73	NU2320W	H2	Cylindrical Roller Bearings
	215	73	NUP2320M	H3	Cylindrical Roller Bearings
	215	77,5	32320J	F	Tapered Roller Bearings
	250	58	NU420M	H2	Cylindrical Roller Bearings
105	130	13	6821	B	Single Row Radial Ball Bearings
	130	13	6821VV	B6	Single Row Radial Ball Bearings
	145	20	6921	B	Single Row Radial Ball Bearings
	145	20	6921ZZ	B1	Single Row Radial Ball Bearings
	145	40	7921ASTRDULP3	D	Super Precision Bearings
	145	40	7921ASTRDUMP3	D	Super Precision Bearings
	145	40	7921CTRDULP3	D	Super Precision Bearings
	145	40	7921CTRDUMP3	D	Super Precision Bearings
	145	40	NNU4921MBKRE1CC1P4	I1	Super Precision Bearings
	160	18	16021	B	Single Row Radial Ball Bearings
	160	26	6021	B	Single Row Radial Ball Bearings
	160	26	6021DDU	B2	Single Row Radial Ball Bearings
	160	26	6021Z	B1	Single Row Radial Ball Bearings
	160	26	6021ZZ	B1	Single Row Radial Ball Bearings
	160	26	7021ASTRV1VSULP3	D	Super Precision Bearings
	160	26	7021CTRV1VSULP3	D	Super Precision Bearings
	160	26	NU1021M	H2	Cylindrical Roller Bearings
	160	35	32021XJ	F	Tapered Roller Bearings
	160	41	NN3021MBKRCC1P4	I	Super Precision Bearings
	160	43	33021J	F	Tapered Roller Bearings
	160	52	7021ASTRDULP3	D	Super Precision Bearings
	160	52	7021ASTRDUMP3	D	Super Precision Bearings
	160	52	7021CTRDULP3	D	Super Precision Bearings
	160	52	7021CTRDUMP3	D	Super Precision Bearings
	190	36	1221J	G	Double Row Self Aligning Ball Bearings
	190	36	6221	B	Single Row Radial Ball Bearings
	190	36	6221DDU	B2	Single Row Radial Ball Bearings
	190	36	6221NR	B3	Single Row Radial Ball Bearings
	190	36	6221ZZ	B1	Single Row Radial Ball Bearings
	190	36	7221BMG	D	Single Row Angular Contact Ball Bearings
	190	36	7221BW	D	Single Row Angular Contact Ball Bearings
	190	36	N221M	H	Cylindrical Roller Bearings
	190	36	NJ221EM	H1	Cylindrical Roller Bearings
	190	36	NJ221W	H1	Cylindrical Roller Bearings
	190	36	NU221W	H2	Cylindrical Roller Bearings
	190	39	30221J	F	Tapered Roller Bearings
	190	50	2221J	G	Double Row Self Aligning Ball Bearings
	190	53	32221J	F	Tapered Roller Bearings
	190	72	7221CTRDULP3	D	Super Precision Bearings

Selection by Dimensions (Metric)

Bore Diameter 105 – 110 mm

Bore Diameter	OD	Width	Part Number	Type	Bearing Type
105	225	49	1321J	G	Double Row Self Aligning Ball Bearings
	225	49	6321	B	Single Row Radial Ball Bearings
	225	49	6321M	B	Single Row Radial Ball Bearings
	225	49	6321ZZ	B1	Single Row Radial Ball Bearings
	225	49	7321BM	D	Single Row Angular Contact Ball Bearings
	225	49	7321BMG	D	Single Row Angular Contact Ball Bearings
	225	49	N321M	H	Cylindrical Roller Bearings
	225	49	N321W	H	Cylindrical Roller Bearings
	225	49	NF321M	H4	Cylindrical Roller Bearings
	225	49	NJ321W	H1	Cylindrical Roller Bearings
	225	49	NU321EM	H2	Cylindrical Roller Bearings
	225	49	NU321W	H2	Cylindrical Roller Bearings
	225	53,5	30321J	F	Tapered Roller Bearings
	225	81,5	32321J	F	Tapered Roller Bearings
		260	60	NJ421M	H1
260		60	NU421M	H2	Cylindrical Roller Bearings
110	140	16	6822	B	Single Row Radial Ball Bearings
	140	16	6822VV	B6	Single Row Radial Ball Bearings
	145	25	51122	E	Thrust Ball Bearings
	150	20	6922	B	Single Row Radial Ball Bearings
	150	20	6922ZZ	B1	Single Row Radial Ball Bearings
	150	24	NCF2922V	H5	Cylindrical Roller Bearings
	150	25	32922J	F	Tapered Roller Bearings
	150	40	7922ASTRDULP3	D	Super Precision Bearings
	150	40	7922ASTRDUMP3	D	Super Precision Bearings
	150	40	7922CTRDULP3	D	Super Precision Bearings
	150	40	7922CTRDUMP3	D	Super Precision Bearings
	150	40	NNU4922MBKRE1CC1P4	I1	Super Precision Bearings
	150	40	7922CTRDUMP3	D	Super Precision Bearings
	160	38	51222	E	Thrust Ball Bearings
	165	45	53222	E1	Thrust Ball Bearings
	170	19	16022	B	Single Row Radial Ball Bearings
	170	28	6022	B	Single Row Radial Ball Bearings
	170	28	6022DDU	B2	Single Row Radial Ball Bearings
	170	28	6022NR	B3	Single Row Radial Ball Bearings
	170	28	6022TCG12P4	B	Super Precision Bearings
	170	28	6022Z	B1	Single Row Radial Ball Bearings
	170	28	6022ZZ	B1	Single Row Radial Ball Bearings
	170	28	NU1022M	H2	Cylindrical Roller Bearings
	170	38	32022XJ	F	Tapered Roller Bearings
	170	45	23022CDE4	K	Spherical Roller Bearings
	170	45	23022CDKE4	K1	Spherical Roller Bearings
	170	45	23022EJW33	K	Spherical Roller Bearings
	170	45	NN3022MBKRCC1P4	I	Super Precision Bearings
	170	47	33022J	F	Tapered Roller Bearings
	170	56	7022ASTRDULP3	D	Super Precision Bearings
	170	56	7022ASTRDUMP3	D	Super Precision Bearings
	170	56	7022CTRDULP3	D	Super Precision Bearings
	170	56	7022CTRDUMP3	D	Super Precision Bearings
	170	79	RS-5022DSE7NA55	H6	Cylindrical Roller Bearings
		180	56	23122CAME4	K
180		56	23122CAMKE4	K1	Spherical Roller Bearings
180		56	23122CE4	K	Spherical Roller Bearings
180		56	23122CKE4	K1	Spherical Roller Bearings
180		56	23122EJW33	K	Spherical Roller Bearings
180		56	23122EKJW33	K1	Spherical Roller Bearings
180		69	24122CAME4	K	Spherical Roller Bearings
180		69	24122CE4	K	Spherical Roller Bearings
180		69	24122CK30E4	K1	Spherical Roller Bearings
180		69	24122JW33	K	Spherical Roller Bearings

Selection by Dimensions (Metric)

Bore Diameter 110 mm

Bore Diameter	OD	Width	Part Number	Type	Bearing Type
110	190	48	29322E	O	Spherical Roller Bearings
	190	63	51322	E	Thrust Ball Bearings
	190	80	52226	N	Thrust Ball Bearings
	195	72	53322	E1	Thrust Ball Bearings
	200	38	1222J	G	Double Row Self Aligning Ball Bearings
	200	38	1222K	G1	Double Row Self Aligning Ball Bearings
	200	38	6222	B	Single Row Radial Ball Bearings
	200	38	6222DDU	B2	Single Row Radial Ball Bearings
	200	38	6222M	B	Single Row Radial Ball Bearings
	200	38	6222Z	B1	Single Row Radial Ball Bearings
	200	38	6222ZZ	B1	Single Row Radial Ball Bearings
	200	38	7222BW	D	Single Row Angular Contact Ball Bearings
	200	38	7222BWG	D	Single Row Angular Contact Ball Bearings
	200	38	N222M	H	Cylindrical Roller Bearings
	200	38	N222W	H	Cylindrical Roller Bearings
	200	38	NJ222EM	H1	Cylindrical Roller Bearings
	200	38	NJ222W	H1	Cylindrical Roller Bearings
	200	38	NU222EM	H2	Cylindrical Roller Bearings
	200	38	NU222W	H2	Cylindrical Roller Bearings
	200	41	3022J	F	Tapered Roller Bearings
	200	53	2222J	G	Double Row Self Aligning Ball Bearings
	200	53	2222CAME4	K	Spherical Roller Bearings
	200	53	2222CAME4	K1	Spherical Roller Bearings
	200	53	2222EAE4	K	Spherical Roller Bearings
	200	53	2222EAE4	K1	Spherical Roller Bearings
	200	53	2222EJW33	K	Spherical Roller Bearings
	200	53	2222EKJW33	K1	Spherical Roller Bearings
	200	53	2222KJ	G1	Double Row Self Aligning Ball Bearings
	200	53	NJ222M	H1	Cylindrical Roller Bearings
	200	53	NJ222W	H1	Cylindrical Roller Bearings
	200	53	NU222M	H2	Cylindrical Roller Bearings
	200	53	NU222W	H2	Cylindrical Roller Bearings
	200	53	NUP222M	H3	Cylindrical Roller Bearings
	200	56	3222J	F	Tapered Roller Bearings
	200	69,8	2322CAME4	K	Spherical Roller Bearings
	200	69,8	2322CAME4	K1	Spherical Roller Bearings
	200	69,8	2322CE4	K	Spherical Roller Bearings
	200	69,8	2322CE4	K1	Spherical Roller Bearings
	200	69,8	2322EKMW33	K1	Spherical Roller Bearings
	200	69,8	2322EMW33	K	Spherical Roller Bearings
	230	73	29422E	O	Spherical Roller Bearings
	230	95	51422M	E	Thrust Ball Bearings
	240	50	1322J	G	Double Row Self Aligning Ball Bearings
	240	50	21322CAME4	K	Spherical Roller Bearings
	240	50	6322	B	Single Row Radial Ball Bearings
	240	50	6322M	B	Single Row Radial Ball Bearings
	240	50	6322ZZ	B1	Single Row Radial Ball Bearings
	240	50	7322BM	D	Single Row Angular Contact Ball Bearings
	240	50	7322BMG	D	Single Row Angular Contact Ball Bearings
	240	50	7322BW	D	Single Row Angular Contact Ball Bearings
	240	50	7322BWG	D	Single Row Angular Contact Ball Bearings
	240	50	N322M	H	Cylindrical Roller Bearings
	240	50	N322W	H	Cylindrical Roller Bearings
	240	50	NJ322W	H1	Cylindrical Roller Bearings
	240	50	NU322EM	H2	Cylindrical Roller Bearings
	240	50	NU322W	H2	Cylindrical Roller Bearings
	240	54,5	30322J	F	Tapered Roller Bearings
	240	63	3132J	F	Tapered Roller Bearings
	240	80	22322CAME4C4VE	K	Spherical Roller Bearings
	240	80	22322CAME4	K	Spherical Roller Bearings

Selection by Dimensions (Metric)

Bore Diameter 110 – 120 mm

Bore Diameter	OD	Width	Part Number	Type	Bearing Type
110	240	80	22322CAMKE4	K1	Spherical Roller Bearings
	240	80	22322EAE4	K	Spherical Roller Bearings
	240	80	22322EAKE4	K1	Spherical Roller Bearings
	240	80	22322EKMW33	K1	Spherical Roller Bearings
	240	80	22322KVEC4	K1	Spherical Roller Bearings
	240	80	22322EMW33	K	Spherical Roller Bearings
	240	80	22322VEC4	K	Spherical Roller Bearings
	240	80	NJ2322M	H1	Cylindrical Roller Bearings
	240	80	NU2322M	H2	Cylindrical Roller Bearings
	240	84,5	32322J	F	Tapered Roller Bearings
	280	65	NJ422M	H1	Cylindrical Roller Bearings
120	150	16	6824	B	Single Row Radial Ball Bearings
	150	16	6824DD	B2	Single Row Radial Ball Bearings
	150	16	6824VV	B6	Single Row Radial Ball Bearings
	155	25	51124	E	Thrust Ball Bearings
	165	22	6924	B	Single Row Radial Ball Bearings
	165	22	6924ZZ	B1	Single Row Radial Ball Bearings
	165	27	NCF2924V	H5	Cylindrical Roller Bearings
	165	29	32924J	F	Tapered Roller Bearings
	165	44	7924ASTRDULP3	D	Super Precision Bearings
	165	44	7924ASTRDUMP3	D	Super Precision Bearings
	165	44	7924CTRDULP3	D	Super Precision Bearings
	165	44	7924CTRDUMP3	D	Super Precision Bearings
	170	39	51224	E	Thrust Ball Bearings
	175	46	53224	E1	Thrust Ball Bearings
	180	19	16024	B	Single Row Radial Ball Bearings
	180	28	6024	B	Single Row Radial Ball Bearings
	180	28	6024DDU	B2	Single Row Radial Ball Bearings
	180	28	6024M	B	Single Row Radial Ball Bearings
	180	28	6024NR	B3	Single Row Radial Ball Bearings
	180	28	6024VV	B6	Single Row Radial Ball Bearings
	180	28	6024Z	B1	Single Row Radial Ball Bearings
	180	28	6024ZZ	B1	Single Row Radial Ball Bearings
	180	28	NU1024M	H2	Cylindrical Roller Bearings
	180	38	32024XJ	F	Tapered Roller Bearings
	180	46	23024CDE4	K	Spherical Roller Bearings
	180	46	23024CDKE4	K1	Spherical Roller Bearings
	180	46	23024EJW33	K	Spherical Roller Bearings
	180	46	23024EKJW33	K1	Spherical Roller Bearings
	180	46	NCF3024V	H5	Cylindrical Roller Bearings
	180	46	NN3024MBKRE1CC1P4	I	Super Precision Bearings
	180	48	33024J	F	Tapered Roller Bearings
	180	56	7024ASTRDULP3	D	Super Precision Bearings
	180	56	7024ASTRDUMP3	D	Super Precision Bearings
	180	56	7024CTRDULP3	D	Super Precision Bearings
	180	56	7024CTRDUMP3	D	Super Precision Bearings
	180	60	24024CAME4	K	Spherical Roller Bearings
	180	60	24024CE4	K	Spherical Roller Bearings
180	60	24024JW33	K	Spherical Roller Bearings	
180	79	RS-5024DSE7NAS5	H6	Cylindrical Roller Bearings	
	200	62	23124CAME4	K	Spherical Roller Bearings
	200	62	23124CAMKE4	K1	Spherical Roller Bearings
	200	62	23124CE4	K	Spherical Roller Bearings
	200	62	23124CKE4	K1	Spherical Roller Bearings
	200	62	23124EKMW33	K1	Spherical Roller Bearings
	200	62	23124EMW33	K	Spherical Roller Bearings
	200	80	24124CAME4	K	Spherical Roller Bearings
	200	80	24124CAMK30E4	K1	Spherical Roller Bearings
	200	80	24124CE4	K	Spherical Roller Bearings

Selection by Dimensions (Metric)

Bore Diameter 120 mm

Bore Diameter	OD	Width	Part Number	Type	Bearing Type
120	200	80	24124CK30E4	K1	Spherical Roller Bearings
	200	80	24124JW33	K	Spherical Roller Bearings
	200	81	52228	N	Thrust Ball Bearings
	210	54	29324E	O	Spherical Roller Bearings
	210	70	51324	E	Thrust Ball Bearings
	215	40	1224M	G	Double Row Self Aligning Ball Bearings
	215	40	6224	B	Single Row Radial Ball Bearings
	215	40	6224DDU	B2	Single Row Radial Ball Bearings
	215	40	6224M	B	Single Row Radial Ball Bearings
	215	40	6224ZZ	B1	Single Row Radial Ball Bearings
	215	40	7224BM	D	Single Row Angular Contact Ball Bearings
	215	40	7224BMG	D	Single Row Angular Contact Ball Bearings
	215	40	N224M	H	Cylindrical Roller Bearings
	215	40	N224W	H	Cylindrical Roller Bearings
	215	40	NJ224EM	H1	Cylindrical Roller Bearings
	215	40	NJ224W	H1	Cylindrical Roller Bearings
	215	40	NU224EM	H2	Cylindrical Roller Bearings
	215	40	NU224W	H2	Cylindrical Roller Bearings
	215	40	NUP224EM	H3	Cylindrical Roller Bearings
	215	43,5	30224J	F	Tapered Roller Bearings
	215	58	22224CAME4	K	Spherical Roller Bearings
	215	58	22224CAMKE4	K1	Spherical Roller Bearings
	215	58	22224EAE4	K	Spherical Roller Bearings
	215	58	22224EAKE4	K1	Spherical Roller Bearings
	215	58	22224EJW33	K	Spherical Roller Bearings
	215	58	22224EKJW33	K1	Spherical Roller Bearings
	215	58	NJ2224M	H1	Cylindrical Roller Bearings
	215	58	NJ2224W	H1	Cylindrical Roller Bearings
	215	58	NU2224M	H2	Cylindrical Roller Bearings
	215	58	NU2224W	H2	Cylindrical Roller Bearings
	215	61,5	32224J	F	Tapered Roller Bearings
	215	76	23224CAME4	K	Spherical Roller Bearings
	215	76	23224CAMKE4	K1	Spherical Roller Bearings
	215	76	23224CE4	K	Spherical Roller Bearings
	215	76	23224CKE4	K1	Spherical Roller Bearings
	215	76	23224KMW33	K1	Spherical Roller Bearings
	215	76	23224MW33	K	Spherical Roller Bearings
215	80	7224ASTRDULP3	D	Super Precision Bearings	
215	80	7224CTRDULP3	D	Super Precision Bearings	
	220	80	53324	E1	Thrust Ball Bearings
	250	102	51424M	E	Thrust Ball Bearings
	250	78	29424E	O	Spherical Roller Bearings
	260	55	6324	B	Single Row Radial Ball Bearings
	260	55	6324DDU	B2	Single Row Radial Ball Bearings
	260	55	6324M	B	Single Row Radial Ball Bearings
	260	55	7324BM	D	Single Row Angular Contact Ball Bearings
	260	55	7324BMG	D	Single Row Angular Contact Ball Bearings
	260	55	N324M	H	Cylindrical Roller Bearings
	260	55	N324W	H	Cylindrical Roller Bearings
	260	55	NJ324W	H1	Cylindrical Roller Bearings
	260	55	NU324EM	H2	Cylindrical Roller Bearings
	260	55	NU324W	H2	Cylindrical Roller Bearings
	260	68	31324J	F	Tapered Roller Bearings
	260	86	22324CAME4C4VE	K	Spherical Roller Bearings
	260	86	22324CAME4	K	Spherical Roller Bearings
	260	86	22324CAMKE4	K1	Spherical Roller Bearings
	260	86	22324EAE4	K	Spherical Roller Bearings
	260	86	22324EAKE4	K1	Spherical Roller Bearings
	260	86	22324EKMW33	K1	Spherical Roller Bearings
	260	86	22324EMW33	K	Spherical Roller Bearings

Selection by Dimensions (Metric)

Bore Diameter 120 – 130 mm

Bore Diameter	OD	Width	Part Number	Type	Bearing Type
120	260	86	22324VEC4	K	Spherical Roller Bearings
	260	86	NJ2324M	H1	Cylindrical Roller Bearings
	260	86	NU2324M	H2	Cylindrical Roller Bearings
	260	90,5	32324J	F	Tapered Roller Bearings
130	165	18	6826	B	Single Row Radial Ball Bearings
	165	18	6826DD	B2	Single Row Radial Ball Bearings
	165	18	6826VV	B6	Single Row Radial Ball Bearings
	170	30	51126	E	Thrust Ball Bearings
	180	24	6926	B	Single Row Radial Ball Bearings
	180	24	6926ZZ	B1	Single Row Radial Ball Bearings
	180	30	NCF2926V	H5	Cylindrical Roller Bearings
	180	32	32926J	F	Tapered Roller Bearings
	180	48	7926ASTRDULP3	D	Super Precision Bearings
	180	48	7926ASTRDUMP3	D	Super Precision Bearings
	180	48	7926CTRDULP3	D	Super Precision Bearings
	180	50	NNU4926MBKRE3CC1P4	I1	Super Precision Bearings
	190	45	51226	E	Thrust Ball Bearings
	195	53	53226	E1	Thrust Ball Bearings
	200	22	16026	B	Single Row Radial Ball Bearings
	200	33	6026	B	Single Row Radial Ball Bearings
	200	33	6026DDU	B2	Single Row Radial Ball Bearings
	200	33	6026ZZ	B1	Single Row Radial Ball Bearings
	200	33	NU1026M	H2	Cylindrical Roller Bearings
	200	45	32026XJ	F	Tapered Roller Bearings
	200	52	23026CDE4	K	Spherical Roller Bearings
	200	52	23026CDKE4	K1	Spherical Roller Bearings
	200	52	23026EJW33	K	Spherical Roller Bearings
	200	52	23026EKJW33	K1	Spherical Roller Bearings
	200	52	NN3026MBKRE2CC1P4	I	Super Precision Bearings
	200	66	7026ASTRDULP3	D	Super Precision Bearings
	200	66	7026ASTRDUMP3	D	Super Precision Bearings
	200	66	7026CTRDULP3	D	Super Precision Bearings
	200	69	24026CAME4	K	Spherical Roller Bearings
	200	69	24026CE4	K	Spherical Roller Bearings
	200	69	24026CK30E4	K1	Spherical Roller Bearings
	200	69	24026JW33	K	Spherical Roller Bearings
	200	94	RS-5026DSE7NAS5	H6	Cylindrical Roller Bearings
	200	95	NNCF5026V	I2	Cylindrical Roller Bearings
	210	64	23126CAME4	K	Spherical Roller Bearings
	210	64	23126CAMKE4	K1	Spherical Roller Bearings
	210	64	23126CE4	K	Spherical Roller Bearings
	210	64	23126CKE4	K1	Spherical Roller Bearings
	210	64	23126EKMW33	K1	Spherical Roller Bearings
	210	64	23126EMW33	K	Spherical Roller Bearings
	210	80	24126CAME4	K	Spherical Roller Bearings
	210	80	24126CE4	K	Spherical Roller Bearings
	210	80	24126CK30E4	K1	Spherical Roller Bearings
	210	80	24126JW33	K	Spherical Roller Bearings
	215	89	52230	N	Thrust Ball Bearings
	225	58	29326E	O	Spherical Roller Bearings
	225	75	51326	E	Thrust Ball Bearings
	230	40	6226	B	Single Row Radial Ball Bearings
	230	40	6226ZZ	B1	Single Row Radial Ball Bearings
	230	40	7226BM	D	Single Row Angular Contact Ball Bearings
	230	40	7226BMG	D	Single Row Angular Contact Ball Bearings
	230	40	N226M	H	Cylindrical Roller Bearings
	230	40	N226W	H	Cylindrical Roller Bearings
	230	40	NJ226W	H1	Cylindrical Roller Bearings

Selection by Dimensions (Metric)

Bore Diameter 130 – 140 mm

Bore Diameter	OD	Width	Part Number	Type	Bearing Type	
130	230	40	NU226EM	H2	Cylindrical Roller Bearings	
	230	40	NU226W	H2	Cylindrical Roller Bearings	
	230	40	NUP226M	H3	Cylindrical Roller Bearings	
	230	43,75	30226J	F	Tapered Roller Bearings	
	230	64	22226CAME4	K	Spherical Roller Bearings	
	230	64	22226CAMKE4	K1	Spherical Roller Bearings	
	230	64	22226EAE4	K	Spherical Roller Bearings	
	230	64	22226EAKE4	K1	Spherical Roller Bearings	
	230	64	22226EJW33	K	Spherical Roller Bearings	
	230	64	22226EKJW33	K1	Spherical Roller Bearings	
	230	64	NJ2226M	H1	Cylindrical Roller Bearings	
	230	64	NJ2226W	H1	Cylindrical Roller Bearings	
	230	64	NU2226M	H2	Cylindrical Roller Bearings	
	230	64	NU2226W	H2	Cylindrical Roller Bearings	
	230	67,75	32226J	F	Tapered Roller Bearings	
	230	80	23226CAME4	K	Spherical Roller Bearings	
	230	80	23226CAMKE4	K1	Spherical Roller Bearings	
	230	80	23226CE4	K	Spherical Roller Bearings	
	230	80	23226CKE4	K1	Spherical Roller Bearings	
	230	80	23226EKMW33	K1	Spherical Roller Bearings	
	230	80	23226EMW33	K	Spherical Roller Bearings	
	230	80	7226CTRDUMP3	D	Super Precision Bearings	
		235	86	53326	E1	Thrust Ball Bearings
		270	85	29426E	O	Spherical Roller Bearings
	280	280	58	6326	B	Single Row Radial Ball Bearings
		280	58	6326M	B	Single Row Radial Ball Bearings
280		58	7326BM	D	Single Row Angular Contact Ball Bearings	
280		58	7326BMG	D	Single Row Angular Contact Ball Bearings	
280		58	N326M	H	Cylindrical Roller Bearings	
280		58	NJ326M	H1	Cylindrical Roller Bearings	
280		58	NJ326W	H1	Cylindrical Roller Bearings	
280		58	NU326M	H2	Cylindrical Roller Bearings	
280		58	NU326W	H2	Cylindrical Roller Bearings	
280		58	NUP326M	H3	Cylindrical Roller Bearings	
280		93	22326CAME4C4VE	K	Spherical Roller Bearings	
280		93	22326CAME4	K	Spherical Roller Bearings	
280		93	22326CAMKE4	K1	Spherical Roller Bearings	
280		93	22326EKMW33	K1	Spherical Roller Bearings	
280		93	22326EMW33	K	Spherical Roller Bearings	
280		93	22326VEC4	K	Spherical Roller Bearings	
280		93	NJ2326M	H1	Cylindrical Roller Bearings	
280		93	NU2326M	H2	Cylindrical Roller Bearings	
280		98,75	32326	F	Tapered Roller Bearings	
140		175	18	6828	B	Single Row Radial Ball Bearings
	175	18	6828DDU	B2	Single Row Radial Ball Bearings	
	175	18	6828VV	B6	Single Row Radial Ball Bearings	
	175	18	6828ZZ	B1	Single Row Radial Ball Bearings	
	180	31	51128	E	Thrust Ball Bearings	
190	190	24	6928	B	Single Row Radial Ball Bearings	
	190	30	NCF2928V	H5	Cylindrical Roller Bearings	
	190	32	32928J	F	Tapered Roller Bearings	
	190	48	7928ASTRDULP3	D	Super Precision Bearings	
	190	48	7928ASTRDUMP3	D	Super Precision Bearings	
	190	48	7928CTRDUMP3	D	Super Precision Bearings	
	190	50	NNU4928MBKRE2CC1P4	I1	Super Precision Bearings	
		200	46	51228	E	Thrust Ball Bearings
210	210	22	16028M	B	Single Row Radial Ball Bearings	
	210	33	6028	B	Single Row Radial Ball Bearings	
	210	33	6028DDU	B2	Single Row Radial Ball Bearings	

Selection by Dimensions (Metric)

Bore Diameter 140 mm

Bore Diameter	OD	Width	Part Number	Type	Bearing Type	
140	210	33	6028ZZ	B1	Single Row Radial Ball Bearings	
	210	33	NU1028M	H2	Cylindrical Roller Bearings	
	210	45	32028XJ	F	Tapered Roller Bearings	
	210	53	23028CAME4	K	Spherical Roller Bearings	
	210	53	23028CDE4	K	Spherical Roller Bearings	
	210	53	23028CDKE4	K1	Spherical Roller Bearings	
	210	53	23028EJW33	K	Spherical Roller Bearings	
	210	53	23028EKJW33	K1	Spherical Roller Bearings	
	210	53	NN3028MBKRE2CC1P4	I	Super Precision Bearings	
	210	55	53228	E1	Thrust Ball Bearings	
	210	66	7028ASTRDUMP3	D	Super Precision Bearings	
	210	66	7028CTRDULP3	D	Super Precision Bearings	
	210	66	7028CTRDUMP3	D	Super Precision Bearings	
	210	69	24028CAME4	K	Spherical Roller Bearings	
	210	69	24028CE4	K	Spherical Roller Bearings	
	210	69	24028CK30E4	K1	Spherical Roller Bearings	
	210	69	24028JW33	K	Spherical Roller Bearings	
	210	94	RS-5028DSE7NAS5	H6	Cylindrical Roller Bearings	
		225	68	23128CAME4	K	Spherical Roller Bearings
		225	68	23128CAMKE4	K1	Spherical Roller Bearings
225		68	23128CE4	K	Spherical Roller Bearings	
225		68	23128CKE4	K1	Spherical Roller Bearings	
225		68	23128EKMW33	K1	Spherical Roller Bearings	
225		68	23128EMW33	K	Spherical Roller Bearings	
225		85	24128CAME4	K	Spherical Roller Bearings	
225		85	24128CE4	K	Spherical Roller Bearings	
225		85	24128CK30E4	K1	Spherical Roller Bearings	
225		85	24128JW33	K	Spherical Roller Bearings	
225		90	52232	N	Thrust Ball Bearings	
		240	60	29328E	O	Spherical Roller Bearings
	240	80	51328	E	Thrust Ball Bearings	
	250	42	6228	B	Single Row Radial Ball Bearings	
	250	42	6228M	B	Single Row Radial Ball Bearings	
	250	42	7228BMG	D	Single Row Angular Contact Ball Bearings	
	250	42	N228M	H	Cylindrical Roller Bearings	
	250	42	N228W	H	Cylindrical Roller Bearings	
	250	42	NJ228M	H1	Cylindrical Roller Bearings	
	250	42	NJ228W	H1	Cylindrical Roller Bearings	
	250	42	NU228M	H2	Cylindrical Roller Bearings	
	250	42	NU228W	H2	Cylindrical Roller Bearings	
	250	42	NUP228M	H3	Cylindrical Roller Bearings	
	250	45,75	30228J	F	Tapered Roller Bearings	
	250	68	22228CAME4	K	Spherical Roller Bearings	
	250	68	22228CAMKE4	K1	Spherical Roller Bearings	
	250	68	22228CDE4	K	Spherical Roller Bearings	
	250	68	22228CDKE4	K1	Spherical Roller Bearings	
	250	68	22228EJW33	K	Spherical Roller Bearings	
	250	68	22228EKJW33	K1	Spherical Roller Bearings	
	250	68	NJ2228M	H1	Cylindrical Roller Bearings	
	250	68	NJ2228W	H1	Cylindrical Roller Bearings	
	250	68	NU2228M	H2	Cylindrical Roller Bearings	
	250	68	NU2228W	H2	Cylindrical Roller Bearings	
	250	71,75	32228J	F	Tapered Roller Bearings	
	250	88	23228CAME4	K	Spherical Roller Bearings	
	250	88	23228CAMKE4	K1	Spherical Roller Bearings	
	250	88	23228CE4	K	Spherical Roller Bearings	
	250	88	23228CKE4	K1	Spherical Roller Bearings	
	250	88	23228EKMW33	K1	Spherical Roller Bearings	
	250	88	23228EMW33	K	Spherical Roller Bearings	
	280	85	29428E	O	Spherical Roller Bearings	

Selection by Dimensions (Metric)

Bore Diameter 140 – 150 mm

Bore Diameter	OD	Width	Part Number	Type	Bearing Type	
140	300	102	22328CAME4C4VE	K	Spherical Roller Bearings	
	300	102	22328CAME4	K	Spherical Roller Bearings	
	300	102	22328CAMKE4	K1	Spherical Roller Bearings	
	300	102	22328EKMW33	K1	Spherical Roller Bearings	
	300	102	22328EKVBC4	K1	Spherical Roller Bearings	
	300	102	22328EMW33	K	Spherical Roller Bearings	
	300	102	22328VEC4	K	Spherical Roller Bearings	
	300	102	NU2328M	H2	Cylindrical Roller Bearings	
	300	107,8	32328	F	Tapered Roller Bearings	
	300	58	NJ328M	H1	Cylindrical Roller Bearings	
	300	62	6328	B	Single Row Radial Ball Bearings	
	300	62	6328M	B	Single Row Radial Ball Bearings	
	300	62	7328BM	D	Single Row Angular Contact Ball Bearings	
	300	62	7328BMG	D	Single Row Angular Contact Ball Bearings	
	300	62	N328M	H	Cylindrical Roller Bearings	
	300	62	NF328M	H4	Cylindrical Roller Bearings	
	300	62	NU328M	H2	Cylindrical Roller Bearings	
	300	62	NU328W	H2	Cylindrical Roller Bearings	
	300	62	NUP328M	H3	Cylindrical Roller Bearings	
	300	77	31328J	F	Tapered Roller Bearings	
	80	44,4	3216M	M	Double Row Angular Contact Ball Bearings	
150	190	20	6830	B	Single Row Radial Ball Bearings	
	190	20	6830M	B	Single Row Radial Ball Bearings	
	190	31	51130	E	Thrust Ball Bearings	
	210	28	6930	B	Single Row Radial Ball Bearings	
	210	28	6930DDU	B2	Single Row Radial Ball Bearings	
	210	36	NCF2930V	H5	Cylindrical Roller Bearings	
	210	38	32930	F	Tapered Roller Bearings	
	210	56	7930CTRDUMP3	D	Super Precision Bearings	
	210	60	NNU4930MBKRE2CC1P4	I1	Super Precision Bearings	
		215	50	51230	E	Thrust Ball Bearings
		225	24	16030	B	Single Row Radial Ball Bearings
		225	24	16030M	B	Single Row Radial Ball Bearings
		225	35	6030	B	Single Row Radial Ball Bearings
		225	35	6030DDU	B2	Single Row Radial Ball Bearings
		225	35	6030M	B	Single Row Radial Ball Bearings
		225	35	6030ZZ	B1	Single Row Radial Ball Bearings
		225	35	NU1030M	H2	Cylindrical Roller Bearings
		225	48	32030XJ	F	Tapered Roller Bearings
		225	56	23030CAME4	K	Spherical Roller Bearings
		225	56	23030CDE4	K	Spherical Roller Bearings
	225	56	23030CDKE4	K1	Spherical Roller Bearings	
	225	56	23030EKMW33	K1	Spherical Roller Bearings	
	225	56	23030EMW33	K	Spherical Roller Bearings	
	225	56	NCF3030V	H5	Cylindrical Roller Bearings	
	225	56	NN3030MBKRE1CC1P4	I	Super Precision Bearings	
	225	70	7030ASTRDULP3	D	Super Precision Bearings	
	225	70	7030CTRDUMP3	D	Super Precision Bearings	
	225	75	24030CAME4	K	Spherical Roller Bearings	
	225	75	24030CE4	K	Spherical Roller Bearings	
	225	75	24030CK30E4	K1	Spherical Roller Bearings	
	225	75	24030EJW33	K	Spherical Roller Bearings	
	225	99	RS-5030DSE7NAS5	H6	Cylindrical Roller Bearings	
	240	97	52234	N	Thrust Ball Bearings	
	250	100	24130CAME4	K	Spherical Roller Bearings	
	250	100	24130CAMK30E4	K1	Spherical Roller Bearings	
	250	100	24130CE4	K	Spherical Roller Bearings	
	250	100	24130CK30E4	K1	Spherical Roller Bearings	
	250	100	24130JW33	K	Spherical Roller Bearings	

Selection by Dimensions (Metric)

Bore Diameter 150 – 160 mm

Bore Diameter	OD	Width	Part Number	Type	Bearing Type	
150	250	60	29330E	O	Spherical Roller Bearings	
	250	80	23130CAME4	K	Spherical Roller Bearings	
	250	80	23130CAMKE4	K1	Spherical Roller Bearings	
	250	80	23130CE4	K	Spherical Roller Bearings	
	250	80	23130CKE4	K1	Spherical Roller Bearings	
	250	80	23130EKMW33	K1	Spherical Roller Bearings	
	250	80	23130EMW33	K	Spherical Roller Bearings	
	250	80	51330	E	Thrust Ball Bearings	
270	270	45	6230	B	Single Row Radial Ball Bearings	
	270	45	6230M	B	Single Row Radial Ball Bearings	
	270	45	7230BMG	D	Single Row Angular Contact Ball Bearings	
	270	45	N230M	H	Cylindrical Roller Bearings	
	270	45	N230W	H	Cylindrical Roller Bearings	
	270	45	NJ230M	H1	Cylindrical Roller Bearings	
	270	45	NJ230W	H1	Cylindrical Roller Bearings	
	270	45	NU230M	H2	Cylindrical Roller Bearings	
	270	45	NU230W	H2	Cylindrical Roller Bearings	
	270	49	30230	F	Tapered Roller Bearings	
	270	73	22230CAME4	K	Spherical Roller Bearings	
	270	73	22230CAMK	K1	Spherical Roller Bearings	
	270	73	22230CDE4	K	Spherical Roller Bearings	
	270	73	22230CDKE4	K1	Spherical Roller Bearings	
	270	73	22230EKMW33	K1	Spherical Roller Bearings	
	270	73	22230EMW33	K	Spherical Roller Bearings	
	270	73	NJ2230M	H1	Cylindrical Roller Bearings	
	270	73	NU2230M	H2	Cylindrical Roller Bearings	
	270	77	32230J	F	Tapered Roller Bearings	
	270	96	23230CAME4	K	Spherical Roller Bearings	
	270	96	23230CAMKE4	K1	Spherical Roller Bearings	
	270	96	23230CE4	K	Spherical Roller Bearings	
	270	96	23230CKE4	K1	Spherical Roller Bearings	
	270	96	23230EKMW33	K1	Spherical Roller Bearings	
	270	96	23230EMW33	K	Spherical Roller Bearings	
	300	300	90	29430E	O	Spherical Roller Bearings
	320	320	108	22330CAME4C4VE	K	Spherical Roller Bearings
320		108	22330CAME4	K	Spherical Roller Bearings	
320		108	22330CAMKE4	K1	Spherical Roller Bearings	
320		108	22330EKMW33	K1	Spherical Roller Bearings	
320		108	22330EMW33	K	Spherical Roller Bearings	
320		108	22330VEC4	K	Spherical Roller Bearings	
320		108	NU2330M	H2	Cylindrical Roller Bearings	
320		114	32330	F	Tapered Roller Bearings	
320		65	6330	B	Single Row Radial Ball Bearings	
320		65	6330M	B	Single Row Radial Ball Bearings	
320		65	7330BM	D	Single Row Angular Contact Ball Bearings	
320		65	7330BMG	D	Single Row Angular Contact Ball Bearings	
320		65	NJ330M	H1	Cylindrical Roller Bearings	
320		65	NU330M	H2	Cylindrical Roller Bearings	
320		65	NU330W	H2	Cylindrical Roller Bearings	
320		82	31330J	F	Tapered Roller Bearings	
160		200	20	6832	B	Single Row Radial Ball Bearings
	200	20	6832M	B	Single Row Radial Ball Bearings	
	200	31	51132	E	Thrust Ball Bearings	
220	220	28	6932	B	Single Row Radial Ball Bearings	
	220	36	NCF2932V	H5	Cylindrical Roller Bearings	
	220	38	32932	F	Tapered Roller Bearings	
	220	56	7932A5TRDULP3	D	Super Precision Bearings	
	220	56	7932A5TRDUMP3	D	Super Precision Bearings	
	220	56	7932CTRDULP3	D	Super Precision Bearings	
	220	60	NNU4932MBKRE2CC1P4	I1	Super Precision Bearings	

Selection by Dimensions (Metric)

Bore Diameter 160 mm

Bore Diameter	OD	Width	Part Number	Type	Bearing Type
160	225	39	29232M	O	Spherical Roller Bearings
	225	51	51232	E	Thrust Ball Bearings
	240	108	RS-5032DSE7NAS5	H6	Cylindrical Roller Bearings
	240	25	16032M	B	Single Row Radial Ball Bearings
	240	38	6032	B	Single Row Radial Ball Bearings
	240	38	6032DDU	B2	Single Row Radial Ball Bearings
	240	38	6032M	B	Single Row Radial Ball Bearings
	240	38	NU1032M	H2	Cylindrical Roller Bearings
	240	51	32032XJ	F	Tapered Roller Bearings
	240	60	23032CAME4	K	Spherical Roller Bearings
	240	60	23032CDE4	K	Spherical Roller Bearings
	240	60	23032CDKE4	K1	Spherical Roller Bearings
	240	60	23032EKMW33	K1	Spherical Roller Bearings
	240	60	23032EMW33	K	Spherical Roller Bearings
	240	60	NCF3032V	H5	Cylindrical Roller Bearings
	240	76	7032ASTRDUMP3	D	Super Precision Bearings
	240	80	24032CAME4	K	Spherical Roller Bearings
	240	80	24032CAMK30E4	K1	Spherical Roller Bearings
	240	80	24032CE4	K	Spherical Roller Bearings
	240	80	24032CK30E4	K1	Spherical Roller Bearings
	270	109	24132CAME4	K	Spherical Roller Bearings
	270	109	24132CE4	K	Spherical Roller Bearings
	270	109	24132CK30E4	K1	Spherical Roller Bearings
	270	109	24132JW33	K	Spherical Roller Bearings
	270	67	29332E	O	Spherical Roller Bearings
	270	86	23132CAME4	K	Spherical Roller Bearings
	270	86	23132CAMKE4	K1	Spherical Roller Bearings
	270	86	23132CE4	K	Spherical Roller Bearings
	270	86	23132CKE4	K1	Spherical Roller Bearings
	270	86	23132EKMW33	K1	Spherical Roller Bearings
	270	86	23132EMW33	K	Spherical Roller Bearings
	270	87	51332	E	Thrust Ball Bearings
	290	104	23232CAME4	K	Spherical Roller Bearings
	290	104	23232CAMKE4	K1	Spherical Roller Bearings
	290	104	23232CE4	K	Spherical Roller Bearings
	290	104	23232CKE4	K1	Spherical Roller Bearings
	290	104	23232EKMW33	K1	Spherical Roller Bearings
	290	104	23232EMW33	K	Spherical Roller Bearings
	290	48	6232	B	Single Row Radial Ball Bearings
	290	48	6232M	B	Single Row Radial Ball Bearings
	290	48	N232M	H	Cylindrical Roller Bearings
	290	48	NJ232M	H1	Cylindrical Roller Bearings
	290	48	NU232M	H2	Cylindrical Roller Bearings
	290	52	30232	F	Tapered Roller Bearings
	290	80	22232CAME4	K	Spherical Roller Bearings
	290	80	22232CAMKE4	K1	Spherical Roller Bearings
	290	80	22232CDE4	K	Spherical Roller Bearings
	290	80	22232CDKE4	K1	Spherical Roller Bearings
	290	80	22232EKMW33	K1	Spherical Roller Bearings
290	80	22232EMW33	K	Spherical Roller Bearings	
290	80	NU2232M	H2	Cylindrical Roller Bearings	
290	84	32232J	F	Tapered Roller Bearings	
	320	95	29432E	O	Spherical Roller Bearings
	340	114	22332CAME4C4VE	K	Spherical Roller Bearings
	340	114	22332CAME4	K	Spherical Roller Bearings
	340	114	22332CAMKE4	K1	Spherical Roller Bearings
	340	114	22332EKMW33	K1	Spherical Roller Bearings
	340	114	22332EKVBC4	K1	Spherical Roller Bearings
	340	114	22332EMW33	K	Spherical Roller Bearings
	340	114	22332VEC4	K	Spherical Roller Bearings

Selection by Dimensions (Metric)

Bore Diameter 160 – 170 mm

Bore Diameter	OD	Width	Part Number	Type	Bearing Type
160	340	114	NU2332M	H2	Cylindrical Roller Bearings
	340	121	32332	F	Tapered Roller Bearings
	340	68	6332	B	Single Row Radial Ball Bearings
	340	68	6332M	B	Single Row Radial Ball Bearings
	340	68	7332BM	D	Single Row Angular Contact Ball Bearings
	340	68	7332BMG	D	Single Row Angular Contact Ball Bearings
	340	68	NU332M	H2	Cylindrical Roller Bearings
	90	52,4	3218M	M	Double Row Angular Contact Ball Bearings
170	215	22	6834	B	Single Row Radial Ball Bearings
	215	22	6834M	B	Single Row Radial Ball Bearings
	215	34	51134	E	Thrust Ball Bearings
	230	28	6934	B	Single Row Radial Ball Bearings
	230	36	NCF2934V	H5	Cylindrical Roller Bearings
	230	38	32934J	F	Tapered Roller Bearings
	230	56	7934CTRDULP3	D	Super Precision Bearings
	230	56	7934CTRDUMP3	D	Super Precision Bearings
	230	60	NNU4934MBKRE3CC1P4	I1	Super Precision Bearings
	240	42	29234M	K	Spherical Roller Bearings
	240	55	51234	E	Thrust Ball Bearings
	260	121	RS-5034DSE7NAS5	H6	Cylindrical Roller Bearings
	260	28	16034M	B	Single Row Radial Ball Bearings
	260	42	6034	B	Single Row Radial Ball Bearings
	260	42	6034M	B	Single Row Radial Ball Bearings
260	42	NU1034M	H2	Cylindrical Roller Bearings	
260	57	32034XJ	F	Tapered Roller Bearings	
260	67	23034CAME4	K	Spherical Roller Bearings	
260	67	23034CDE4	K	Spherical Roller Bearings	
260	67	23034CDKE4	K1	Spherical Roller Bearings	
260	67	23034EKMW33	K1	Spherical Roller Bearings	
260	67	23034EMW33	K	Spherical Roller Bearings	
260	84	7034CTRDUMP3	D	Super Precision Bearings	
260	90	24034CAME4	K	Spherical Roller Bearings	
260	90	24034CE4	K	Spherical Roller Bearings	
260	90	24034CK30E4	K1	Spherical Roller Bearings	
260	90	24034EJW33	K	Spherical Roller Bearings	
280	109	24134CAME4	K	Spherical Roller Bearings	
280	109	24134CE4	K	Spherical Roller Bearings	
280	109	24134CK30E4	K1	Spherical Roller Bearings	
280	109	24134JW33	K	Spherical Roller Bearings	
280	67	29334E	O	Spherical Roller Bearings	
280	87	51334	E	Thrust Ball Bearings	
280	88	23134CAME4	K	Spherical Roller Bearings	
280	88	23134CE4	K	Spherical Roller Bearings	
280	88	23134CKE4	K1	Spherical Roller Bearings	
280	88	23134EKMW33	K1	Spherical Roller Bearings	
280	88	23134EMW33	K	Spherical Roller Bearings	
310	110	23234CAME4	K	Spherical Roller Bearings	
310	110	23234CAMKE4	K1	Spherical Roller Bearings	
310	110	23234CE4	K	Spherical Roller Bearings	
310	110	23234CKE4	K1	Spherical Roller Bearings	
310	52	6234	B	Single Row Radial Ball Bearings	
310	52	6234M	B	Single Row Radial Ball Bearings	
310	52	7234BMG	D	Single Row Angular Contact Ball Bearings	
310	52	NJ234M	H1	Cylindrical Roller Bearings	
310	52	NU234M	H2	Cylindrical Roller Bearings	
310	57	30234	F	Tapered Roller Bearings	
310	86	22234CAME4	K	Spherical Roller Bearings	
310	86	22234CAMKE4	K1	Spherical Roller Bearings	
310	86	22234CDE4	K	Spherical Roller Bearings	

Selection by Dimensions (Metric)

Bore Diameter 170 – 180 mm

Bore Diameter	OD	Width	Part Number	Type	Bearing Type
170	310	86	22234CDKE4	K1	Spherical Roller Bearings
	310	86	22234EKMW33	K1	Spherical Roller Bearings
	310	86	22234EMW33	K	Spherical Roller Bearings
	310	86	NU2234M	H2	Cylindrical Roller Bearings
	310	91	32234J	F	Tapered Roller Bearings
	340	103	29434M	O	Spherical Roller Bearings
	360	120	22334CAME4C4VE	K	Spherical Roller Bearings
	360	120	22334CAME4	K	Spherical Roller Bearings
	360	120	22334CAMKE4	K1	Spherical Roller Bearings
	360	120	22334EKMW33	K1	Spherical Roller Bearings
	360	120	22334EMW33	K	Spherical Roller Bearings
	360	127	32334	F	Tapered Roller Bearings
	360	72	6334M	B	Single Row Radial Ball Bearings
	360	72	7334BMG	D	Single Row Angular Contact Ball Bearings
	360	72	NU334M	H2	Cylindrical Roller Bearings
180	225	22	6836	B	Single Row Radial Ball Bearings
	225	22	6836M	B	Single Row Radial Ball Bearings
	225	34	51136	E	Thrust Ball Bearings
	250	33	6936M	B	Single Row Radial Ball Bearings
	250	42	29236M	O	Spherical Roller Bearings
	250	42	NCF2936V	H5	Cylindrical Roller Bearings
	250	45	32936J	F	Tapered Roller Bearings
	250	52	23936CAME4	K	Spherical Roller Bearings
	250	56	51236	E	Thrust Ball Bearings
	250	66	7936ASTRDUMP3	D	Super Precision Bearings
	250	66	7936CTRDULP3	D	Super Precision Bearings
	250	66	7936CTRDUMP3	D	Super Precision Bearings
	250	69	NNU4936MBKRE1CC1P4	I1	Super Precision Bearings
	280	100	24036CAME4	K	Spherical Roller Bearings
	280	100	24036CAMK30E4	K1	Spherical Roller Bearings
	280	100	24036CE4	K	Spherical Roller Bearings
	280	100	24036CK30E4	K1	Spherical Roller Bearings
	280	100	24036JW33	K	Spherical Roller Bearings
	280	135	RS-5036DSE7NAS5	H6	Cylindrical Roller Bearings
	280	31	16036M	B	Single Row Radial Ball Bearings
	280	46	6036	B	Single Row Radial Ball Bearings
	280	46	6036M	B	Single Row Radial Ball Bearings
	280	46	NU1036M	H2	Cylindrical Roller Bearings
	280	64	32036XJ	F	Tapered Roller Bearings
	280	74	23036CDE4	K	Spherical Roller Bearings
	280	74	23036CDKE4	K1	Spherical Roller Bearings
	280	74	23036EKMW33	K1	Spherical Roller Bearings
	280	74	23036EMW33	K	Spherical Roller Bearings
	280	74	NCF3036V	H5	Cylindrical Roller Bearings
	280	92	7036ASTRDUMP3	D	Super Precision Bearings
	300	118	24136CAME4	K	Spherical Roller Bearings
	300	118	24136CAMK30E4	K1	Spherical Roller Bearings
	300	118	24136CE4	K	Spherical Roller Bearings
	300	118	24136CK30E4	K1	Spherical Roller Bearings
	300	118	24136JW33	K	Spherical Roller Bearings
	300	73	29336E	O	Spherical Roller Bearings
	300	95	51336	E	Thrust Ball Bearings
	300	96	23136CAME4	K	Spherical Roller Bearings
	300	96	23136CAMKE4	K1	Spherical Roller Bearings
	300	96	23136CE4	K	Spherical Roller Bearings
	300	96	23136CKE4	K1	Spherical Roller Bearings
	300	96	23136EKMW33	K1	Spherical Roller Bearings
	300	96	23136EMW33	K	Spherical Roller Bearings
	320	112	23236CAME4	K	Spherical Roller Bearings

Selection by Dimensions (Metric)

Bore Diameter 180 – 190 mm

Bore Diameter	OD	Width	Part Number	Type	Bearing Type
180	320	112	23236CAMKE4	K1	Spherical Roller Bearings
	320	112	23236CE4	K	Spherical Roller Bearings
	320	112	23236CKE4	K1	Spherical Roller Bearings
	320	52	6236	B	Single Row Radial Ball Bearings
	320	52	6236M	B	Single Row Radial Ball Bearings
	320	52	7236BMG	D	Single Row Angular Contact Ball Bearings
	320	52	NJ236M	H1	Cylindrical Roller Bearings
	320	52	NU236M	H2	Cylindrical Roller Bearings
	320	57	30236	F	Tapered Roller Bearings
	320	86	22236CAME4	K	Spherical Roller Bearings
	320	86	22236CAMKE4	K1	Spherical Roller Bearings
	320	86	22236CDE4	K	Spherical Roller Bearings
	320	86	22236CDKE4	K1	Spherical Roller Bearings
	320	86	22236EKMW33	K1	Spherical Roller Bearings
	320	86	22236EMW33	K	Spherical Roller Bearings
	320	86	NU2236M	H2	Cylindrical Roller Bearings
320	91	32236J	F	Tapered Roller Bearings	
	360	109	29436M	O	Spherical Roller Bearings
380	380	126	22336CAME4C4VE	K	Spherical Roller Bearings
	380	126	22336CAME4	K	Spherical Roller Bearings
	380	126	22336CAMKE4	K1	Spherical Roller Bearings
	380	134	32336	F	Tapered Roller Bearings
	380	75	6336M	B	Single Row Radial Ball Bearings
	380	75	7336BM	D	Single Row Angular Contact Ball Bearings
	380	75	7336BMG	D	Single Row Angular Contact Ball Bearings
	380	75	NU336M	H2	Cylindrical Roller Bearings
190	240	24	6838	B	Single Row Radial Ball Bearings
	240	24	6838M	B	Single Row Radial Ball Bearings
	240	37	51138	E	Thrust Ball Bearings
260	260	33	6938M	B	Single Row Radial Ball Bearings
	260	42	NCF2938V	H5	Cylindrical Roller Bearings
	260	45	32938J	F	Tapered Roller Bearings
	260	52	23938CAME4	K	Spherical Roller Bearings
	260	66	7938ASTRDUMP3	D	Super Precision Bearings
	260	66	7938CTRDULP3	D	Super Precision Bearings
	260	69	NNU4938MBKRE1CC1P4	I1	Super Precision Bearings
270	62	51238M	E	Thrust Ball Bearings	
290	290	100	24038CAME4	K	Spherical Roller Bearings
	290	100	24038CE4	K	Spherical Roller Bearings
	290	100	24038CK30E4	K1	Spherical Roller Bearings
	290	100	24038EJW33	K	Spherical Roller Bearings
	290	135	RS-5038DSE7NAS5	H6	Cylindrical Roller Bearings
	290	31	16038M	B	Single Row Radial Ball Bearings
	290	46	6038	B	Single Row Radial Ball Bearings
	290	46	6038M	B	Single Row Radial Ball Bearings
	290	46	NU1038M	H2	Cylindrical Roller Bearings
	290	64	32038XJ	F	Tapered Roller Bearings
	290	75	23038CAME4	K	Spherical Roller Bearings
	290	75	23038CAMKE4	K1	Spherical Roller Bearings
	290	75	23038EJW33	K	Spherical Roller Bearings
	290	75	23038EKJW33	K1	Spherical Roller Bearings
	290	75	NCF3038V	H5	Cylindrical Roller Bearings
290	92	7038ASTRDUMP3	D	Super Precision Bearings	
320	320	104	23138CAME4	K	Spherical Roller Bearings
	320	104	23138CAMKE4	K1	Spherical Roller Bearings
	320	104	23138CE4	K	Spherical Roller Bearings
	320	104	23138CKE4	K1	Spherical Roller Bearings
	320	104	23138EJW33	K	Spherical Roller Bearings
	320	104	23138EKJW33	K1	Spherical Roller Bearings

Selection by Dimensions (Metric)

Bore Diameter 190 – 200 mm

Bore Diameter	OD	Width	Part Number	Type	Bearing Type
190	320	105	51338M	E	Thrust Ball Bearings
	320	128	24138CAME4	K	Spherical Roller Bearings
	320	128	24138CE4	K	Spherical Roller Bearings
	320	128	24138CK30E4	K1	Spherical Roller Bearings
	320	128	24138JW33	K	Spherical Roller Bearings
	320	78	29338E	O	Spherical Roller Bearings
340	340	120	23238CAME4	K	Spherical Roller Bearings
	340	120	23238CE4	K	Spherical Roller Bearings
	340	120	23238CKE4	K1	Spherical Roller Bearings
	340	55	6238	B	Single Row Radial Ball Bearings
	340	55	6238M	B	Single Row Radial Ball Bearings
	340	55	NJ238M	H1	Cylindrical Roller Bearings
	340	55	NU238M	H2	Cylindrical Roller Bearings
	340	92	22238CAME4	K	Spherical Roller Bearings
	340	92	22238CAMKE4	K1	Spherical Roller Bearings
	340	92	22238EKMW33	K1	Spherical Roller Bearings
	340	92	22238EMW33	K	Spherical Roller Bearings
	340	92	NU2238M	H2	Cylindrical Roller Bearings
	340	97	32238J	F	Tapered Roller Bearings
380	115	29438M	O	Spherical Roller Bearings	
400	400	132	22338CAME4C4VE	K	Spherical Roller Bearings
	400	132	22338CAME4	K	Spherical Roller Bearings
	400	132	22338CAMKE4	K1	Spherical Roller Bearings
	400	140	32338	F	Tapered Roller Bearings
	400	78	6338M	B	Single Row Radial Ball Bearings
	400	78	NU338M	H2	Cylindrical Roller Bearings
200	250	24	6840M	B	Single Row Radial Ball Bearings
	250	37	51140	E	Thrust Ball Bearings
280	280	38	6940M	B	Single Row Radial Ball Bearings
	280	48	29240M	O	Spherical Roller Bearings
	280	48	NCF2940V	H5	Cylindrical Roller Bearings
	280	51	32940J	F	Tapered Roller Bearings
	280	60	23940CAME4	K	Spherical Roller Bearings
	280	62	51240M	E	Thrust Ball Bearings
	280	76	7940ASTRDUMP3	D	Super Precision Bearings
310	310	102	7040ASTRDUMP3	D	Super Precision Bearings
	310	109	24040CAME4	K	Spherical Roller Bearings
	310	109	24040CE4	K	Spherical Roller Bearings
	310	109	24040CK30E4	K1	Spherical Roller Bearings
	310	109	24040EJW33	K	Spherical Roller Bearings
	310	149	RS-5040DSE7NAS5	H6	Cylindrical Roller Bearings
	310	34	16040M	B	Single Row Radial Ball Bearings
	310	51	6040	B	Single Row Radial Ball Bearings
	310	51	6040M	B	Single Row Radial Ball Bearings
	310	51	NU1040M	H2	Cylindrical Roller Bearings
	310	70	32040XJ	F	Tapered Roller Bearings
	310	82	23040CAME4	K	Spherical Roller Bearings
	310	82	23040CAMKE4	K1	Spherical Roller Bearings
	310	82	23040EKMW33	K1	Spherical Roller Bearings
	310	82	23040EMW33	K	Spherical Roller Bearings
310	82	NCF3040V	H5	Cylindrical Roller Bearings	
340	340	112	23140CAME4	K	Spherical Roller Bearings
	340	112	23140CAMKE4	K1	Spherical Roller Bearings
	340	112	23140CE4	K	Spherical Roller Bearings
	340	112	23140CKE4	K1	Spherical Roller Bearings
	340	140	24140CAME4	K	Spherical Roller Bearings
	340	140	24140CE4	K	Spherical Roller Bearings
	340	140	24140CK30E4	K1	Spherical Roller Bearings
	340	140	24140EJW33	K	Spherical Roller Bearings

Selection by Dimensions (Metric)

Bore Diameter 200 – 220 mm

Bore Diameter	OD	Width	Part Number	Type	Bearing Type
200	340	85	29340E	O	Spherical Roller Bearings
	360	104	32240	F	Tapered Roller Bearings
	360	128	23240CAME4	K	Spherical Roller Bearings
	360	128	23240CAMKE4	K1	Spherical Roller Bearings
	360	128	23240CE4	K	Spherical Roller Bearings
	360	128	23240CKE4	K1	Spherical Roller Bearings
	360	58	6240M	B	Single Row Radial Ball Bearings
	360	58	NJ240M	H1	Cylindrical Roller Bearings
	360	58	NU240M	H2	Cylindrical Roller Bearings
	360	98	22240CAME4	K	Spherical Roller Bearings
	360	98	22240CAMKE4	K1	Spherical Roller Bearings
	360	98	22240EKMW33	K1	Spherical Roller Bearings
	360	98	22240EMW33	K	Spherical Roller Bearings
	360	98	NU2240M	H2	Cylindrical Roller Bearings
	400	122	29440M	O	Spherical Roller Bearings
	420	138	22340CAME4C4VE	K	Spherical Roller Bearings
	420	138	22340CAME4	K	Spherical Roller Bearings
	420	138	22340CAMKE4	K1	Spherical Roller Bearings
	420	80	NU340M	H2	Cylindrical Roller Bearings
220	270	24	6844M	B	Single Row Radial Ball Bearings
	270	37	51144	E	Thrust Ball Bearings
	300	38	6944M	B	Single Row Radial Ball Bearings
	300	48	29244M	O	Spherical Roller Bearings
	300	48	NCF2944V	H5	Cylindrical Roller Bearings
	300	51	32944J	F	Tapered Roller Bearings
	300	60	23944CAME4	K	Spherical Roller Bearings
	300	60	23944CAMKE4	K1	Spherical Roller Bearings
	300	63	51244M	E	Thrust Ball Bearings
	340	118	24044CAME4	K	Spherical Roller Bearings
	340	118	24044CAMK30E4	K1	Spherical Roller Bearings
	340	118	24044CE4	K	Spherical Roller Bearings
	340	118	24044CK30E4	K1	Spherical Roller Bearings
	340	118	24044EJW33	K	Spherical Roller Bearings
	340	37	16044M	B	Single Row Radial Ball Bearings
	340	56	6044M	B	Single Row Radial Ball Bearings
	340	56	NU1044M	H2	Cylindrical Roller Bearings
	340	76	32044XJ	F	Tapered Roller Bearings
	340	90	23044CAME4	K	Spherical Roller Bearings
	340	90	23044CAMKE4	K1	Spherical Roller Bearings
	340	90	23044EKMW33	K1	Spherical Roller Bearings
	340	90	23044EMW33	K	Spherical Roller Bearings
	340	90	NCF3044V	H5	Cylindrical Roller Bearings
	360	85	29344M	O	Spherical Roller Bearings
	370	120	23144CAME4	K	Spherical Roller Bearings
	370	120	23144CAMKE4	K1	Spherical Roller Bearings
	370	120	23144CE4	K	Spherical Roller Bearings
	370	120	23144CKE4	K1	Spherical Roller Bearings
	370	120	23144EJW33	K	Spherical Roller Bearings
	370	120	23144EKJW33	K1	Spherical Roller Bearings
	370	150	24144CAME4	K	Spherical Roller Bearings
	370	150	24144CE4	K	Spherical Roller Bearings
	370	150	24144EJW33	K	Spherical Roller Bearings
	400	108	22244CAME4	K	Spherical Roller Bearings
	400	108	22244CAMKE4	K1	Spherical Roller Bearings
	400	108	22244EKMW33	K1	Spherical Roller Bearings
	400	108	22244EMW33	K	Spherical Roller Bearings
	400	144	23244CAME4	K	Spherical Roller Bearings
	400	144	23244CAMKE4	K1	Spherical Roller Bearings

Selection by Dimensions (Metric)

Bore Diameter 220 mm

Bore Diameter	OD	Width	Part Number	Type	Bearing Type
220	400	144	23244CE4	K	Spherical Roller Bearings
	400	144	23244CKE4	K1	Spherical Roller Bearings
	400	144	23244EKMW33	K1	Spherical Roller Bearings
	400	144	23244EMW33	K	Spherical Roller Bearings
	400	65	6244M	B	Single Row Radial Ball Bearings
	400	65	NJ244M	H1	Cylindrical Roller Bearings
	400	65	NU244M	H2	Cylindrical Roller Bearings
	420	122	29444M	O	Spherical Roller Bearings
	460	145	22344CAME4	K	Spherical Roller Bearings
	460	145	22344CAMKE4	K1	Spherical Roller Bearings
	460	145	22344EMW33	K	Spherical Roller Bearings

Selection by Dimensions (Inch)

Bore Diameter 1/8 – 5/8 Inch

Bore Diameter	OD	Width	Part Number	Type	Bearing Type
1/8	3/8	5/32	KLNJ1/8Y	B	Single Row Radial Ball Bearings
	3/8	5/32	R2ZZ	B1	Single Row Radial Ball Bearings
3/16	1/2	0,196	R3A-ZZ	B1	Single Row Radial Ball Bearings
	1/2	5/32	KLNJ3/16Y	B	Single Row Radial Ball Bearings
	1/2	5/32	R3	B	Single Row Radial Ball Bearings
	1/2	5/32	R3	B	Single Row Radial Ball Bearings
	1/2	5/32	R3ZZ	B1	Single Row Radial Ball Bearings
1/4	3/4	7/32	KLNJ1/4Y	B	Single Row Radial Ball Bearings
	3/4	7/32	R4ATNH	B	Single Row Radial Ball Bearings
	3/4	7/32	KLNJ1/4-2RSY	B2	Single Row Radial Ball Bearings
	3/4	7/32	KLNJ1/4-ZZY	B1	Single Row Radial Ball Bearings
	3/4	7/32	R4A-ZZ	B1	Single Row Radial Ball Bearings
	5/8	0,196	R4-2RS	B2	Single Row Radial Ball Bearings
	5/8	0,196	R4-ZZ	B1	Single Row Radial Ball Bearings
	5/8	0,196	R4TNH	B	Single Row Radial Ball Bearings
3/8	7/8	7/32	KLNJ3/8Y	B	Single Row Radial Ball Bearings
	7/8	7/32	R6	B	Single Row Radial Ball Bearings
	7/8	7/32	KLNJ3/8-2RSY	B2	Single Row Radial Ball Bearings
	7/8	7/32	KLNJ3/8-ZZY	B1	Single Row Radial Ball Bearings
	7/8	7/32	R6VV	B6	Single Row Radial Ball Bearings
	7/8	7/32	R6Z	B1	Single Row Radial Ball Bearings
	7/8	7/32	R6ZZ	B1	Single Row Radial Ball Bearings
1/2	1 1/8	1/4	KLNJ1/2Y	B	Single Row Radial Ball Bearings
	1 1/8	1/4	R8	B	Single Row Radial Ball Bearings
	1 1/8	5/16	KLNJ1/2-2RSY	B2	Single Row Radial Ball Bearings
	1 1/8	5/16	KLNJ1/2-ZZY	B1	Single Row Radial Ball Bearings
	1 1/8	5/16	R8DD	B2	Single Row Radial Ball Bearings
	1 1/8	5/16	R8ZZ	B1	Single Row Radial Ball Bearings
1 1/4	1 3/4	3/8	LJ1/2-2RSY	B2	Single Row Radial Ball Bearings
	1 3/4	3/8	LJ1/2-ZZY	B1	Single Row Radial Ball Bearings
	1 3/4	3/8	LJ1/2Y	B	Single Row Radial Ball Bearings
	1 3/4	3/8	LJT1/2M	D	Single Row Angular Contact Ball Bearings
	1 3/4	3/8	LRJ1/2M	H	Cylindrical Roller Bearings
	1 3/4	3/8	LRJA1/2M	H4	Cylindrical Roller Bearings
	1 3/4	3/8	RLS4	B	Single Row Radial Ball Bearings
	1 3/4	3/8	RLS4ZZ	B1	Single Row Radial Ball Bearings
1 1/2	1 7/8	5/8	MJ1 1/2	B	Single Row Radial Ball Bearings
5/8	1 1/4	5/8	MJ5/8-2RSJ	B2	Single Row Radial Ball Bearings
	1 1/4	5/8	MJ5/8-ZZJ	B1	Single Row Radial Ball Bearings
	1 1/4	5/8	MJ5/8J	B	Single Row Radial Ball Bearings
	1 1/4	5/8	MJT5/8M	D	Single Row Angular Contact Ball Bearings
	1 1/4	5/8	NMJ5/8M	G	Double Row Self Aligning Ball Bearings
	1 1/4	5/8	RMS5	B	Single Row Radial Ball Bearings
1 3/4	1 3/8	11/32	KLNJ3/4-2RSY	B2	Single Row Radial Ball Bearings
	1 3/8	11/32	KLNJ3/4-ZZY	B1	Single Row Radial Ball Bearings
	1 3/8	11/32	R10DDU	B2	Single Row Radial Ball Bearings
	1 3/8	11/32	R10ZZ	B1	Single Row Radial Ball Bearings
	1 3/8	7/32	KLNJ3/4Y	B	Single Row Radial Ball Bearings
	1 3/8	7/32	R10	B	Single Row Radial Ball Bearings
1 7/8	1 5/8	7/16	LJ3/4-2RSJ	B2	Single Row Radial Ball Bearings
	1 5/8	7/16	LJ3/4-ZZJ	B1	Single Row Radial Ball Bearings
	1 5/8	7/16	LJ3/4J	B	Single Row Radial Ball Bearings
	1 5/8	7/16	LJT3/4M	D	Single Row Angular Contact Ball Bearings
	1 5/8	7/16	LLR3/4J	H2	Cylindrical Roller Bearings
	1 5/8	7/16	LRJ3/4J	H	Cylindrical Roller Bearings
	1 5/8	7/16	LRJA3/4J	H4	Cylindrical Roller Bearings
	1 5/8	7/16	RLS5	B	Single Row Radial Ball Bearings

Selection by Dimensions (Inch)

Bore Diameter $\frac{5}{8}$ – 1 Inch

Bore Diameter	OD	Width	Part Number	Type	Bearing Type
$\frac{5}{8}$	$\frac{19}{16}$	$\frac{7}{16}$	RLS5DDU	B2	Single Row Radial Ball Bearings
	$\frac{19}{16}$	$\frac{7}{16}$	RLS5ZZ	B1	Single Row Radial Ball Bearings
$\frac{3}{4}$	$\frac{15}{8}$	$\frac{5}{16}$	KLNJ $\frac{3}{4}$ J	B	Single Row Radial Ball Bearings
	$\frac{15}{8}$	$\frac{5}{16}$	R12	B	Single Row Radial Ball Bearings
	$\frac{15}{8}$	$\frac{7}{16}$	KLNJ $\frac{3}{4}$ -2ZJ	B1	Single Row Radial Ball Bearings
	$\frac{15}{8}$	$\frac{7}{16}$	R12DDU	B2	Single Row Radial Ball Bearings
	$\frac{15}{8}$	$\frac{7}{16}$	R12ZZ	B1	Single Row Radial Ball Bearings
	$\frac{17}{8}$	$\frac{9}{16}$	LJ $\frac{3}{4}$ -2RSJ	B2	Single Row Radial Ball Bearings
	$\frac{17}{8}$	$\frac{9}{16}$	LJ $\frac{3}{4}$ -2ZJ	B1	Single Row Radial Ball Bearings
	$\frac{17}{8}$	$\frac{9}{16}$	LJ $\frac{3}{4}$ J	B	Single Row Radial Ball Bearings
	$\frac{17}{8}$	$\frac{9}{16}$	LJT $\frac{3}{4}$ M	D	Single Row Angular Contact Ball Bearings
	$\frac{17}{8}$	$\frac{9}{16}$	LLRJ $\frac{3}{4}$ J	H2	Cylindrical Roller Bearings
	$\frac{17}{8}$	$\frac{9}{16}$	LRJ $\frac{3}{4}$ J	H	Cylindrical Roller Bearings
	$\frac{17}{8}$	$\frac{9}{16}$	LRJA $\frac{3}{4}$ J	H4	Cylindrical Roller Bearings
	$\frac{17}{8}$	$\frac{9}{16}$	RLS6	B	Single Row Radial Ball Bearings
	$\frac{17}{8}$	$\frac{9}{16}$	RLS6ZZ	B1	Single Row Radial Ball Bearings
	2	$\frac{11}{16}$	MJ $\frac{3}{4}$ -2RSJ	B2	Single Row Radial Ball Bearings
	2	$\frac{11}{16}$	MJ $\frac{3}{4}$ -2ZJ	B1	Single Row Radial Ball Bearings
	2	$\frac{11}{16}$	MJ $\frac{3}{4}$ J	B	Single Row Radial Ball Bearings
	2	$\frac{11}{16}$	MJT $\frac{3}{4}$ M	D	Single Row Angular Contact Ball Bearings
	2	$\frac{11}{16}$	MMRJ $\frac{3}{4}$ J	H2	Cylindrical Roller Bearings
	2	$\frac{11}{16}$	RMS6	B	Single Row Radial Ball Bearings
	2	$\frac{11}{16}$	RMS6DDU	B2	Single Row Radial Ball Bearings
$\frac{7}{8}$	$\frac{17}{8}$	$\frac{1}{2}$	KLNJ $\frac{7}{8}$ -2ZJ	B1	Single Row Radial Ball Bearings
	$\frac{17}{8}$	$\frac{1}{2}$	R14ZZ	B1	Single Row Radial Ball Bearings
	$\frac{17}{8}$	$\frac{3}{8}$	KLNJ $\frac{7}{8}$ J	B	Single Row Radial Ball Bearings
	$\frac{17}{8}$	$\frac{3}{8}$	R14	B	Single Row Radial Ball Bearings
	2	$\frac{9}{16}$	LJ $\frac{7}{8}$ -2RSJ	B2	Single Row Radial Ball Bearings
	2	$\frac{9}{16}$	LJ $\frac{7}{8}$ -2ZJ	B1	Single Row Radial Ball Bearings
	2	$\frac{9}{16}$	LJ $\frac{7}{8}$ J	B	Single Row Radial Ball Bearings
	2	$\frac{9}{16}$	LJT $\frac{7}{8}$ M	D	Single Row Angular Contact Ball Bearings
	2	$\frac{9}{16}$	LLRJ $\frac{7}{8}$ J	H2	Cylindrical Roller Bearings
	2	$\frac{9}{16}$	LRJ $\frac{7}{8}$ J	H	Cylindrical Roller Bearings
	2	$\frac{9}{16}$	LRJA $\frac{7}{8}$ J	H4	Cylindrical Roller Bearings
	2	$\frac{9}{16}$	RLS7	B	Single Row Radial Ball Bearings
2	$\frac{9}{16}$	RLS7ZZ	B1	Single Row Radial Ball Bearings	
	$2\frac{1}{4}$	$\frac{11}{16}$	MJ $\frac{7}{8}$ -2RSJ	B2	Single Row Radial Ball Bearings
	$2\frac{1}{4}$	$\frac{11}{16}$	MJ $\frac{7}{8}$ J	B	Single Row Radial Ball Bearings
	$2\frac{1}{4}$	$\frac{11}{16}$	MJT $\frac{7}{8}$ M	D	Single Row Angular Contact Ball Bearings
	$2\frac{1}{4}$	$\frac{11}{16}$	MMRJ $\frac{7}{8}$ J	H2	Cylindrical Roller Bearings
	$2\frac{1}{4}$	$\frac{11}{16}$	MRJ $\frac{7}{8}$ J	H	Cylindrical Roller Bearings
	$2\frac{1}{4}$	$\frac{11}{16}$	MRJA $\frac{7}{8}$ J	H4	Cylindrical Roller Bearings
	$2\frac{1}{4}$	$\frac{11}{16}$	NMJ $\frac{7}{8}$ M	G	Double Row Self Aligning Ball Bearings
	$2\frac{1}{4}$	$\frac{11}{16}$	RMS7	B	Single Row Radial Ball Bearings
1	2	$\frac{1}{2}$	KLNJ1-2RSJ	B2	Single Row Radial Ball Bearings
	2	$\frac{1}{2}$	KLNJ1-2ZJ	B1	Single Row Radial Ball Bearings
	2	$\frac{1}{2}$	R16DDU	B2	Single Row Radial Ball Bearings
	2	$\frac{1}{2}$	R16ZZ	B1	Single Row Radial Ball Bearings
	2	$\frac{3}{8}$	KLNJ1J	B	Single Row Radial Ball Bearings
	2	$\frac{3}{8}$	R16	B	Single Row Radial Ball Bearings
	$2\frac{1}{2}$	$\frac{3}{4}$	MJT1M	D	Single Row Angular Contact Ball Bearings
	$2\frac{1}{2}$	$\frac{3}{4}$	MJ1J	B	Single Row Radial Ball Bearings
	$2\frac{1}{2}$	$\frac{3}{4}$	MMRJ1J	H2	Cylindrical Roller Bearings
	$2\frac{1}{2}$	$\frac{3}{4}$	MMRJN1M	H2	Cylindrical Roller Bearings
	$2\frac{1}{2}$	$\frac{3}{4}$	MRJ1J	H	Cylindrical Roller Bearings
	$2\frac{1}{2}$	$\frac{3}{4}$	MRJA1J	H4	Cylindrical Roller Bearings
	$2\frac{1}{2}$	$\frac{3}{4}$	NMJ1M	G	Double Row Self Aligning Ball Bearings
	$2\frac{1}{2}$	$\frac{3}{4}$	RMS8	B	Single Row Radial Ball Bearings
	$2\frac{1}{2}$	$\frac{7}{8}$	MJ1-2RSJ	B2	Single Row Radial Ball Bearings

Selection by Dimensions (Inch)

Bore Diameter 1 – 1³/₈ Inch

Bore Diameter	OD	Width	Part Number	Type	Bearing Type	
1	2½	¾	MJ1-ZZJ	B1	Single Row Radial Ball Bearings	
	2¼	⅝	LJ1-2RSJ	B2	Single Row Radial Ball Bearings	
	2¼	⅝	LJ1-ZZJ	B1	Single Row Radial Ball Bearings	
	2¼	⅝	LJ1J	B	Single Row Radial Ball Bearings	
	2¼	⅝	LJT1M	D	Single Row Angular Contact Ball Bearings	
	2¼	⅝	LRJ1J	H	Cylindrical Roller Bearings	
	2¼	⅝	LRJA1J	H4	Cylindrical Roller Bearings	
	2¼	⅝	NLJ1TN	G	Double Row Self Aligning Ball Bearings	
1½	2½	⅝	RLS8	B	Single Row Radial Ball Bearings	
	2½	⅝	LJ1½-2RSJ	B2	Single Row Radial Ball Bearings	
	2½	⅝	LJ1½-ZZJ	B1	Single Row Radial Ball Bearings	
	2½	⅝	LJ1½J	B	Single Row Radial Ball Bearings	
	2½	⅝	LJT1½M	D	Single Row Angular Contact Ball Bearings	
	2½	⅝	LLRJ1½J	H2	Cylindrical Roller Bearings	
	2½	⅝	LRJ1½J	H	Cylindrical Roller Bearings	
	2½	⅝	LRJA1½J	H4	Cylindrical Roller Bearings	
2	2½	⅝	NLJ1½TN	G	Double Row Self Aligning Ball Bearings	
	2½	⅝	RLS9	B	Single Row Radial Ball Bearings	
	2½	½	R18ZZ	B1	Single Row Radial Ball Bearings	
2¼	2½	⅝	KLNJ1½J	B	Single Row Radial Ball Bearings	
	2½	⅝	R18	B	Single Row Radial Ball Bearings	
	2¾	⅞	MJ1½J	B	Single Row Radial Ball Bearings	
	2¾	⅞	MJT1½M	D	Single Row Angular Contact Ball Bearings	
	2¾	⅞	MMRJ1½J	H2	Cylindrical Roller Bearings	
2½	2¾	⅞	MRJ1½J	H	Cylindrical Roller Bearings	
	2¾	⅞	MRJA1½J	H4	Cylindrical Roller Bearings	
	2¾	⅞	RMS9	B	Single Row Radial Ball Bearings	
	1¼	2¼	½	KLNJ1¼-ZZJ	B1	Single Row Radial Ball Bearings
		2¼	½	R20ZZ	B1	Single Row Radial Ball Bearings
2¼		⅝	KLNJ1¼J	B	Single Row Radial Ball Bearings	
2¼		⅝	R20	B	Single Row Radial Ball Bearings	
2	2¾	⅞	LJ1¼-2RSJ	B2	Single Row Radial Ball Bearings	
	2¾	⅞	LJ1¼-ZZJ	B1	Single Row Radial Ball Bearings	
	2¾	⅞	LJ1¼J	B	Single Row Radial Ball Bearings	
	2¾	⅞	LJT1¼M	D	Single Row Angular Contact Ball Bearings	
	2¾	⅞	LLRJ1¼J	H2	Cylindrical Roller Bearings	
	2¾	⅞	LRJ1¼J	H	Cylindrical Roller Bearings	
	2¾	⅞	LRJA1¼J	H4	Cylindrical Roller Bearings	
	2¾	⅞	NLJ1¼TN	G	Double Row Self Aligning Ball Bearings	
	2¾	⅞	RLS10	B	Single Row Radial Ball Bearings	
2½	3	0,875	MJT1¼M	D	Single Row Angular Contact Ball Bearings	
	3	⅞	MJ1¼-2RSJ	B2	Single Row Radial Ball Bearings	
	3	⅞	MJ1¼-ZZJ	B1	Single Row Radial Ball Bearings	
	3	⅞	MJ1¼J	B	Single Row Radial Ball Bearings	
	3	⅞	MJ1¼NRJ	B3	Single Row Radial Ball Bearings	
	3	⅞	MMRJ1¼J	H2	Cylindrical Roller Bearings	
	3	⅞	MRJ1¼J	H	Cylindrical Roller Bearings	
	3	⅞	MRJA1¼J	H4	Cylindrical Roller Bearings	
	3	⅞	MRJA1¼V	H4	Cylindrical Roller Bearings	
	3	⅞	NMJ1¼M	G	Double Row Self Aligning Ball Bearings	
3	⅞	RMS10	B	Single Row Radial Ball Bearings		
1½	2½	⅞	KLNJ1¾J	B	Single Row Radial Ball Bearings	
	2¾	⅞	XLJ1¾J	B	Single Row Radial Ball Bearings	
2	3	⅞	LJ1¾-2RSJ	B2	Single Row Radial Ball Bearings	
	3	⅞	LJ1¾-ZZJ	B1	Single Row Radial Ball Bearings	
	3	⅞	LJ1¾J	B	Single Row Radial Ball Bearings	
	3	⅞	LJT1¾M	D	Single Row Angular Contact Ball Bearings	
	3	⅞	LLRJ1¾J	H2	Cylindrical Roller Bearings	

Selection by Dimensions (Inch)

Bore Diameter 1³/₈ – 1³/₄ Inch

Bore Diameter	OD	Width	Part Number	Type	Bearing Type
1 ³ / ₈	3	7/16	LRJ1 ³ / ₈ J	H	Cylindrical Roller Bearings
	3	7/16	LRJA1 ³ / ₈ J	H4	Cylindrical Roller Bearings
	3	7/16	NLJ1 ³ / ₈ M	G	Double Row Self Aligning Ball Bearings
	3	7/16	RLS11	B	Single Row Radial Ball Bearings
1 ³ / ₈	3 ¹ / ₂	0,875	MJT1 ³ / ₈ M	D	Single Row Angular Contact Ball Bearings
	3 ¹ / ₂	7/8	MJ1 ³ / ₈ -2ZJ	B1	Single Row Radial Ball Bearings
	3 ¹ / ₂	7/8	MJ1 ³ / ₈ J	B	Single Row Radial Ball Bearings
	3 ¹ / ₂	7/8	MRJ1 ³ / ₈ J	H	Cylindrical Roller Bearings
	3 ¹ / ₂	7/8	MRJA1 ³ / ₈ J	H4	Cylindrical Roller Bearings
	3 ¹ / ₂	7/8	RMS11	B	Single Row Radial Ball Bearings
1 ¹ / ₂	2 ¹ / ₁₆	9/16	XLJ1 ¹ / ₂ Y	B	Single Row Radial Ball Bearings
	2 ¹ / ₁₆	9/16	XLRJ1 ¹ / ₂ M	H	Cylindrical Roller Bearings
1 ¹ / ₂	2 ⁵ / ₈	7/16	KLNJ1 ¹ / ₂ J	B	Single Row Radial Ball Bearings
	3 ³ / ₄	3/4	LJ1 ¹ / ₂ -2RSJ	B2	Single Row Radial Ball Bearings
	3 ³ / ₄	3/4	LJ1 ¹ / ₂ -2ZJ	B1	Single Row Radial Ball Bearings
	3 ³ / ₄	3/4	LJ1 ¹ / ₂ J	B	Single Row Radial Ball Bearings
	3 ³ / ₄	3/4	LJT1 ¹ / ₂ M	D	Single Row Angular Contact Ball Bearings
	3 ³ / ₄	3/4	LLRJ1 ¹ / ₂ J	H2	Cylindrical Roller Bearings
	3 ³ / ₄	3/4	LRJ1 ¹ / ₂ J	H	Cylindrical Roller Bearings
	3 ³ / ₄	3/4	LRJ1 ¹ / ₂ M	H	Cylindrical Roller Bearings
	3 ³ / ₄	3/4	LRJA1 ¹ / ₂ J	H4	Cylindrical Roller Bearings
	3 ³ / ₄	3/4	RLS12	B	Single Row Radial Ball Bearings
1 ¹ / ₂	3 ³ / ₄	5/16	MJ1 ¹ / ₂ J	B	Single Row Radial Ball Bearings
	3 ³ / ₄	5/16	MJT1 ¹ / ₂ M	D	Single Row Angular Contact Ball Bearings
	3 ³ / ₄	5/16	MMRJ1 ¹ / ₂ J	H2	Cylindrical Roller Bearings
	3 ³ / ₄	5/16	MRJ1 ¹ / ₂ J	H	Cylindrical Roller Bearings
	3 ³ / ₄	5/16	MRJA1 ¹ / ₂ J	H4	Cylindrical Roller Bearings
	3 ³ / ₄	5/16	NMJ1 ¹ / ₂ M	G	Double Row Self Aligning Ball Bearings
	3 ³ / ₄	5/16	RMS12	B	Single Row Radial Ball Bearings
1 ¹ / ₂	2 ⁷ / ₈	9/16	XLJ1 ¹ / ₂ M	B	Single Row Radial Ball Bearings
	3 ¹ / ₂	3/4	LJ1 ¹ / ₂ J	B	Single Row Radial Ball Bearings
	3 ¹ / ₂	3/4	LJT1 ¹ / ₂ M	D	Single Row Angular Contact Ball Bearings
	3 ¹ / ₂	3/4	LRJ1 ¹ / ₂ J	H	Cylindrical Roller Bearings
	3 ¹ / ₂	3/4	LRJA1 ¹ / ₂ J	H4	Cylindrical Roller Bearings
	3 ¹ / ₂	3/4	NLJ1 ¹ / ₂ TN	G	Double Row Self Aligning Ball Bearings
	3 ¹ / ₂	3/4	RLS13	B	Single Row Radial Ball Bearings
1 ¹ / ₂	4	5/16	MJ1 ¹ / ₂ J	B	Single Row Radial Ball Bearings
	4	5/16	MJT1 ¹ / ₂ M	D	Single Row Angular Contact Ball Bearings
	4	5/16	MRJ1 ¹ / ₂ M	H	Cylindrical Roller Bearings
	4	5/16	MRJA1 ¹ / ₂ M	H4	Cylindrical Roller Bearings
	4	5/16	RMS13	B	Single Row Radial Ball Bearings
1 ³ / ₄	3	9/16	XLJ1 ³ / ₄ J	B	Single Row Radial Ball Bearings
	3	9/16	XLRJ1 ³ / ₄ M	H	Cylindrical Roller Bearings
1 ³ / ₄	3 ³ / ₄	5/16	LJ1 ³ / ₄ -2ZJ	B1	Single Row Radial Ball Bearings
	3 ³ / ₄	5/16	LJ1 ³ / ₄ J	B	Single Row Radial Ball Bearings
	3 ³ / ₄	5/16	LJT1 ³ / ₄ M	D	Single Row Angular Contact Ball Bearings
	3 ³ / ₄	5/16	LRJ1 ³ / ₄ J	H	Cylindrical Roller Bearings
	3 ³ / ₄	5/16	LRJA1 ³ / ₄ J	H4	Cylindrical Roller Bearings
	3 ³ / ₄	5/16	NLJ1 ³ / ₄ TN	G	Double Row Self Aligning Ball Bearings
	3 ³ / ₄	5/16	RLS14	B	Single Row Radial Ball Bearings
1 ³ / ₄	4 ¹ / ₄	1 ¹ / ₁₆	MJ1 ³ / ₄ J	B	Single Row Radial Ball Bearings
	4 ¹ / ₄	1 ¹ / ₁₆	MJT1 ³ / ₄ M	D	Single Row Angular Contact Ball Bearings
	4 ¹ / ₄	1 ¹ / ₁₆	MRJ1 ³ / ₄ J	H	Cylindrical Roller Bearings
	4 ¹ / ₄	1 ¹ / ₁₆	MRJA1 ³ / ₄ J	H4	Cylindrical Roller Bearings
	4 ¹ / ₄	1 ¹ / ₁₆	NMJ1 ³ / ₄ M	G	Double Row Self Aligning Ball Bearings
	4 ¹ / ₄	1 ¹ / ₁₆	RMS14	B	Single Row Radial Ball Bearings

Selection by Dimensions (Inch)

Bore Diameter 1⁷/₈ – 2³/₄ Inch

Bore Diameter	OD	Width	Part Number	Type	Bearing Type
1 ⁷ / ₈	3 ³ / ₈	5/8	XLJ1 ⁷ / ₈ J	B	Single Row Radial Ball Bearings
	4	3/4	LJ1 ⁷ / ₈ J	B	Single Row Radial Ball Bearings
	4	3/4	LJT1 ⁷ / ₈ M	D	Single Row Angular Contact Ball Bearings
	4	3/4	LRJ1 ⁷ / ₈ J	H	Cylindrical Roller Bearings
	4	3/4	RLS15	B	Single Row Radial Ball Bearings
	4 ¹ / ₂	1 ¹ / ₈	MJ1 ⁷ / ₈ J	B	Single Row Radial Ball Bearings
	4 ¹ / ₂	1 ¹ / ₈	MJT1 ⁷ / ₈ M	D	Single Row Angular Contact Ball Bearings
	4 ¹ / ₂	1 ¹ / ₈	MRJ1 ⁷ / ₈ J	H	Cylindrical Roller Bearings
	4 ¹ / ₂	1 ¹ / ₈	NMJ1 ⁷ / ₈ M	G	Double Row Self Aligning Ball Bearings
	4 ¹ / ₂	1 ¹ / ₈	RMS15	B	Single Row Radial Ball Bearings
2	3 ⁵ / ₈	5/8	XLRJ2M	H	Cylindrical Roller Bearings
	3 ⁵ / ₈	5/8	XLJ2J	B	Single Row Radial Ball Bearings
	4	3/4	LJ2J	B	Single Row Radial Ball Bearings
	4	3/4	LJT2M	D	Single Row Angular Contact Ball Bearings
	4	3/4	LRJ2J	H	Cylindrical Roller Bearings
	4	3/4	LRJA2J	H4	Cylindrical Roller Bearings
	4	3/4	RLS16	B	Single Row Radial Ball Bearings
	4 ¹ / ₂	1 ¹ / ₈	MJ2J	B	Single Row Radial Ball Bearings
	4 ¹ / ₂	1 ¹ / ₈	MJT2M	D	Single Row Angular Contact Ball Bearings
	4 ¹ / ₂	1 ¹ / ₈	MMRJ2J	H2	Cylindrical Roller Bearings
	4 ¹ / ₂	1 ¹ / ₈	MRJ2J	H	Cylindrical Roller Bearings
	4 ¹ / ₂	1 ¹ / ₈	MRJA2J	H4	Cylindrical Roller Bearings
	4 ¹ / ₂	1 ¹ / ₈	RMS16	B	Single Row Radial Ball Bearings
2 ¹ / ₄	3 ³ / ₈	5/8	XLJ2 ¹ / ₄ J	B	Single Row Radial Ball Bearings
	3 ³ / ₈	5/8	XLRJ2 ¹ / ₄ M	H	Cylindrical Roller Bearings
	4 ¹ / ₂	7/8	LJ2 ¹ / ₄ J	B	Single Row Radial Ball Bearings
	4 ¹ / ₂	7/8	LJT2 ¹ / ₄ M	D	Single Row Angular Contact Ball Bearings
	4 ¹ / ₂	7/8	LLRJ2 ¹ / ₄ M	H2	Cylindrical Roller Bearings
	4 ¹ / ₂	7/8	LRJ2 ¹ / ₄ J	H	Cylindrical Roller Bearings
	4 ¹ / ₂	7/8	LRJA2 ¹ / ₄ J	H4	Cylindrical Roller Bearings
	4 ¹ / ₂	7/8	RLS18	B	Single Row Radial Ball Bearings
	5	1 ¹ / ₄	MJ2 ¹ / ₄ J	B	Single Row Radial Ball Bearings
	5	1 ¹ / ₄	MJT2 ¹ / ₄ M	D	Single Row Angular Contact Ball Bearings
	5	1 ¹ / ₄	MRJ2 ¹ / ₄ J	H	Cylindrical Roller Bearings
	5	1 ¹ / ₄	MRJA2 ¹ / ₄ J	H4	Cylindrical Roller Bearings
	5	1 ¹ / ₄	NMJ2 ¹ / ₄ M	G	Double Row Self Aligning Ball Bearings
	5	1 ¹ / ₄	QJM2 ¹ / ₄ M	P2	Duplex Ball Bearings
	5	1 ¹ / ₄	RMS18	B	Single Row Radial Ball Bearings
2 ³ / ₈	3 ¹ / ₄	1 ¹ / ₈	XLJ2 ³ / ₈ J	B	Single Row Radial Ball Bearings
2 ¹ / ₂	3 ⁷ / ₈	1 ¹ / ₈	XLJ2 ¹ / ₂ J	B	Single Row Radial Ball Bearings
	3 ⁷ / ₈	1 ¹ / ₈	XLRJ2 ¹ / ₂ M	H	Cylindrical Roller Bearings
	5	1 ³ / ₈	LJ2 ¹ / ₂ J	B	Single Row Radial Ball Bearings
	5	1 ³ / ₈	LJT2 ¹ / ₂ M	D	Single Row Angular Contact Ball Bearings
	5	1 ³ / ₈	LRJ2 ¹ / ₂ J	H	Cylindrical Roller Bearings
	5	1 ³ / ₈	LRJA2 ¹ / ₂ J	H4	Cylindrical Roller Bearings
	5 ¹ / ₂	1 ¹ / ₄	MJ2 ¹ / ₂ J	B	Single Row Radial Ball Bearings
	5 ¹ / ₂	1 ¹ / ₄	MJT2 ¹ / ₂ M	D	Single Row Angular Contact Ball Bearings
	5 ¹ / ₂	1 ¹ / ₄	MRJ2 ¹ / ₂ EM	H	Cylindrical Roller Bearings
	5 ¹ / ₂	1 ¹ / ₄	MRJ2 ¹ / ₂ J	H	Cylindrical Roller Bearings
	5 ¹ / ₂	1 ¹ / ₄	MRJA2 ¹ / ₂ J	H4	Cylindrical Roller Bearings
	5 ¹ / ₂	1 ¹ / ₄	NMJ2 ¹ / ₂ M	G	Double Row Self Aligning Ball Bearings
	5 ¹ / ₂	1 ¹ / ₄	RMS20	B	Single Row Radial Ball Bearings
2 ³ / ₄	4 ¹ / ₈	1 ¹ / ₈	XLJ2 ³ / ₄ M	B	Single Row Radial Ball Bearings
	4 ¹ / ₈	1 ¹ / ₈	XLRJ2 ³ / ₄ M	H	Cylindrical Roller Bearings
	5 ¹ / ₄	1 ¹ / ₈	LJ2 ³ / ₄ J	B	Single Row Radial Ball Bearings
	5 ¹ / ₄	1 ¹ / ₈	LJT2 ³ / ₄ M	D	Single Row Angular Contact Ball Bearings

Selection by Dimensions (Inch)

Bore Diameter 2³/₄ – 4 Inch

Bore Diameter	OD	Width	Part Number	Type	Bearing Type
2 ³ / ₄	5 ¹ / ₄	8 ¹ / ₄	LRJ2 ³ / ₄ J	H	Cylindrical Roller Bearings
	5 ¹ / ₄	8 ¹ / ₄	LRJA2 ³ / ₄ J	H4	Cylindrical Roller Bearings
	6 ¹ / ₄	1 ¹ / ₈	MJ2 ³ / ₄ J	B	Single Row Radial Ball Bearings
	6 ¹ / ₄	1 ¹ / ₈	MJT2 ³ / ₄ M	D	Single Row Angular Contact Ball Bearings
	6 ¹ / ₄	1 ¹ / ₈	MRJ2 ³ / ₄ EM	H	Cylindrical Roller Bearings
	6 ¹ / ₄	1 ¹ / ₈	MRJA2 ³ / ₄ EM	H4	Cylindrical Roller Bearings
	6 ¹ / ₄	1 ¹ / ₈	RMS22	B	Single Row Radial Ball Bearings
3	4 ¹ / ₂	3 ¹ / ₄	XLJ3J	B	Single Row Radial Ball Bearings
	5 ¹ / ₄	1 ¹ / ₁₆	LJ3J	B	Single Row Radial Ball Bearings
	5 ¹ / ₄	1 ¹ / ₁₆	LJT3M	D	Single Row Angular Contact Ball Bearings
	5 ¹ / ₄	1 ¹ / ₁₆	LRJ3J	H	Cylindrical Roller Bearings
	5 ¹ / ₄	1 ¹ / ₁₆	LRJA3J	H4	Cylindrical Roller Bearings
	5 ¹ / ₄	1 ¹ / ₁₆	RLS24	B	Single Row Radial Ball Bearings
	7	1 ⁹ / ₁₆	MJ3J	B	Single Row Radial Ball Bearings
	7	1 ⁹ / ₁₆	MJT3M	D	Single Row Angular Contact Ball Bearings
	7	1 ⁹ / ₁₆	MRJ3EM	H	Cylindrical Roller Bearings
	7	1 ⁹ / ₁₆	MRJ3J	H	Cylindrical Roller Bearings
	7	1 ⁹ / ₁₆	MRJA3J	H4	Cylindrical Roller Bearings
	7	1 ⁹ / ₁₆	NMJ3M	G	Double Row Self Aligning Ball Bearings
7	1 ⁹ / ₁₆	RMS24	B	Single Row Radial Ball Bearings	
3 ¹ / ₄	4 ³ / ₄	3 ¹ / ₄	XLJ3 ¹ / ₄ M	B	Single Row Radial Ball Bearings
	6	1 ¹ / ₁₆	LJ3 ¹ / ₄ J	B	Single Row Radial Ball Bearings
	6	1 ¹ / ₁₆	LJT3 ¹ / ₄ M	D	Single Row Angular Contact Ball Bearings
	6	1 ¹ / ₁₆	LRJ3 ¹ / ₄ M	H	Cylindrical Roller Bearings
	6	1 ¹ / ₁₆	LRJA3 ¹ / ₄ M	H4	Cylindrical Roller Bearings
	7 ¹ / ₂	1 ⁹ / ₁₆	MJ3 ¹ / ₄ J	B	Single Row Radial Ball Bearings
	7 ¹ / ₂	1 ⁹ / ₁₆	MJT3 ¹ / ₄ M	D	Single Row Angular Contact Ball Bearings
	7 ¹ / ₂	1 ⁹ / ₁₆	MRJ3 ¹ / ₄ J	H	Cylindrical Roller Bearings
	7 ¹ / ₂	1 ⁹ / ₁₆	MRJA3 ¹ / ₄ EM	H4	Cylindrical Roller Bearings
	7 ¹ / ₂	1 ⁹ / ₁₆	QJM3 ¹ / ₄ M	P2	Duplex Ball Bearings
3 ³ / ₈	7 ¹ / ₂	1 ⁹ / ₁₆	MJ3 ³ / ₈ J	B	Single Row Radial Ball Bearings
	7 ¹ / ₂	1 ⁹ / ₁₆	MRJ3 ³ / ₈ J	H	Cylindrical Roller Bearings
3 ¹ / ₂	5	3 ¹ / ₄	XLJ3 ¹ / ₂ J	B	Single Row Radial Ball Bearings
	5	3 ¹ / ₄	XLRJA3 ¹ / ₂ M	H4	Cylindrical Roller Bearings
	6 ¹ / ₂	1 ¹ / ₈	LJ3 ¹ / ₂ J	B	Single Row Radial Ball Bearings
	6 ¹ / ₂	1 ¹ / ₈	LJT3 ¹ / ₂ M	D	Single Row Angular Contact Ball Bearings
	6 ¹ / ₂	1 ¹ / ₈	LRJ3 ¹ / ₂ J	H	Cylindrical Roller Bearings
	6 ¹ / ₂	1 ¹ / ₈	LRJA3 ¹ / ₂ J	H4	Cylindrical Roller Bearings
	6 ¹ / ₂	1 ¹ / ₈	RLS28	B	Single Row Radial Ball Bearings
	8 ¹ / ₄	1 ³ / ₄	QJM3 ¹ / ₂ LOCM	P2	Duplex Ball Bearings
	8 ¹ / ₈	1 ³ / ₄	MJ3 ¹ / ₂ J	B	Single Row Radial Ball Bearings
	8 ¹ / ₈	1 ³ / ₄	MJT3 ¹ / ₂ M	D	Single Row Angular Contact Ball Bearings
	8 ¹ / ₈	1 ³ / ₄	MRJ3 ¹ / ₂ EM	H	Cylindrical Roller Bearings
	8 ¹ / ₈	1 ³ / ₄	QJM3 ¹ / ₂ M	P2	Duplex Ball Bearings
3 ³ / ₄	6 ³ / ₄	1 ¹ / ₈	LJ3 ³ / ₄ J	B	Single Row Radial Ball Bearings
	6 ³ / ₄	1 ¹ / ₈	LJT3 ³ / ₄ M	D	Single Row Angular Contact Ball Bearings
	6 ³ / ₄	1 ¹ / ₈	LRJ3 ³ / ₄ M	H	Cylindrical Roller Bearings
	6 ³ / ₄	1 ¹ / ₈	LRJA3 ³ / ₄ M	H4	Cylindrical Roller Bearings
	8 ¹ / ₄	1 ³ / ₄	MJ3 ³ / ₄ J	B	Single Row Radial Ball Bearings
	8 ¹ / ₄	1 ³ / ₄	MJT3 ³ / ₄ M	D	Single Row Angular Contact Ball Bearings
	8 ¹ / ₄	1 ³ / ₄	MRJ3 ³ / ₄ EM	H	Cylindrical Roller Bearings
	8 ¹ / ₄	1 ³ / ₄	MRJA3 ³ / ₄ EM	H4	Cylindrical Roller Bearings
	8 ¹ / ₄	1 ³ / ₄	QJM3 ³ / ₄ M	P2	Duplex Ball Bearings
4	5 ⁵ / ₈	7 ⁷ / ₈	XLJ4M	B	Single Row Radial Ball Bearings
	5 ⁵ / ₈	7 ⁷ / ₈	XLRJA4M	H4	Cylindrical Roller Bearings

Selection by Dimensions (Inch)

Bore Diameter 4 – 5³/₄ Inch

Bore Diameter	OD	Width	Part Number	Type	Bearing Type
4	7 ¹ / ₄	1 ¹ / ₄	LJ4J	B	Single Row Radial Ball Bearings
	7 ¹ / ₄	1 ¹ / ₄	LJT4M	D	Single Row Angular Contact Ball Bearings
	7 ¹ / ₄	1 ¹ / ₄	LRJ4M	H	Cylindrical Roller Bearings
	7 ¹ / ₄	1 ¹ / ₄	LRJA4M	H4	Cylindrical Roller Bearings
	8 ¹ / ₂	1 ³ / ₄	MJ4J	B	Single Row Radial Ball Bearings
	8 ¹ / ₂	1 ³ / ₄	MJT4M	D	Single Row Angular Contact Ball Bearings
	8 ¹ / ₂	1 ³ / ₄	MRJ4EM	H	Cylindrical Roller Bearings
4 ¹ / ₄	6	7 ⁷ / ₈	XLJ4 ¹ / ₄ J	B	Single Row Radial Ball Bearings
	6	7 ⁷ / ₈	XLRJ4 ¹ / ₄ M	H	Cylindrical Roller Bearings
	7 ¹ / ₂	1 ¹ / ₄	LJ4 ¹ / ₄ J	B	Single Row Radial Ball Bearings
	7 ¹ / ₂	1 ¹ / ₄	LJT4 ¹ / ₄ M	D	Single Row Angular Contact Ball Bearings
	7 ¹ / ₂	1 ¹ / ₄	LRJ4 ¹ / ₄ M	H	Cylindrical Roller Bearings
	7 ¹ / ₂	1 ¹ / ₄	LRJA4 ¹ / ₄ M	H4	Cylindrical Roller Bearings
	8 ³ / ₄	1 ³ / ₄	MJ4 ¹ / ₄ M	B	Single Row Radial Ball Bearings
	8 ³ / ₄	1 ³ / ₄	MJT4 ¹ / ₄ M	D	Single Row Angular Contact Ball Bearings
	8 ³ / ₄	1 ³ / ₄	MRJ4 ¹ / ₄ EM	H	Cylindrical Roller Bearings
	8 ³ / ₄	1 ³ / ₄	MRJA4 ¹ / ₄ EM	H4	Cylindrical Roller Bearings
4 ¹ / ₂	6 ¹ / ₄	7 ⁷ / ₈	XLJ4 ¹ / ₂ J	B	Single Row Radial Ball Bearings
	6 ¹ / ₄	7 ⁷ / ₈	XLRJ4 ¹ / ₂ M	H	Cylindrical Roller Bearings
	8	1 ⁵ / ₁₆	LJ4 ¹ / ₂ J	B	Single Row Radial Ball Bearings
	8	1 ⁵ / ₁₆	LJT4 ¹ / ₂ M	D	Single Row Angular Contact Ball Bearings
	8	1 ⁵ / ₁₆	LRJ4 ¹ / ₂ M	H	Cylindrical Roller Bearings
	8	1 ⁵ / ₁₆	LRJA4 ¹ / ₂ M	H4	Cylindrical Roller Bearings
	8	1 ⁵ / ₁₆	MJT4 ¹ / ₂ M	D	Single Row Angular Contact Ball Bearings
	9 ³ / ₈	2	MJ4 ¹ / ₂ J	B	Single Row Radial Ball Bearings
	9 ³ / ₈	2	MMRJ4 ¹ / ₂ EM	H2	Cylindrical Roller Bearings
	9 ³ / ₈	2	MRJ4 ¹ / ₂ EM	H	Cylindrical Roller Bearings
	9 ³ / ₈	2	MRJA4 ¹ / ₂ EM	H4	Cylindrical Roller Bearings
	9 ³ / ₈	2	QJM4 ¹ / ₂ M	P2	Duplex Ball Bearings
4 ³ / ₄	10	2	MJ4 ³ / ₄ J	B	Single Row Radial Ball Bearings
	10	2	MRJ4 ³ / ₄ EM	H	Cylindrical Roller Bearings
	6 ¹ / ₂	7 ⁷ / ₈	XLJ4 ³ / ₄ J	B	Single Row Radial Ball Bearings
	6 ¹ / ₂	7 ⁷ / ₈	XLRJ4 ³ / ₄ M	B	Single Row Radial Ball Bearings
	8 ³ / ₄	1 ⁵ / ₁₆	LJ4 ³ / ₄ M	B	Single Row Radial Ball Bearings
	8 ³ / ₄	1 ⁵ / ₁₆	LRJ4 ³ / ₄ M	H	Cylindrical Roller Bearings
5	10	2	MJ5J	B	Single Row Radial Ball Bearings
	10	2	MRJ5EM	H	Cylindrical Roller Bearings
	10	2	MRJA5EM	H4	Cylindrical Roller Bearings
	7	1	XLJ5J	B	Single Row Radial Ball Bearings
	7	1	XLJ5M	B	Single Row Radial Ball Bearings
	9	1 ¹ / ₈	LJ5J	B	Single Row Radial Ball Bearings
	9	1 ¹ / ₈	LJT5M	D	Single Row Angular Contact Ball Bearings
	9	1 ¹ / ₈	LRJ5M	H	Cylindrical Roller Bearings
	9	1 ¹ / ₈	LRJA5M	H4	Cylindrical Roller Bearings
5 ¹ / ₄	7 ¹ / ₄	1	XLJ5 ¹ / ₄ M	B	Single Row Radial Ball Bearings
	7 ¹ / ₄	1	XLRJ5 ¹ / ₄ M	H	Cylindrical Roller Bearings
5 ¹ / ₂	11	2	MMRJ5EM	H2	Cylindrical Roller Bearings
	11	2	MRJ5EM	H	Cylindrical Roller Bearings
	7 ¹ / ₂	1	XLJ5M	B	Single Row Radial Ball Bearings
	9 ¹ / ₂	1 ¹ / ₈	LJ5J	B	Single Row Radial Ball Bearings
	9 ¹ / ₂	1 ¹ / ₈	LJT5M	D	Single Row Angular Contact Ball Bearings
	9 ¹ / ₂	1 ¹ / ₈	LRJ5 ¹ / ₂ M	H	Cylindrical Roller Bearings
	9 ¹ / ₂	1 ¹ / ₈	LRJA5M	H4	Cylindrical Roller Bearings
5 ³ / ₄	7 ³ / ₄	1	XLJ5 ³ / ₄ M	B	Single Row Radial Ball Bearings

Selection by Dimensions (Inch)

Bore Diameter 6 – 57,15 Inch

Bore Diameter	OD	Width	Part Number	Type	Bearing Type
6	10½	1⅞	LJ6J	B	Single Row Radial Ball Bearings
	10½	1⅞	LJT6M	D	Single Row Angular Contact Ball Bearings
	10½	1⅞	LRJ6M	H	Cylindrical Roller Bearings
	10½	1⅞	LRJA6M	H4	Cylindrical Roller Bearings
	12	2¼	MRJ6EM	H	Cylindrical Roller Bearings
	8	1	XLJ6M	B	Single Row Radial Ball Bearings
6½	11	1⅞	LJ6½M	B	Single Row Radial Ball Bearings
	11	1⅞	LJT6½M	D	Single Row Angular Contact Ball Bearings
	11	1⅞	LRJ6½M	H	Cylindrical Roller Bearings
	11	1⅞	LRJA6½M	H4	Cylindrical Roller Bearings
	13	2½	MRJ6½EM	H	Cylindrical Roller Bearings
	13	2½	MRJA6½EM	H4	Cylindrical Roller Bearings
	8¾	1⅞	XLJ6½M	B	Single Row Radial Ball Bearings
	8¾	1⅞	XLRJ6½M	H	Cylindrical Roller Bearings
6¾	9	1⅞	XLJ6¾J	B	Single Row Radial Ball Bearings
7	12	1¾	LJ7M	B	Single Row Radial Ball Bearings
	12	1¾	LJT7M	D	Single Row Angular Contact Ball Bearings
	12	1¾	LRJ7M	H	Cylindrical Roller Bearings
	12	1¾	LRJA7M	H4	Cylindrical Roller Bearings
	9½	1¾	XLJ7M	B	Single Row Radial Ball Bearings
7½	10	1¾	XLJ7½M	B	Single Row Radial Ball Bearings
	12½	1¾	LJ7½M	B	Single Row Radial Ball Bearings
	12½	1¾	LJT7½M	D	Single Row Angular Contact Ball Bearings
8	10¾	1¾	XLJ8M	B	Single Row Radial Ball Bearings
	13	1¾	LJ8M	B	Single Row Radial Ball Bearings
	13	1¾	LJT8M	D	Single Row Angular Contact Ball Bearings
9	12	1½	XLJ9M	B	Single Row Radial Ball Bearings
	14½	2	LJ9M	B	Single Row Radial Ball Bearings
9½	12¾	1⅞	XLJ9½M	B	Single Row Radial Ball Bearings
10	13¾	1⅞	XLJ10M	B	Single Row Radial Ball Bearings
23,838	62	31,75	BSB093DUHP3	D	Super Precision Bearings
38,1	72	31,75	BSB150DUHP3	D	Super Precision Bearings
44,4754	76,2	31,75	BSB175DUHP3	D	Super Precision Bearings
57,15	90	31,75	BSB225DUHP3	D	Super Precision Bearings

Interchange list

The purpose of the following list is to make it easy for the bearing user to convert to NSK many non-NSK bearings withdrawn from equipment and needing replacing.

The list identifies the bearing series only. The user should then check the relevant table to verify the dimensions and select the precise designation.

Most bearings in use today are manufactured to International Standards and where this is so then NSK offers a direct interchangeable equivalent. In other cases, the NSK product is a functional equivalent in respect of the key features although secondary dimensions may differ. (mainly on mounted units)

There is an enormous range of bearings made by NSK and not listed here. If you cannot find a part number in the list, or if you have any doubt, please contact local NSK office to ensure you get the right equivalent NSK part number.

This list is given in good faith, but no responsibility can be accepted for errors or omissions.

The manufacturers included are:

- › ASAHI
- › FAFNIR
- › FAG
- › HOFFMANN
- › INA
- › NTN
- › POLLARD
- › R&M
- › SKF
- › SNR
- › SEALMASTER

Series Reference	Manufacturer	NSK Bearing Series	Page
100	Hoffmann, Pollard	6200	124
100	FAG	100	*
100ACD	Hoffmann	7200	142
100C	Pollard	6200N	124
100C(W/C)	Pollard	6200NR	124
100CDS	Hoffmann	QJ200	154
100CDSL0C	Hoffmann	QJ200LOC	*
100DR	Hoffmann	4200	140
100GW	Pollard	7200	142
100GWX6	Pollard	7200B	142
100K	Hoffmann	6200N	124
100KR	Hoffmann	6200NR	124
100P	Hoffmann, Pollard	6200Z	124
100PP	Hoffmann, Pollard	6200ZZ	124
100RS	Hoffmann	6200RS	124
100RSS	Hoffmann	6200DDU	124
100Z	Pollard	6200Z	124
100ZZ	Pollard	6200ZZ	124
11200	SKF	11200	*
11200	FAG	11200	*
11300	FAG	11300	*
1200	SKF	1200	160
1200	FAG	1200	160
1200	NTN	1200	160
1200	SNR	1200	160
1200K	NTN	1200K	160
1200K	SNR	1200K	160
1300	SKF	1300	160
1300	FAG	1300	160
1300	NTN	1300	160
1300	SNR	1300	160
1300K	NTN	1300K	160
1300K	SNR	1300K	160
16000	SKF	16000	124
16000	FAG	16000	124
16000	NTN	16000	124
16100	SKF	16100	124
16100	FAG	16100	124
1726200-2RS	SKF	1726200-2RS	*
2-NPPB	INA	1726200-2RS	*
200	SKF	BL200	124
200	SNR	BL200	124
200-ZZ	SKF	BL200ZZ	124
200-ZZNR	SKF	BL200ZZNR	124
200NPPB	Fafnir	1726200-2RS	*
200-Z	SKF	BL200Z	124
200-ZNR	SKF	BL200ZNR	124
21300	SKF	21300	217
21300	FAG	21300	217
21300	SNR	21300	217
2200	SKF	2200	160
2200	FAG	2200	160
2200	NTN	2200	160
2200	SNR	2200	160
2200-2RS.TV	FAG	2200-2RS	160
2200-2RS1	SKF	2200-2RS	160
2200K	NTN	2200K	160
2200K	SNR	2200K	160
22200	SKF	22200	217
22200	FAG	22200	217

Series Reference	Manufacturer	NSK Bearing Series	Page
22200	NTN	22200	217
22200	SNR	22200	217
22300	SKF	22300	217
22300	FAG	22300	217
22300	NTN	22300	217
22300	SNR	22300	217
2300	SKF	2300	160
2300	FAG	2300	160
2300	NTN	2300	160
2300	SNR	2300	160
2300-2RS.TV	FAG	2300-2RS	160
2300-2RS1	SKF	2300-2RS	160
2300K	NTN	2300K	160
2300K	SNR	2300K	160
23000	SKF	23000	217
23000	FAG	23000	217
23000	NTN	23000	217
23000	SNR	23000	217
23100	SKF	23100	217
23100	FAG	23100	217
23100	NTN	23100	217
23100	SNR	23100	217
23200	SKF	23200	217
23200	FAG	23200	217
23200	NTN	23200	217
23200	SNR	23200	217
23300	FAG	23300	217
23900	SKF	23900	217
23900	FAG	23900	217
23900	NTN	23900	217
23900	SNR	23900	217
24000	SKF	24000	217
24000	FAG	24000	217
24000	NTN	24000	217
24000	SNR	24000	217
24100	SKF	24100	217
24100	FAG	24100	217
24100	NTN	24100	217
24100	SNR	24100	217
29200	SKF	29200	231
29200	FAG	29200	231
29200	NTN	29200	231
29300	SKF	29300	231
29300	FAG	29300	231
29300	NTN	29300	231
29300	SNR	29300	231
29400	SKF	29400	231
29400	FAG	29400	231
29400	NTN	29400	231
29400	SNR	29400	231
300	Hoffmann, Pollard	6300	124
300	SKF	BL300	124
300	SNR	BL300	124
300-ZZ	SKF	BL300ZZ	124
300-ZZNR	SKF	BL300ZZNR	124
300ACD	Hoffmann	7300	142
300C	Pollard	6300N	124
300C(W/C)	Pollard	6300NR	124
300CDS	Hoffmann	QJ300	154
300CDSL0C	Hoffmann	QJ300LOC	*

* Consult NSK.

Interchange list

Series Reference	Manufacturer	NSK Bearing Series	Page
300DR	Hoffmann	4300	140
300K	Hoffmann	6300N	124
300KR	Hoffmann	6300NR	124
300NR	SKF	BL300NR	139
300P	Hoffmann	6300Z	124
300P	Pollard	6300DU	124
300PP	Hoffmann	6300ZZ	124
300PP	Pollard	6300DDU	124
300RS	Hoffmann	6300DU	124
300RSS	Hoffmann	6300DDU	124
300Z	Pollard	6300Z	124
300Z	SKF	BL300Z	124
300-ZNR	SKF	BL300ZNR	124
300ZZ	Pollard	6300ZZ	124
30200	SKF	HR30200	185
30200	FAG	HR30200	185
30200	NTN	HR30200	185
30200	SNR	HR30200	185
30300	SKF	HR30300	185
30300	FAG	HR30300	185
30300	NTN	HR30300	185
30300	SNR	HR30300	185
30300D	NTN	HR30300D	185
31300	SKF	HR30300D	185
31300	FAG	HR30300D	185
31300	SNR	HR30300D	185
3200	NTN	3200B	150
3200	SNR	3200B	150
3200A	SKF	3200	150
3200B	FAG	3200B	150
3200B.2RSR	FAG	3200B-2RS	150
3200B.2ZR	FAG	3200B-2Z	150
32000	FAG	HR32000X	185
32000	SNR	HR32000X	185
32000X	SKF	HR32000X	185
32000X	NTN	HR32000X	185
32200	SKF	HR32200	185
32200	FAG	HR32200	185
32200	NTN	HR32200	185
32200	SNR	HR32200	185
32300	SKF	HR32300	185
32300	FAG	HR32300	185
32300	NTN	HR32300	185
32300	SNR	HR32300	185
32900	SKF	HR32900	185
32900	FAG	HR32900	185
32900	NTN	HR32900	185
3300	NTN	3300B	150
3300	SNR	3300B	150
3300A	SKF	3300	150
3300B	FAG	3300B	150
3300B.2RSR	FAG	3300B-2RS	150
3300B.2ZR	FAG	3300B-2Z	150
33000	SKF	HR33000	185
33000	FAG	HR33000	185
33000	NTN	HR33000	185
33000	SNR	HR33000	185
33100	SKF	HR33100	185
33100	FAG	HR33100	185
33100	NTN	HR33100	185

Series Reference	Manufacturer	NSK Bearing Series	Page
33100	SNR	HR33100	185
33200	SKF	HR33200	185
33200	FAG	HR33200	185
33200	NTN	HR33200	185
33200	SNR	HR33200	185
4200	NTN	4200B	140
4200	SNR	4200B	140
4200A	SKF	4200	140
4300	NTN	4300B	140
4300	SNR	4300B	140
4300A	SKF	4300	140
500	Hoffmann, Pollard	6400	124
51100	SKF	51100	231
51100	FAG	51100	231
51100	NTN	51100	231
51100	SNR	51100	231
51200	SKF	51200	231
51200	FAG	51200	231
51200	NTN	51200	231
51200	SNR	51200	231
51300	SKF	51300	231
51300	FAG	51300	231
51300	NTN	51300	231
51300	SNR	51300	231
51400	SKF	51400	231
51400	FAG	51400	231
51400	NTN	51400	231
51400	SNR	51400	231
5200	Sealmaster	1000G	*
5200	NTN	5200	231
5200	SNR	5200	231
52200	SKF	52200	231
52200	FAG	52200	231
52200	NTN	52200	231
52200	SNR	52200	231
52300	SKF	52300	231
52300	FAG	52300	231
52300	NTN	52300	231
52300	SNR	52300	231
52400	SKF	52400	231
52400	NTN	52400	231
52400	SNR	52400	231
5300	Sealmaster	1000G	*
5300	NTN	5300	150
5300	SNR	5300	150
53200	SKF	53200	231
53200	FAG	53200	231
53300	SKF	53300	231
53300	FAG	53300	231
53400	SKF	53400	231
54200	SKF	54200	231
54200	FAG	54200	231
54300	SKF	54300	231
54300	FAG	54300	231
54400	SKF	54400	231
600	SKF	600	124
600	FAG	600	124
600	NTN	600	124
600.2RS	FAG	600DD	124
600.2Z	FAG	600ZZ	124

* Consult NSK.

Series Reference	Manufacturer	NSK Bearing Series	Page
6000	Hoffmann	6000	124
6000	SKF	6000	124
6000	FAG	6000	124
6000	NTN	6000	124
6000.2RSR	FAG	6000DDU	124
6000.2ZR	FAG	6000ZZ	124
6000/HCS	SKF	*	*
6000-2RS1/HCS	SKF	*	*
6000-2RSH/RS1	SKF	6000DDU	124
6000-2RZ	SKF	6000VV	124
6000-2Z	SKF	6000ZZ	124
6000-2Z/VA201	SKF	*	*
6000-2Z/VA208	SKF	*	*
6000-2Z/VA228	SKF	*	*
6000K	Hoffmann	6000N	124
6000KR	Hoffmann	6000NR	124
6000LLB	NTN	6000VV	124
6000LLU	NTN	6000DDU	124
6000N	SKF	6000N	124
6000NR	SKF	6000NR	124
6000NR	NTN	6000NR	124
6000P	Hoffmann	6000Z	124
6000PP	Hoffmann	6000ZZ	124
6000RS	Hoffmann	6000DU	124
6000-RSH/RS1	SKF	6000DU	124
6000RSS	Hoffmann	6000DDU	124
6000Z	SKF	6000Z	124
6000-ZNR	SKF	6000ZNR	124
6000ZZ	NTN	6000ZZ	124
6000ZZNR	NTN	6000ZZNR	124
618/x	SKF	680	124
619/x	SKF	690	124
61800	SKF	6800	124
61900	SKF	6900	124
61800-2RS	SKF	6800DD	124
61800-2RZ	SKF	6800VV	124
61800-2Z	SKF	6800ZZ	124
61900-2RS1	SKF	6900DD	124
61900-2RZ	SKF	6900VV	124
61900-2Z	SKF	6900ZZ	124
620	SKF	620	124
620	FAG	620	124
620	NTN	620	124
620.2RS	FAG	620DD	124
620.2Z	FAG	620ZZ	124
6200	SKF	6200	124
6200	FAG	6200	124
6200	NTN	6200	124
6200.2RSR	FAG	6200DDU	124
6200.2ZR	FAG	6200ZZ	124
6200/HCS	SKF	*	*
6200-2RS1/HCS	SKF	*	*
6200-2RSH/2RS1	SKF	6200DDU	124
6200-2RZ	SKF	6200VV	124
6200-2RZ/HCS	SKF	*	*
6200-2Z	SKF	6200ZZ	124
6200-2Z/VA201	SKF	*	*
6200-2Z/VA208	SKF	*	*
6200-2Z/VA228	SKF	*	*
6200-2ZNR	SKF	6200ZZNR	124

Series Reference	Manufacturer	NSK Bearing Series	Page
6200LLB	NTN	6200VV	124
6200LLU	NTN	6200DDU	124
6200N	SKF	6200N	124
6200NR	SKF	6200NR	124
6200NR	NTN	6200NR	124
6200-RSH/RS1	SKF	6200DU	124
6200VA201	SKF	*	*
6200-Z	SKF	6200Z	124
6200-ZNR	SKF	6200ZNR	124
6200ZZ	NTN	6200ZZ	124
630	SKF	630	124
630	FAG	630	124
630	NTN	630	124
630.2RS	FAG	630DD	124
630.2Z	FAG	630ZZ	124
6300	SKF	6300	124
6300	NTN	6300	124
6300/HCS	SKF	*	*
6300/VA201	SKF	*	*
6300-2RS1/HCS	SKF	*	*
6300-2RSH/RS1	SKF	6300DDU	124
6300-2Z	SKF	6300ZZ	124
6300-2Z/VA201	SKF	*	*
6300-2Z/VA208	SKF	*	*
6300-2ZNR	SKF	6300ZZNR	124
6300LLB	NTN	6300VV	124
6300LLU	NTN	6300DDU	124
6300N	SKF	6300N	124
6300NR	SKF	6300NR	124
6300NR	NTN	6300NR	124
6300-RSH/RS1	SKF	6300DU	124
6300-Z	SKF	6300Z	124
6300-ZNR	SKF	6300ZNR	124
6300ZZ	NTN	6300ZZ	124
6300ZZNR	NTN	6300ZZNR	124
6400	SKF	6400	124
6400	FAG	6400	124
6800	NTN	6800	124
6800LLB	NTN	6800VV	124
6800LLU	NTN	6800DD	124
6800NR	NTN	6800NR	124
6800ZZ	NTN	6800ZZ	124
6800ZZNR	NTN	6800ZZNR	124
6900	NTN	6900	124
6900LLB	NTN	6900VV	124
6900LLU	NTN	6900DD	124
6900NR	NTN	6900NR	124
6900ZZ	NTN	6900ZZ	124
6900ZZNR	NTN	6900ZZNR	124
7200	SNR	7200	142
7200B	SKF	7200B	142
7200B	FAG	7200B	142
7200B	NTN	7200B	142
7300	SNR	7300	142
7300B	SKF	7300B	142
7300B	FAG	7300B	142
7300B	NTN	7300B	142
76200B.2RSR	FAG	1726200-2RS	*
A	Hoffmann	E, EN, L	*
AEL200	NTN	AEL200	*

* Consult NSK.

Interchange list

Series Reference	Manufacturer	NSK Bearing Series	Page
AELFD200	NTN	AELFD200	*
AELPF200	NTN	AELPF200	*
AELPFL200	NTN	AELPFL200	*
AELPP200	NTN	AELPP200	*
AH	SKF	AH	249
AH	FAG	AH	249
AHX	SKF	AHX	249
AHX	FAG	AHX	249
AS200	NTN	AS200	*
ASFD200	NTN	ASFD200	*
ASPF200	NTN	ASPF200	*
ASPFL200	NTN	ASPFL200	*
ASPP200	NTN	ASPP200	*
B200	Asahi	AS200	*
BF200	Asahi	SF-A	*
BFC200	Asahi	FC-A	*
BFL200	Asahi	SFT-A	*
BL200	NTN	BL200	124
BL200ZZ	NTN	BL200ZZ	124
BL300	NTN	BL300	124
BL300ZZ	NTN	BL300ZZ	124
BLCTE200	Asahi	ASFD200	*
BP200	Asahi	NP-A	*
BPF200	Asahi	ASPF200	*
BPFL200	Asahi	ASPFL200	*
BPP200	Asahi	ASPP200	*
BT200	Asahi	ST-A	*
CES200	SNR	1300EC	*
CEX200	SNR	1100DEC	*
CS200LLU	NTN	CS200LLU	*
CS200ZZ	Asahi	CS200LLU	*
CUC200	SNR	1100	*
CUCS200	SNR	1300	*
DLJT	R&M	QJ200LOC o. QJL-LOC	*
DLJT-J	R&M	QJ200 o. QJL	154
DMJT	R&M	QJ300LOC o. QJM-LOC	*
DMJT-J	R&M	QJ300 o. QJM	154
E..KRR	INA	1100DEC	*
ER	Sealmaster	1100CG	*
ES200	SNR	1200ECG	*
ESC200	SNR	SLC-EC	*
ESEHE200	SNR	SCH-EC	*
ESF200	SNR	SF-EC	*
ESFC200	SNR	FC-EC	*
ESFD	SNR	LFTC-EC	*
ESFL200	SNR	SFT-EC	*
ESP200	SNR	NP-EC	*
ESPA200	SNR	SNP-EC	*
ESSP200	SNR	BT-EC	*
EST200	SNR	ST-EC	*
EW	Hoffmann, Pollard	FT	*
EX200	SNR	1000DECG	*
EX200L3	SNR	T1000DECG	*
EXC200	SNR	SLC-DEC	*
EXEHE200	SNR	SCH-DEC	*
EXF200	SNR	SF-DEC	*
EXFC200	SNR	FC-DEC	*
EXP200	SNR	NP-DEC	*

Series Reference	Manufacturer	NSK Bearing Series	Page
EXPA200	SNR	SNP-DEC	*
EXSP200	SNR	BT-DEC	*
EXT200	SNR	ST-DEC	*
FHFC200	Asahi	FC-EC	*
FHLCTE200	Asahi	AELFD200	*
FHPF200	Asahi	AELPF200	*
FHPFL200	Asahi	AELPFL200	*
FHT200	Asahi	ST-EC	*
FLCTE	Fafnir	LFTC-EC	*
FLCTE/GLCTE	INA	LFTC-EC	*
FLCTEY	INA	LFTC-A	*
FRB	SKF	FR	*
FRM	FAG	FR	*
FT	R&M	FT	*
FYC-FM	SKF	FC-EC	*
FYC-RM	SKF	FC-A	*
FYC-TF	SKF	FC	*
FYC-WM	SKF	FC-DEC	*
FY-FM	SKF	SF-EC	*
FYJ-FM	SKF	SF-EC	*
FYJ-RM	SKF	SF-A	*
FYJ-TF	SKF	UCF200	*
FYJ-WF	SKF	UELF200	*
FYK..TH/GFA	SKF	PSF-CR	*
FY-RM	SKF	SF-A	*
FYTB-FM	SKF	SFT-EC	*
FYTBJ-FM	SKF	SFT-EC	*
FYTBJ-RM	SKF	SFT-A	*
FYTBJ-TF	SKF	UCFL200	*
FYTBJ-WF	SKF	UELFL200	*
FYTBK..TH/GFA	SKF	PSFT-CR	*
FYTB-RM	SKF	SFT-A	*
FYTB-TF	SKF	SFT	*
FYTB-WF	SKF	SFT-DEC	*
FY-TF	SKF	SF	*
FY-WF	SKF	SF-DEC	*
G..KRRBW	INA	1000DECG	*
GAY-NPPB	INA	1200G	*
GE..KRRB FA101T	INA	1000DECGHLT	*
GE..KRRB-CC	INA	1000DECGFS	*
GE-KPPB	Fafnir	T1000DECG	*
GE-KPPB3	INA	T1000DECG	*
GE-KRRB	INA	1000DECG	*
GE-KRRB	Fafnir	1000DECG	*
GLCTE	Fafnir	LFTC-EC	*
GNP	SNR	PNP-CR	*
GRA..NPPBW	INA	1200ECG	*
GRAE-NPPB	INA	1200ECG	*
GRAE-NPPB	Fafnir	1200ECG	*
GSF	SNR	PSF-CR	*
GSFT	SNR	PSFT-CR	*
GSH-RRB	INA	1000KG	*
GW208PPB5	Fafnir	1/PDNF240/9G	*
GW208PPB6	Fafnir	1/PDNF240/8G	*
GW208PPB8	Fafnir	PDNF240/9G	*
GW209PPB11	Fafnir	28/DNF245-45G	*
GW209PPB2	Fafnir	PDNF145-45G	*
GW209PPB5	Fafnir	PDNF245/10G	*
GW209PPB8	Fafnir	DNF245/10G	*
GW210PP4	Fafnir	PDF150/9G	*

* Consult NSK.

Series Reference	Manufacturer	NSK Bearing Series	Page
GW210PPB2	Fafnir	PDNF150-1.15/16G	*
GW210PPB4	Fafnir	PDNF150/9G	*
GW211PP2	Fafnir	PDF155-2.3/16G	*
GW211PP3	Fafnir	PDF155/12G	*
GY..KRRBW	INA	1000G	*
GYE..KRRB VA	INA	J1000GCR	*
GYE-KRRB	INA	1000G	*
H	SKF	H	249
H	FAG	H	249
HA	SKF	HA	249
HE	SKF	HE	249
HJ	SKF	HJ	*
HJ	FAG	HJ	*
KH200+ER	Asahi	AEL200	*
KLNJ	R&M	KLNJ	124
KLNJ-D	R&M	KLNJ-Z	124
KLNJ-DD	R&M	KLNJ-ZZ	124
KLNJ-WSR	R&M	KLNJ-2RS	124
KM	SKF	AN/KM	249
KM	FAG	AN/KM	249
L200	Fafnir	1200	160
L300	Fafnir	1300	160
L6200	Fafnir	2200	160
L6300	Fafnir	2300	160
L-CDS	Hoffmann	QJL	154
L-CDSLOC	Hoffmann	QJL-LOC	*
LDJ	R&M	4200	140
LDJ-K	R&M	LDJK	*
LJ	R&M	6200	124
LJBL	R&M	BL200	124
LJBL-D	R&M	BL200Z	124
LJBL-DD	R&M	BL200ZZ	124
LJ-D	R&M	6200Z o. LJ-Z	124
LJ-DD	R&M	6200ZZ o. LJ-ZZ	124
LJ-G	R&M	6200N o. LJ-N	124
LJ-GWC	R&M	6200NR o. LJ-NR	124
LJT	R&M	7200 o. LJ-T	142
LJT-X6	R&M	7200B	142
LJ-WSR	R&M	6200DU o. LJ-RS	124
LJ-WSRR	R&M	6200DDU o. LJ-2RS	124
LLRJ	R&M	NU200 o. LLRJ	168
LLRJA	R&M	NJ200 o. LLRJ A	168
LLRJB	R&M	NUP200 o. LLRJB	168
LRJ	R&M	N200 o. LRJ	168
LRJA	R&M	NF200 o. LRJA	168
LS	Hoffmann, Pollard	LJ	124
LS-ACD	Hoffmann	LJT	142
LS-C	Pollard	LJ-N	124
LS-C(W/C)	Pollard	LJ-NR	124
LS-GW	Pollard	LJT	142
LS-K	Hoffmann	LJ-N	124
LS-KR	Hoffmann	LJ-NR	124
LS-P	Hoffmann	LJ-Z	124
LS-P	Pollard	LJ-RS	124
LS-PP	Hoffmann	LJ-ZZ	124
LS-PP	Pollard	LJ-2RS	124
LS-RS	Hoffmann	LJ-RS	124
LS-RSS	Hoffmann	LJ-2RS	124
LS-Z	Pollard	LJ-Z	124
LS-ZZ	Pollard	LJ-ZZ	124

Series Reference	Manufacturer	NSK Bearing Series	Page
LT-(B)	R&M	LT-(B)	*
M	R&M	E, EN, L	*
MB	SKF	AW	249
M-CDS	Hoffmann	QJM	154
M-CDSLOC	Hoffmann	QJM-LOC	*
MDJ	R&M	4300	140
MDJ-K	R&M	MDJK	*
MFC	Sealmaster	MFC	*
MJ	R&M	6300	124
MJBL	R&M	BL300	124
MJBL-D	R&M	BL300Z	124
MJBL-DD	R&M	BL300ZZ	124
MJ-D	R&M	6300Z o. MJ-Z	124
MJ-DD	R&M	6300ZZ o. MJ-ZZ	124
MJ-G	R&M	6300N o. MJ-N	124
MJ-GWC	R&M	6300NR o. MJ-NR	124
MJT	R&M	7300 o. MJ-T	142
MJT-X6	R&M	7300B	142
MJ-WSR	R&M	6300DU o. MJ-RS	124
MJ-WSRR	R&M	6300DDU o. MJ-2RS	124
MMRJ	R&M	NU300 o. MMRJ	168
MMRJA	R&M	NJ300 o. MMRJA	168
MMRJB	R&M	NUP300 o. MMRJB	168
MP	Sealmaster	MP	*
MRJ	R&M	N300 o. MRJ	168
MRJA	R&M	NF300 o. MRJA	168
MS	Hoffmann, Pollard	MJ	124
MS-ACD	Hoffmann	MJT	142
MSC	Sealmaster	MSC	*
MS-C	Pollard	MJ-N	124
MS-C(W/C)	Pollard	MJ-NR	124
MSF	Sealmaster	MSF	*
MSFT	Sealmaster	MSFT	*
MS-GW	Pollard	MJT	142
MS-K	Hoffmann	MJ-N	124
MS-KR	Hoffmann	MJ-NR	124
MS-P	Hoffmann	MJ-Z	124
MS-P	Pollard	MJ-RS	124
MS-PP	Hoffmann	MJ-ZZ	124
MS-PP	Pollard	MJ-2RS	124
MS-RS	Hoffmann	MJ-RS	124
MS-RSS	Hoffmann	MJ-2RS	124
MST	Sealmaster	MST	*
MS-Z	Pollard	MJ-Z	124
MS-ZZ	Pollard	MJ-ZZ	124
MT	R&M	MT	231
MUC..FD	SNR	J1000GCR	*
MW	Hoffmann, Pollard	MT	231
N1000	NTN	N1000	168
N1000	SNR	N1000	168
N1800	Fafnir	51200	231
N200	SKF	N200	168
N200	FAG	N200	168
N200	NTN	N200	168
N200	SNR	N200	168
N2200	NTN	N2200	168
N2200	SNR	N2200	168
N2300	NTN	N2300	168
N2300	SNR	N2300	168
N300	SKF	N300	168

* Consult NSK.

Interchange list

Series Reference	Manufacturer	NSK Bearing Series	Page
N300	FAG	N300	168
N300	NTN	N300	168
N300	SNR	N300	168
N400	NTN	N400	168
N400	SNR	N400	168
NCF1800V	SKF	NCF1800	*
NCF2200V	SKF	NCF2200	*
NCF2900	FAG	NCF2900	*
NCF2900V	SKF	NCF2900	*
NCF3000	FAG	NCF3000	*
NCF3000V	SKF	NCF3000	*
NF200	NTN	NF200	168
NF300	NTN	NF300	168
NJ1000	NTN	NJ1000	168
NJ1000	SNR	NJ1000	168
NJ200	SKF	NJ200	168
NJ200	FAG	NJ200	168
NJ200	NTN	NJ200	168
NJ200	SNR	NJ200	168
NJ2200	SKF	NJ2200	168
NJ2200	FAG	NJ2200	168
NJ2200	NTN	NJ2200	168
NJ2200	SNR	NJ2200	168
NJ2300	SKF	NJ2300	168
NJ2300	FAG	NJ2300	168
NJ2300	NTN	NJ2300	168
NJ2300	SNR	NJ2300	168
NJ300	SKF	NJ300	168
NJ300	FAG	NJ300	168
NJ300	NTN	NJ300	168
NJ300	SNR	NJ300	168
NJ400	SKF	NJ400	168
NJ400	NTN	NJ400	168
NJ400	SNR	NJ400	168
NLDJ	R&M	2200	160
NLJ	R&M	1200 o. NLJ	160
NMDJ	R&M	2300	160
NMJ	R&M	1300 o. NMJ	160
NN3000	FAG	NN3000	259
NN3000	NTN	NN3000	259
NNCF4800	SKF	NNCF4800	*
NNCF4900	SKF	NNCF4900	*
NNCF5000	SKF	NNCF5000	*
NNU4900	NTN	NNU4900	*
NP	Sealmaster	NP	*
NU1000	SKF	NU1000	168
NU1000	FAG	NU1000	168
NU1000	NTN	NU1000	168
NU1000	SNR	NU1000	168
NU200	SKF	NU200	168
NU200	FAG	NU200	168
NU200	NTN	NU200	168
NU200	SNR	NU200	168
NU2200	SKF	NU2200	168
NU2200	FAG	NU2200	168
NU2200	NTN	NU2200	168
NU2200	SNR	NU2200	168
NU2300	SKF	NU2300	168
NU2300	FAG	NU2300	168
NU2300	NTN	NU2300	168

Series Reference	Manufacturer	NSK Bearing Series	Page
NU2300	SNR	NU2300	168
NU300	SKF	NU300	168
NU300	FAG	NU300	168
NU300	NTN	NU300	168
NU300	SNR	NU300	168
NU400	SKF	NU400	168
NU400	NTN	NU400	168
NUP1000	NTN	NUP1000	168
NUP1000	SNR	NUP1000	168
NUP200	SKF	NUP200	168
NUP200	FAG	NUP200	168
NUP200	NTN	NUP200	168
NUP200	SNR	NUP200	168
NUP2200	SKF	NUP2200	168
NUP2200	FAG	NUP2200	168
NUP2200	NTN	NUP2200	168
NUP2200	SNR	NUP2200	168
NUP2300	SKF	NUP2300	168
NUP2300	FAG	NUP2300	168
NUP2300	NTN	NUP2300	168
NUP2300	SNR	NUP2300	168
NUP300	SKF	NUP300	168
NUP300	FAG	NUP300	168
NUP300	NTN	NUP300	168
NUP300	SNR	NUP300	168
NUP400	NTN	NUP400	168
P200	Pollard	1200	160
P300	Pollard	1300	160
P3200	Pollard	2200	160
P3300	Pollard	2300	160
PASE	INA	NP-EC	*
PASE	Fafnir	NP-EC	*
PASEY	INA	NP-A	*
PB	INA	LPB-EC	*
PB	Fafnir	LPB-EC	*
PBY	INA	LPB-A	*
PCF	Fafnir	SF-EC	*
PCFT	Fafnir	SFT-EC	*
PCJ	INA	SF-EC	*
PCJT	INA	SFT-EC	*
PCJTY	INA	SFT-A	*
PCJY	INA	SF-A	*
PFD-FM	SKF	SLFT-EC	*
PFD-RM	SKF	SLFT-A	*
PFD-TF	SKF	SLFT	*
PFD-WF	SKF	SLFT-DEC	*
PF-FM	SKF	SLFE-EC	*
P-FM	SKF	LPB-EC	*
PF-RM	SKF	SLFE-A	*
PF-TF	SKF	SLFE	*
PFT-FM	SKF	SLFL-EC	*
PFT-RM	SKF	SLFL-A	*
PFT-TF	SKF	SLFL	*
PFT-WF	SKF	SLFL-DEC	*
PF-WF	SKF	SLFE-DEC	*
PHE	INA	SCH-EC/SCHB-	*
PHE	Fafnir	SCH-EC	*
PHEY	INA	SCH-A/SCHB-A	*
PHUSE	INA	BT-EC u. BTHF	*
PME	INA	FC-EC	*

* Consult NSK.

Series Reference	Manufacturer	NSK Bearing Series	Page
PMEY	INA	FC-A	*
PMNE	Fafnir	FC-EC	*
P-RM	SKF	LPB-A o. ASPP200	*
PSHE	INA	SNP-EC	*
PSHE	Fafnir	SNP-EC	*
PSHEY	INA	SNP-A	*
P-TF	SKF	LPB	*
PTUE	INA	ST-EC	*
PTUE	Fafnir	ST-EC	*
PTUEY	INA	ST-A	*
P-WF	SKF	LPB-DEC	*
QJ200	SKF	QJ200	154
QJ200	FAG	QJ200	154
QJ200	NTN	QJ200	154
QJ200	SNR	QJ200	154
QJ300	SKF	QJ300	154
QJ300	FAG	QJ300	154
QJ300	NTN	QJ300	154
QJ300	SNR	QJ300	154
R	NTN	R	*
R100	Hoffmann, Pollard	N200	168
R100E	Hoffmann, Pollard	NU200	168
R100F	Hoffmann, Pollard	NUP200	168
R100L	Hoffmann, Pollard	NF200	168
R100P	Hoffmann, Pollard	NJ200	168
R300	Hoffmann, Pollard	N300	168
R300E	Hoffmann, Pollard	NU300	168
R300F	Hoffmann, Pollard	NUP300	168
R300L	Hoffmann, Pollard	NJ300	168
R300P	Hoffmann, Pollard	NJ300	168
RA	INA	SLFE-EC	*
RA	Fafnir	SLFE-EC	*
RA..NPPW	INA	1300EC	*
RAE..NPP	INA	1300EC	*
RAE..NPP	Fafnir	1300EC	*
RAK	Fafnir	SL-DEC	*
RAKC	Fafnir	SL	*
RAKHP	Fafnir	MP	*
RASE	Fafnir	NP-DEC	*
RASE	INA	NP-DEC	*
RASE..FA101T	INA	NP-HLT	*
RASEA	INA	NP1000KG	*
RASEY	INA	NP	*
RASEY..TN VA	INA	PNP-CR	*
RAT	INA	SLFL-EC	*
RAT	Fafnir	SLFL-EC	*
RATR	INA	SLFT-EC	*
RATR	Fafnir	SLFT-EC	*
RATRY	INA	SLFT-A	*
RATY	INA	SLFL-A	*
RAY	INA	SLFE-A	*
RC	Fafnir	SLC-DEC	*
RCC	Fafnir	SLC	*
RCE	Fafnir	SLC-DEC	*
RCHP	Fafnir	MSC	*
RCJ	Fafnir	SF-DEC	*
RCJ	INA	SF-DEC	*
RCJ..FA101T	INA	SF-HLT	*
RCJHP	Fafnir	MSF	*
RCJT	Fafnir	SFT-DEC	*

Series Reference	Manufacturer	NSK Bearing Series	Page
RCJT	INA	SFT-DEC	*
RCJT..FA101T	INA	SFT-HLT	*
RCJTA	INA	SFT1000KG	*
RCJTHP	Fafnir	MSFT	*
RCJTY	INA	SFT	*
RCJY	INA	SF	*
RCJY..TN VA	INA	PSF-CR	*
RFC	Fafnir	MFC	*
RFHP	Fafnir	MFC	*
RHCM	Fafnir	SCHB	*
RHE	Fafnir	SCH-DEC	*
RHE	INA	SCH-DEC/ SCHB-DEC	*
RHEY	INA	SCH/SCHB	*
RL	Hoffmann, Pollard	NLJ	160
RL-E	Hoffmann	LLRJ	168
RLS	Hoffmann, Pollard	LRJ	168
RLS-E	Pollard	LLRJ	168
RM	Pollard	NMJ	160
RM-E	Hoffmann	MMRJ	*
RME	INA	FC-DEC	*
RMEY	INA	FC	*
RMNE	Fafnir	FC-DEC	*
RMS	Hoffmann, Pollard	MRJ	168
RMS-E	Pollard	MMRJ	*
RPB	Fafnir	LPBR-EC	*
RR	Fafnir	SLFE-DEC	*
RR	INA	SLFE-DEC	*
RRT	Fafnir	SLFL-DEC	*
RRT	INA	SLFL-DEC	*
RRTR	INA	SLFT-DEC	*
RRTR	Fafnir	SLFT-DEC	*
RRTY	INA	SLFL	*
RRY	INA	SLFE	*
RSHE	Fafnir	SNP-DEC	*
RSHE	INA	SNP-DEC	*
RSHEY	INA	SNP	*
RTT	INA	TSLFL-DEC	*
RTTR	INA	TSLFT-DEC	*
RTUE	Fafnir	ST-DEC	*
RTUE	INA	ST-DEC	*
RTUEY	INA	ST	*
RTUHP	Fafnir	MST	*
RXLS	Hoffmann	XLRJ	168
S	Hoffmann	KLNJ	124
SC	Pollard	KLNJ	124
SC	Sealmaster	SLC	*
SCHB	Sealmaster	SCHB	*
SF	Sealmaster	SF	*
SFT	Sealmaster	SFT	*
SI100	Pollard	QJ200	154
SI100LOC	Pollard	QJ200LOC	*
SI300	Pollard	QJ300	154
SI300LOC	Pollard	QJ300LOC	*
SILS	Pollard	QJL	154
SILS-LOC	Pollard	QJL-LOC	*
SIMS	Pollard	QJM	154
SIMS-LOC	Pollard	QJM-LOC	*
SLG	Sealmaster	SL	*
SPR	SNR	BTHF	*

* Consult NSK.

Interchange list

Series Reference	Manufacturer	NSK Bearing Series	Page
SRP	Sealmaster	LPBR	*
SSF	Sealmaster	SLFE	*
SSP	Sealmaster	LPB	*
ST	Sealmaster	ST	*
SYF-FM	SKF	SNP-EC	*
SYFJ-FM	SKF	SNP-EC	*
SYFJ-RM	SKF	SNP-A	*
SYFJ-TF	SKF	UCUP200	*
SYFJ-WF	SKF	SNP-DEC	*
SY-FM	SKF	NP-EC	*
SYF-RM	SKF	SNP-A	*
SYF-TF	SKF	SNP	*
SYF-WF	SKF	SNP-DEC	*
SYJ-FM	SKF	NP-EC	*
SYJ-RM	SKF	NP-A	*
SYJ-TF	SKF	UCP200	*
SYJ-WF	SKF	UEL200	*
SYK...TH/GFA	SKF	PNP-CR	*
SY-RM	SKF	NP-A	*
SY-TF	SKF	NP	*
SY-WF	SKF	NP-DEC	*
TASE	INA	TNP-DEC	*
TASE	Fafnir	TNP-DEC	*
TB	INA	TLPB-DEC	*
TB	Sealmaster	CNP	*
TJ	Fafnir	TSF-DEC	*
TJ	INA	TSF-DEC	*
TJ	INA	TSFT-DEC	*
TJ	Fafnir	TSFT-DEC	*
TJTY...TN VA	INA	PSFT-CR	*
THE	INA	TSCH-DEC/ TSCHB-DEC	*
THE	Fafnir	TSCH-DEC	*
TME	INA	TFC-DEC	*
TMNE	Fafnir	TFC-DEC	*
TR	INA	TSLFE-DEC	*
TSHE	INA	TSNP-DEC	*
TSHE	Fafnir	TSNP-DEC	*
TTUE	INA	TST-DEC	*
TTUE	Fafnir	TST-DEC	*
TU-FM	SKF	ST-EC	*
TUJ-FM	SKF	ST-EC	*
TUJ-RM	SKF	ST-A	*
TUJ-TF	SKF	UCT200	*
TUJ-WF	SKF	UEL200	*
TU-RM	SKF	ST-A	*
TU-TF	SKF	ST	*
TU-WF	SKF	ST-DEC	*
U100	Hoffmann	1200	160
U100W	Hoffmann	2200	160
U200	FAG	U200	*
U300	Hoffmann	1300	160
U300	FAG	U300	*
U300W	Hoffmann	2300	160
UC200	Asahi	UC200	*
UC200	NTN	UC200	*
UC200	SNR	1000G	*
UC200L3	SNR	T1000G	*
UC300	Asahi	UC300	*
UC300	NTN	UC300	*

Series Reference	Manufacturer	NSK Bearing Series	Page
UCC200	SNR	SLC	*
UCEH200	Asahi	UCHB200	*
UCEHE200	SNR	SCH	*
UCF200	Asahi	UCF200	*
UCF200	NTN	UCF200	*
UCF200	SNR	SF	*
UCF300	NTN	UCF300	*
UCFC200	Asahi	UCFC200	*
UCFC200	NTN	UCFC200	*
UCFC200	SNR	FC	*
UCFC300	NTN	UCFC300	*
UCFCX00	Asahi	UCFCX00	*
UCFCX00	NTN	UCFCX00	*
UCFH200	NTN	UCFH200	*
UCFK200	Asahi	UCFH200	*
UCFL200	Asahi	UCFL200	*
UCFL200	NTN	UCFL200	*
UCFL200	SNR	SFT	*
UCFL300	NTN	UCFL300	*
UCFLX00	Asahi	UCFLX00	*
UCFLX00	NTN	UCFLX00	*
UCFX00	Asahi	UCFX00	*
UCFX00	NTN	UCFX00	*
UCHB200	NTN	UCHB200	*
UCP200	Asahi	UCP200	*
UCP200	NTN	UCP200	*
UCP200	SNR	NP	*
UCP300	NTN	UCP300	*
UCPA200	Asahi	UCUP200	*
UCPA200	SNR	SNP	*
UCPX00	Asahi	UCPX00	*
UCPX00	NTN	UCPX00	*
UCSP200	SNR	BT	*
UCT200	Asahi	UCT200	*
UCT200	NTN	UCT200	*
UCT200	SNR	ST	*
UCT300	NTN	UCT300	*
UCTX00	NTN	UCTX00	*
UCUP200	NTN	UCUP200	*
UCX00	NTN	UCX00	*
UEL200	NTN	UEL200	*
UELF200	NTN	UELF200	*
UELFC200	NTN	UELFC200	*
UELFL200	NTN	UELFL200	*
UELP200	NTN	UELP200	*
UELT200	NTN	UELT200	*
UG200+ER	Asahi	UEL200	*
UGF200	Asahi	UELF200	*
UGFC200	Asahi	UELFC200	*
UGFL200	Asahi	UELFL200	*
UGP200	Asahi	UELP200	*
UGT200	Asahi	UELT200	*
UHF200	Asahi	SF-EC	*
UHFL200	Asahi	SFT-EC	*
UHP200	Asahi	NP-EC	*
UHPP200	Asahi	AELPP200	*
UK200	Asahi	UK200	*
UK200	NTN	UK200	*
UK200	SNR	1000KG	*
UK200	SNR	SLC1000K	*

* Consult NSK.

Series Reference	Manufacturer	NSK Bearing Series	Page
UKEHE200	SNR	SCH1000K	*
UKF200	SNR	SF1000K	*
UKFL200	SNR	SFT1000K	*
UKP200	SNR	NP1000K	*
UKPA200	SNR	SNP1000K	*
UKT200	SNR	ST1000K	*
ULS	Hoffmann	NLJ	160
UMS	Hoffmann	NMJ	160
US200	SNR	1200G	*
USC200	SNR	SLC-A	*
USEHE200	SNR	SCH-A	*
USF200	SNR	SF-A	*
USFC200	SNR	FC-A	*
USFD	SNR	LFTC-A	*
USFL200	SNR	SFT-A	*
USP200	SNR	NP-A	*
USPA200	SNR	SNP-A	*
USSP200	SNR	BT-A	*
UST200	SNR	ST-A	*
VAK	Fafnir	SL-EC	*
VAS	Fafnir	NP-EC	*
VCJ	Fafnir	SF-EC	*
VCJT	Fafnir	SFT-EC	*
VMNE	Fafnir	FC-EC	*
VSHE	Fafnir	SNP-EC	*
W	Hoffmann, Pollard	LT-(B)	*
W208PP10	Fafnir	36/DF140-1.1/2	*
W208PP5	Fafnir	2/DF240/9	*
W208PP6	Fafnir	2/DF240/8	*
W208PP8	Fafnir	PDF240/9	*
W208PP9	Fafnir	PDNF240/8	*
W208PPB13	Fafnir	2/DNF240/7	*
W208PPB2	Fafnir	36/PDNF140-1.1/2	*
W208PPB4	Fafnir	PDNF140-1.3/16	*
W208PPB5	Fafnir	2/DNF240/9	*
W208PPB6	Fafnir	2/DNF240/8	*
W208PPB7	Fafnir	2/DNF140-1.3/16	*
W208PPB8	Fafnir	PDNF240/9	*
W208PPB9	Fafnir	PDNF240/8	*
W209PPB2	Fafnir	PDNF145-45	*
W209PPB4	Fafnir	28/PDNF145-1.1/2	*
W209PPB5	Fafnir	PDNF245/10	*
W209PPB8	Fafnir	DNF245/10	*
W210PP2	Fafnir	PDF150-1.15/16	*
W210PP4	Fafnir	PDF150/9	*
W210PPB2	Fafnir	PDNF150-1.15/16	*
W210PPB4	Fafnir	PDNF150/9	*
W210PPB5	Fafnir	5/PDNF150-1.3/4	*
W210PPB6	Fafnir	PDNF250/9	*
W211PP2	Fafnir	PDF155-2.3/16	*
W211PP3	Fafnir	PDF155/12	*
W211PPB2	Fafnir	PDNF155-2.3/16	*
W211PPB3	Fafnir	PDNF155/12	*
W6000	SKF	6000-H-20	*
W6000-2RS1	SKF	6000-H-20DDU	*
W6000-2Z	SKF	6000-H-20ZZ	*
W61800	SKF	6800-H-20	*
W61800-2Z	SKF	6800-H-20ZZ	*
W61900	SKF	6900-H-20	*
W61900-2RS	SKF	6900-H-20DD	*

Series Reference	Manufacturer	NSK Bearing Series	Page
W61900-2Z	SKF	6900-H-20ZZ	*
W6200	SKF	6200-H-20	*
W6200-2RS	SKF	6200-H-20DD	*
W6200-2Z	SKF	6200-H-20ZZ	*
XLJ	R&M	XLJ	124
XLRJ	R&M	XLRJ	168
XLS	Hoffmann, Pollard	XLJ	124
XLT	R&M	XLT	231
XW	Hoffmann	XLT	231
XX100	Pollard	6000	124
XX100C	Pollard	6000N	124
XX100C(W/C)	Pollard	6000NR	124
XX100P	Pollard	6000DU	124
XX100PP	Pollard	6000DDU	124
XX100Z	Pollard	6000Z	124
XX100ZZ	Pollard	6000ZZ	124
XXLJ	R&M	6000	124
XXLJ-D	R&M	6000Z	124
XXLJ-DD	R&M	6000ZZ	124
XXLJ-G	R&M	6000N	124
XXLJ-GWC	R&M	6000NR	124
XXLJT	R&M	7000	142
XXLJ-WSR	R&M	6000DU	124
XXLJ-WSRR	R&M	6000DDU	124
XXLRJ	R&M	N1000	168
YAR2...2RF/HVGFA	SKF	J1000GCR	*
YAR-2-2RF	SKF	1000GFS	*
YAR-2F	SKF	1000G	*
YAT200	SKF	1200G	*
YEL200-2F	SKF	1000DECG	*
YET200	SKF	1200ECG	*
YSA200-2FK	SKF	1000KG	*

* Consult NSK.

Bearing Tables



Table of Contents

Single Row Deep Groove Ball Bearings	122
Extra Small Ball Bearings	138
Maximum Type Ball Bearings	139
Double Row Deep Groove Ball Bearings	140
Single Row Angular Contact Ball Bearings	144
Double Row Angular Contact Ball Bearings	152
Duplex Ball Bearings	156
Self Aligning Ball Bearings	162
Single Row Cylindrical Roller Bearings	170
Single Row Tapered Roller Bearings	186
Spherical Roller Bearings	218
Thrust Bearings	228
Accessories	244
Super Precision Bearings	253
Other Product Ranges	261

Single Row Deep Groove Ball Bearings



Basic Type & Series

- 600: Metric, extra small
- 16000: Metric, thin section
- 6000: Metric, extra light
- 6200: Metric, light
- 6300: Metric, medium
- 6800: Metric, extra thin section
- 6900: Metric, very thin section
- BL 200: Metric, maximum capacity, light
- BL 300: Metric, maximum capacity, medium
- KLNJ: Inch, small
- XLJ: Inch, extra light
- IJ: Inch, light
- MJ: Inch, medium

Features

- V: Single non-contact seal
- VV: Double non-contact seal
- Z: Single shield
- ZZ: Double shield
- DU: Single contact seal
- DDU: Double contact seal
- NR: Snap ring and groove
- M: Brass cage
- Blank: Steel cage

Noise Level

- E: Electric Motor Grade

62

05

ZZ

C3

E

Bore Diameter

(04 and up: multiply last two numbers by 5 to get bore in mm)

- 00: 10 mm 03: 17 mm 12: 60 mm
- 01: 12 mm 04: 20 mm 20: 100 mm
- 02: 15 mm 05: 25 mm

Inch: directly indicated

Internal Clearance

- C2: Tight
- Blank: Normal
- C3: Loose
- C4: Extra Loose

Design, types and features

Single Row Deep Groove Ball Bearings are classified into the types shown below:

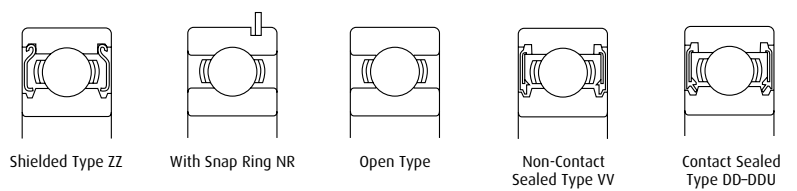

Applications

- › Transmissions › Electric Motors & Generators › Electrical Appliances › Pumps & Compressors › Blowers & Fans
- › Speed Changers › Gear Boxes & Drives › Woodworking Machinery › Lawn & Garden Equipment › Turbines
- › Farm Machinery › Construction Machinery › Oil Field Machinery › Elevators › Conveying Equipment › Hoists & Cranes
- › Power Hand Tools › Industrial Valves › Rolling Mill Machinery › Textile Machinery › Paper Machinery › Printing Machinery
- › Food Products Machinery › Packaging Machinery › Medical & Dental Equipment (Extra Small) › Robotics Equipment (Thin)
- › Industrial Clutches › Slip Joints › Skate Boards (608ZZ) › Inline Skates (608ZZ)

Single Row Deep Groove Ball Bearings

Radial Internal Clearances

Nominal Bore Diameter d (mm)		Clearance									
		C2		CN		C3		C4		C5	
over	include	min.	max.	min.	max.	min.	max.	min.	max.	min.	max.
10 only		0	7	2	13	8	23	14	29	20	37
10	18	0	9	3	18	11	25	18	33	25	45
18	24	0	10	5	20	13	28	20	36	28	48
24	30	1	11	5	20	13	28	23	41	30	53
30	40	1	11	6	20	15	33	28	46	40	64
40	50	1	11	6	23	18	36	30	51	45	73
50	65	1	15	8	28	23	43	38	61	55	90
65	80	1	15	10	30	25	51	46	71	65	105
80	100	1	18	12	36	30	58	53	84	75	120
100	120	2	20	15	41	36	66	61	97	90	140
120	140	2	23	18	48	41	81	71	114	105	160
140	160	2	23	18	53	46	91	81	130	120	180
160	180	2	25	20	61	53	102	91	147	135	200
180	200	2	30	25	71	63	117	107	163	150	230
200	225	2	35	25	85	75	140	125	195	175	265
225	250	2	40	30	95	85	160	145	225	205	300
250	280	2	45	35	105	90	170	155	245	225	340
280	315	2	55	40	115	100	190	175	270	245	370
315	355	3	60	45	125	110	210	195	300	275	410
355	400	3	70	55	145	130	240	225	340	315	460

To obtain the measured values, use the clearance correction for radial clearance increase caused by the measuring load in the table below.

For the C2 clearance class, the smaller value should be used for bearings with minimum clearance and the larger value for bearings near the maximum clearance range. Units: μm

Nominal Bore Diameter d (mm)		Measuring load		Clearance Correction Value				
over	incl.	(N)	{kgf}	C2	CN	C3	C4	C5
10 (incl.)	18	24,5	{2,5}	3-4	4	4	4	4
18	50	49	{5}	4-5	5	6	6	6
50	280	147	{15}	6-8	8	9	9	9

For values over 280mm please contact NSK. Units: μm



Radial Internal Clearances in Extra Small and Miniature Ball Bearings

Clearance Symbol	MC1		MC2		MC3		MC4		MC5		MC6	
	min.	max.	min.	max.	min.	max.	min.	max.	min.	max.	min.	max.
Clearance	0	5	3	8	5	10	8	13	13	20	20	28
Clearance Symbol	MC1		MC2		MC3		MC4		MC5		MC6	
Clearance Correction Value	1		1		1		1		2		2	

The standard clearance is MC3. To obtain the measured value, add correction amount in the table. The measuring loads are as follows: For miniature ball bearings $\sim 2.5N$ {0.25 kgf}; For extra small ball bearings $\sim 4.4N$ {0.45 kgf}. *For their classification, refer to Table 1 on Page B 31 in Cat: RB/A/... . Units: μm

Interchange

	Description	NSK	SKF	FAG	NTN	SNR
Part Number	See Interchange list					
Suffixes	1 seal (contact)	DU	RS1/RSH	RSR	LU	E
	2 seals (contact)	DDU	2RS1/2RSH	2RSR	LLU	EE
	2 seals (non contact)	VV	2RZ	2RSD	LLB	
	1 shield	Z	Z	ZR	Z	Z
	2 shields	ZZ	ZZ	ZZR	ZZ	ZZ
	Snap ring	NR	NR	NR	NR	NR
	Steel cage	Blank	Blank	Blank	Blank	Blank
	Brass cage	M	M	M	M	M
	Tight clearance	C2	C2	C2	C2	J20
	Normal clearance	Blank	Blank	Blank	Blank	Blank
	Loose clearance	C3	C3	C3	C3	J30
	Extra loose clearance	C4	C4	C4	C4	J40

Single Row Deep Groove Ball Bearings

Bore Diameter 10 – 22 mm

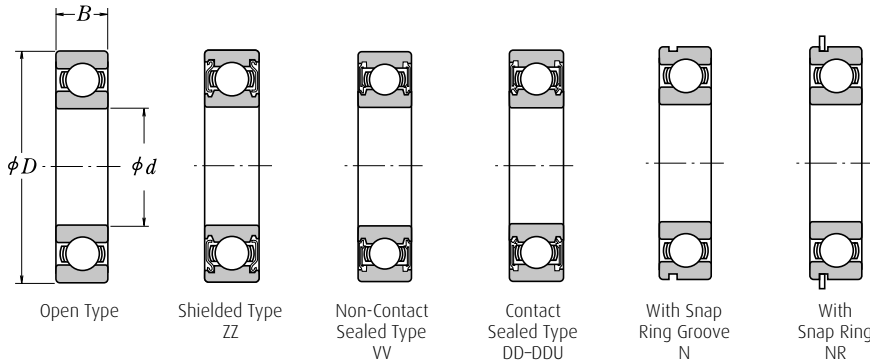

Boundary Dimensions (mm)			Basic Load Ratings (N)		Limiting Speeds (min ⁻¹)			Bearing Numbers					Mass (kg)	
d	D	B	C _r	C _{0r}	Grease		Oil	Open	Shielded	Sealed	With Snap Ring Groove	With Snap Ring	approx	
					Open Z ZZ V VV	DU DDU	Open Z							
10	19	5	1 720	840	34 000	24 000	40 000	6800	ZZ	VV	DD	-	-	0,005
	22	6	2 700	1 270	32 000	22 000	38 000	6900	ZZ	VV	DD	N	N	0,009
	26	8	4 550	1 970	30 000	22 000	36 000	6000	ZZ	VV	DDU	N	N	0,018
	28	8	4 800	2 030	28 000	18 000	34 000	16100	ZZR	VV	2RSR	-	-	0,020
	30	9	5 100	2 390	24 000	18 000	30 000	6200	ZZ	VV	DDU	N	NR	0,032
	35	11	8 100	3 450	22 000	17 000	26 000	6300	ZZ	VV	DDU	N	NR	0,052
12	21	5	1 920	1 040	32 000	20 000	38 000	6801	ZZ	VV	DD	-	-	0,006
	24	6	2 890	1 460	30 000	20 000	36 000	6901	ZZ	VV	DD	N	NR	0,010
	28	7	5 100	2 370	28 000	-	32 000	16001	-	-	-	-	-	0,019
	28	8	5 100	2 370	28 000	18 000	32 000	6001	ZZ	VV	DDU	N	N	0,022
	30	8	5 320	2 410	26 000	17 000	32 000	16101	ZZR	-	2RSR	-	-	-
	32	10	6 800	3 050	22 000	17 000	28 000	6201	ZZ	VV	DDU	N	NR	0,037
15	37	12	9 700	4 200	20 000	16 000	24 000	6301	ZZ	VV	DDU	N	NR	0,060
	24	5	2 070	1 260	28 000	17 000	34 000	6802	ZZ	VV	DD	-	-	0,007
	28	7	4 350	2 260	26 000	17 000	30 000	6902	ZZ	VV	DD	N	NR	0,015
	32	8	5 600	2 830	24 000	-	28 000	16002	-	-	-	-	-	0,027
	32	9	5 600	2 830	24 000	15 000	28 000	6002	ZZ	VV	DDU	N	NR	0,031
	35	11	7 650	3 750	20 000	14 000	24 000	6202	ZZ	VV	DDU	N	NR	0,045
17	42	13	11 400	5 450	17 000	13 000	20 000	6302	ZZ	VV	DDU	N	NR	0,083
	26	5	2 630	1 570	26 000	15 000	30 000	6803	ZZ	VV	DD	-	-	0,007
	30	7	4 600	2 550	24 000	15 000	28 000	6903	ZZ	VV	DDU	N	NR	0,017
	35	8	6 000	3 250	22 000	-	26 000	16003	-	-	-	-	-	0,033
	35	10	6 000	3 250	22 000	13 000	26 000	6003	ZZ	VV	DDU	N	NR	0,041
	40	12	9 550	4 800	17 000	12 000	20 000	6203	ZZ	VV	DDU	N	NR	0,067
20	47	14	13 600	6 650	15 000	11 000	18 000	6303	ZZ	VV	DDU	N	NR	0,113
	32	7	4 000	2 470	22 000	13 000	26 000	6804	ZZ	VV	DD	N	NR	0,017
	37	9	6 400	3 700	19 000	12 000	22 000	6904	ZZ	VV	DDU	N	NR	0,037
	42	8	7 900	4 450	18 000	-	20 000	16004	-	-	-	-	-	0,048
	42	12	9 400	5 000	18 000	11 000	20 000	6004	ZZ	VV	DDU	N	NR	0,068
	47	14	12 800	6 600	15 000	11 000	18 000	6204	ZZ	VV	DDU	N	NR	0,107
22	52	15	15 900	7 900	14 000	10 000	17 000	6304	ZZ	VV	DDU	N	NR	0,145
	44	12	9 400	5 050	17 000	11 000	20 000	60/22	ZZ	VV	DDU	N	NR	0,074
	50	14	12 900	6 800	14 000	9 500	16 000	62/22	ZZ	VV	DDU	N	NR	0,119
56	16	18 400	9 250	13 000	9 500	16 000	63/22	ZZ	VV	DDU	N	NR	0,179	

Single Row Deep Groove Ball Bearings

Bore Diameter 25 – 45 mm



Boundary Dimensions (mm)			Basic Load Ratings (N)		Limiting Speeds (min ⁻¹)			Bearing Numbers					Mass (kg)
d	D	B	C _r	C _{0r}	Grease		Oil	Open	Shielded	Sealed	With Snap Ring Groove	With Snap Ring	approx
					Open Z ZZ V VV	DU DDU	Open Z						
25	37	7	4 500	3 150	18 000	10 000	22 000	6805	ZZ	VV DD	N	NR	0,021
	42	9	7 050	4 550	16 000	10 000	19 000	6905	ZZ	VV DDU	N	NR	0,042
	47	8	8 850	5 600	15 000	-	18 000	16005	-	- -	-	-	0,059
	47	12	10 100	5 850	15 000	9 500	18 000	6005	ZZ	VV DDU	N	NR	0,079
	52	15	14 000	7 850	13 000	9 000	15 000	6205	ZZ	VV DDU	N	NR	0,129
	62	17	20 600	11 200	11 000	8 000	13 000	6305	ZZ	VV DDU	N	NR	0,235
28	52	12	12 500	7 400	14 000	8 500	16 000	60/28	ZZ	VV DDU	N	NR	0,096
	58	16	16 600	9 500	12 000	8 000	14 000	62/28	ZZ	VV DDU	N	NR	0,175
	68	18	26 700	14 000	10 000	7 500	13 000	63/28	ZZ	VV DDU	N	NR	0,287
30	42	7	4 700	3 650	15 000	9 000	18 000	6806	ZZ	VV DD	N	NR	0,024
	47	9	7 250	5 000	14 000	8 500	17 000	6906	ZZ	VV DDU	N	NR	0,052
	55	9	11 200	7 350	13 000	-	15 000	16006	-	- -	-	-	0,087
	55	13	13 200	8 300	13 000	8 000	15 000	6006	ZZ	VV DDU	N	NR	0,116
	62	16	19 500	11 300	11 000	7 500	13 000	6206	ZZ	VV DDU	N	NR	0,199
	72	19	26 700	15 000	9 500	6 700	12 000	6306	ZZ	VV DDU	N	NR	0,345
32	58	13	15 100	9 150	12 000	7 500	14 000	60/32	ZZ	VV DDU	N	NR	0,122
	65	17	20 700	11 600	10 000	7 100	12 000	62/32	ZZ	VV DDU	N	NR	0,225
	75	20	29 900	17 000	9 000	6 300	11 000	63/32	ZZ	VV DDU	N	NR	0,389
35	47	7	4 900	4 100	14 000	7 500	16 000	6807	ZZ	VV DD	N	NR	0,027
	55	10	10 600	7 250	12 000	7 500	15 000	6907	ZZ	VV DDU	N	NR	0,075
	62	9	11 700	8 200	11 000	-	13 000	16007	-	- -	-	-	0,107
	62	14	16 000	10 300	11 000	6 700	13 000	6007	ZZ	VV DDU	N	NR	0,151
	72	17	25 700	15 300	9 500	6 300	11 000	6207	ZZ	VV DDU	N	NR	0,284
	80	21	33 500	19 200	8 500	6 000	10 000	6307	ZZ	VV DDU	N	NR	0,464
40	52	7	6 350	5 550	12 000	6 700	14 000	6808	ZZ	VV DD	N	NR	0,031
	62	12	13 700	10 000	11 000	6 300	13 000	6908	ZZ	VV DDU	N	NR	0,112
	68	9	12 600	9 650	10 000	-	12 000	16008	-	- -	-	-	0,13
	68	15	16 800	11 500	10 000	6 000	12 000	6008	ZZ	VV DDU	N	NR	0,19
	80	18	29 100	17 900	8 500	5 600	10 000	6208	ZZ	VV DDU	N	NR	0,366
	90	23	40 500	24 000	7 500	5 300	9 000	6308	ZZ	VV DDU	N	NR	0,636
45	58	7	6 600	6 150	11 000	6 000	13 000	6809	ZZ	VV DD	N	NR	0,038
	68	12	14 100	10 900	9 500	5 600	12 000	6909	ZZ	VV DDU	N	NR	0,126
	75	10	14 900	11 400	9 000	-	11 000	16009	-	- -	-	-	0,167
	75	16	20 900	15 200	9 000	5 300	11 000	6009	ZZ	VV DDU	N	NR	0,241
	85	19	31 500	20 400	7 500	5 300	9 000	6209	ZZ	VV DDU	N	NR	0,42
	100	25	53 000	32 000	6 700	4 800	8 000	6309	ZZ	VV DDU	N	NR	0,829

Single Row Deep Groove Ball Bearings

Bore Diameter 50 – 75 mm

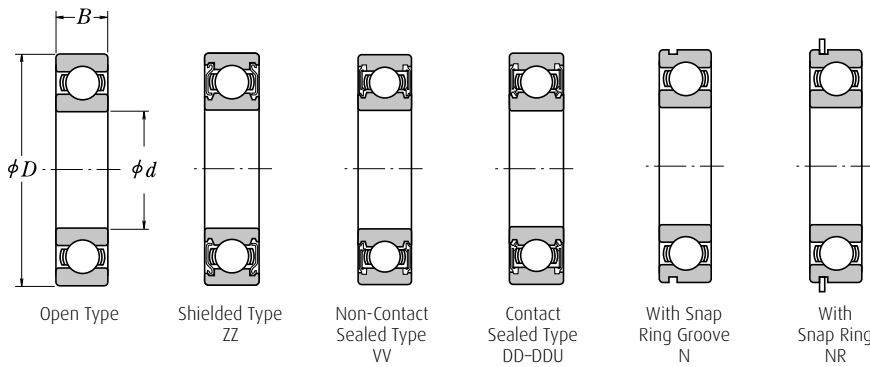

Boundary Dimensions (mm)			Basic Load Ratings (N)		Limiting Speeds (min ⁻¹)			Bearing Numbers					Mass (kg)	
d	D	B	C _r	C _{0r}	Grease		Oil	Open	Shielded	Sealed	With Snap Ring Groove	With Snap Ring	approx	
					Open Z ZZ V VV	DU DDU	Open Z	Open	Shielded	Sealed				
50	65	7	6 400	6 200	9 500	5 300	11 000	6810	ZZ	VV	DDU	N	NR	0,050
	72	12	14 500	11 700	9 000	5 300	11 000	6910	ZZ	VV	DDU	N	NR	0,135
	80	10	15 400	12 400	8 500	-	10 000	16010	-	-	-	-	-	0,175
	80	16	21 800	16 600	8 500	4 800	10 000	6010	ZZ	VV	DDU	N	NR	0,261
	90	20	35 000	23 200	7 100	4 800	8 500	6210	ZZ	VV	DDU	N	NR	0,459
	110	27	62 000	38 500	6 000	4 300	7 500	6310	ZZ	VV	DDU	N	NR	1,06
55	72	9	8 800	8 500	8 500	4 800	10 000	6811	ZZ	VV	DDU	N	NR	0,081
	80	13	16 000	13 300	8 000	4 500	9 500	6911	ZZ	VV	DDU	N	NR	0,189
	90	11	19 400	16 300	7 500	-	9 000	16011	-	-	-	-	-	0,257
	90	18	28 300	21 200	7 500	4 500	9 000	6011	ZZ	VV	DDU	N	NR	0,381
	100	21	43 500	29 300	6 300	4 300	7 500	6211	ZZ	VV	DDU	N	NR	0,619
	120	29	71 500	44 500	5 600	4 000	6 700	6311	ZZ	VV	DDU	N	NR	1,37
60	78	10	11 500	10 900	8 000	4 500	9 500	6812	ZZ	VV	DD	N	NR	0,103
	85	13	19 400	16 300	7 500	4 300	9 000	6912	ZZ	VV	DDU	N	NR	0,192
	95	11	20 000	17 500	7 100	-	8 500	16012	-	-	-	-	-	0,281
	95	18	29 500	23 200	7 100	4 000	8 500	6012	ZZ	VV	DDU	N	NR	0,412
	110	22	52 500	36 000	5 600	3 800	7 100	6212	ZZ	VV	DDU	N	NR	0,783
	130	31	82 000	52 000	5 300	3 600	6 300	6312	ZZ	VV	DDU	N	NR	1,72
65	85	10	11 900	12 100	7 500	4 000	8 500	6813	ZZ	VV	DD	N	NR	0,128
	90	13	17 400	16 100	7 100	4 000	8 500	6913	ZZ	VV	DDU	N	NR	0,218
	100	11	20 500	18 700	6 700	-	8 000	16013	-	-	-	-	-	0,30
	100	18	30 500	25 200	6 700	4 000	8 000	6013	ZZ	VV	DDU	N	NR	0,439
	120	23	57 500	40 000	5 300	3 600	6 300	6213	ZZ	VV	DDU	N	NR	1,0
	140	33	92 500	60 000	4 800	3 400	6 000	6313	ZZ	VV	DDU	N	NR	2,11
70	90	10	12 100	12 700	6 700	3 800	8 000	6814	ZZ	VV	DD	N	NR	0,134
	100	16	23 700	21 200	6 300	3 600	7 500	6914	ZZ	VV	DDU	N	NR	0,349
	110	13	26 800	23 600	6 000	-	7 100	16014	-	-	-	-	-	0,441
	110	20	38 000	31 000	6 000	3 600	7 100	6014	ZZ	VV	DDU	N	NR	0,608
	125	24	62 000	44 000	5 000	3 400	6 300	6214	ZZ	VV	DDU	N	NR	1,09
	150	35	104 000	68 000	4 500	3 200	5 300	6314	ZZ	VV	DDU	N	NR	2,57
75	95	10	12 500	13 900	6 300	3 600	7 500	6815	ZZ	VV	DDU	N	NR	0,149
	105	16	24 400	22 600	6 000	3 400	7 100	6915	ZZ	VV	DDU	N	NR	0,364
	115	13	27 600	25 300	5 600	-	6 700	16015	-	-	-	-	-	0,463
	115	20	39 500	33 500	5 600	3 400	6 700	6015	ZZ	VV	DDU	N	NR	0,649
	130	25	66 000	49 500	4 800	3 200	5 600	6215	ZZ	VV	DDU	N	NR	1,19
	160	37	113 000	77 000	4 300	2 800	5 000	6315	ZZ	VV	DDU	N	NR	3,08

Single Row Deep Groove Ball Bearings

Bore Diameter 80 – 105 mm



Boundary Dimensions (mm)			Basic Load Ratings (N)		Limiting Speeds (min ⁻¹)			Bearing Numbers					Mass (kg)	
d	D	B	C _r	C _{0r}	Grease		Oil	Open	Shielded	Sealed	With Snap Ring Groove	With Snap Ring	approx	
					Open Z ZZ V VV	DU DDU	Open Z							
80	100	10	12 700	14 500	6 000	3 400	7 100	6816	ZZ	VV	DDU	N	NR	0,151
	110	16	25 000	24 000	5 600	3 200	6 700	6916	ZZ	VV	DDU	N	NR	0,391
	125	14	32 000	29 600	5 300	-	6 300	16016	-	-	-	-	-	0,621
	125	22	47 500	40 000	5 300	3 200	6 300	6016	ZZ	VV	DDU	N	NR	0,872
	140	26	72 500	53 000	4 500	3 000	5 300	6216	ZZ	VV	DDU	N	NR	1,42
	170	39	123 000	86 500	4 000	2 800	4 800	6316	ZZ	VV	DDU	N	NR	3,67
85	110	13	18 700	20 000	5 600	3 200	6 700	6817	ZZ	VV	DDU	N	NR	0,263
	120	18	32 000	29 600	5 300	3 000	6 300	6917	ZZ	VV	DDU	N	NR	0,55
	130	14	33 000	31 500	5 000	-	6 000	16017	-	-	-	-	-	0,652
	130	22	49 500	43 000	5 000	3 000	6 000	6017	ZZ	VV	DDU	N	NR	0,918
	150	28	84 000	62 000	4 300	2 800	5 000	6217	ZZ	VV	DDU	N	NR	1,76
	180	41	133 000	97 000	3 800	2 600	4 500	6317	ZZ	VV	DDU	N	NR	4,28
90	115	13	19 000	21 000	5 300	3 000	6 300	6818	ZZ	VV	DDU	N	NR	0,276
	125	18	33 000	31 500	5 000	2 800	6 000	6918	ZZ	VV	DDU	N	NR	0,585
	140	16	41 500	39 500	4 800	-	5 600	16018	-	-	-	-	-	0,873
	140	24	58 000	50 000	4 800	2 800	5 600	6018	ZZ	VV	DDU	N	NR	1,19
	160	30	96 000	71 500	4 000	2 600	4 800	6218	ZZ	VV	DDU	N	NR	2,18
	190	43	143 000	107 000	3 600	2 400	4 300	6318	ZZ	VV	DDU	N	NR	4,98
95	120	13	19 300	22 000	5 000	2 800	6 000	6819	ZZ	VV	DD	N	NR	0,297
	130	18	33 500	33 500	4 800	2 800	5 600	6919	ZZ	VV	DDU	N	NR	0,601
	145	16	43 000	42 000	4 500	-	5 300	16019	-	-	-	-	-	0,904
	145	24	60 500	54 000	4 500	2 600	5 300	6019	ZZ	VV	DDU	N	NR	1,23
	170	32	109 000	82 000	3 800	2 600	4 500	6219	ZZ	VV	DDU	N	NR	2,64
	200	45	153 000	119 000	3 000	2 400	3 600	6319	ZZ	VV	DDU	N	NR	5,76
100	125	13	19 600	23 000	4 800	2 800	5 600	6820	ZZ	VV	DD	N	NR	0,31
	140	20	43 000	42 000	4 500	2 600	5 300	6920	ZZ	VV	DDU	N	NR	0,828
	150	16	42 500	42 000	4 300	-	5 300	16020	-	-	-	-	-	0,945
	150	24	60 000	54 000	4 300	2 600	5 300	6020	ZZ	VV	DDU	N	NR	1,29
	180	34	122 000	93 000	3 600	2 400	4 300	6220	ZZ	VV	DDU	N	NR	3,17
		215	47	173 000	141 000	2 800	2 200	3 400	6320	ZZ	VV	DDU	-	-
105	130	13	19 800	23 900	4 800	2 600	5 600	6821	ZZ	VV	DDU	N	NR	0,324
	145	20	42 500	42 000	4 300	-	5 300	6921	ZZ	VV	-	N	NR	0,856
	160	18	52 000	50 500	4 000	-	4 800	16021	-	-	-	-	-	1,24
	160	26	72 500	66 000	4 000	2 400	4 800	6021	ZZ	VV	DDU	N	NR	1,58
	190	36	133 000	105 000	3 400	2 200	4 000	6221	ZZ	VV	DDU	N	NR	3,79
	225	49	184 000	154 000	2 600	2 000	3 200	6321	ZZ	-	DDU	-	-	8,09

Single Row Deep Groove Ball Bearings

Bore Diameter 110 – 160 mm

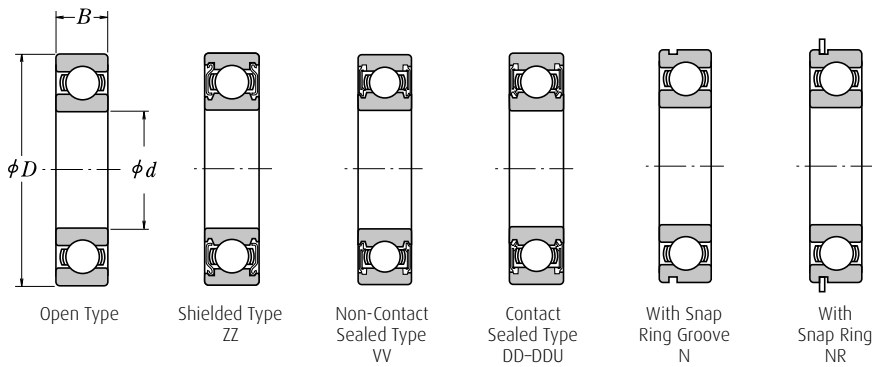

Boundary Dimensions (mm)			Basic Load Ratings (N)		Limiting Speeds (min ⁻¹)			Bearing Numbers					Mass (kg)	
d	D	B	C _r	C _{0r}	Grease		Oil	Open	Shielded	Sealed	With Snap Ring Groove	With Snap Ring	approx	
					Open Z ZZ V VV	DU DDU	Open Z							
110	140	16	28 100	32 500	4 300	2 400	5 300	6822	ZZ	VV	DDU	N	NR	0,497
	150	20	43 500	44 500	4 300	2 400	5 000	6922	ZZ	VV	DDU	N	NR	0,893
	170	19	57 500	56 500	3 800	-	4 500	16022	-	-	-	-	-	1,51
	170	28	85 000	73 000	3 800	2 200	4 500	6022	ZZ	VV	DDU	N	NR	1,94
	200	38	144 000	117 000	2 800	2 200	3 400	6222	ZZ	VV	DDU	N	NR	4,45
	240	50	205 000	179 000	2 400	-	3 000	6322	ZZ	-	-	-	-	9,51
120	150	16	28 900	35 500	4 000	2 200	4 800	6824	ZZ	VV	DD	N	NR	0,537
	165	22	53 000	54 000	3 800	-	4 500	6924	ZZ	-	-	N	NR	1,21
	180	19	56 500	57 500	3 600	-	4 300	16024	-	-	-	-	-	1,6
	180	28	88 000	80 000	3 600	2 200	4 300	6024	ZZ	VV	DDU	N	NR	2,08
	215	40	155 000	131 000	2 600	2 000	3 200	6224	ZZ	VV	DDU	-	-	5,29
	260	55	207 000	185 000	2 200	1 800	2 800	6324	ZZS	-	DDU	-	-	12,5
130	165	18	37 000	44 000	3 600	2 000	4 300	6826	ZZS	VV	DD	N	NR	0,758
	180	24	65 000	67 500	3 400	-	4 000	6926	ZZ	-	-	N	NR	1,57
	200	22	75 500	77 500	3 000	-	3 600	16026	-	-	-	-	-	2,4
	200	33	106 000	101 000	3 000	1 900	3 600	6026	ZZ	-	DDU	N	NR	3,26
	230	40	167 000	146 000	2 400	-	3 000	6226	ZZ	-	-	-	-	5,96
	280	58	229 000	214 000	2 200	-	2 600	6326	ZZS	-	-	-	-	15,2
140	175	18	38 500	48 000	3 400	1 900	4 000	6828	ZZ	VV	DDU	N	NR	0,832
	190	24	66 500	72 000	3 200	-	3 800	6928	ZZS	VV	-	N	NR	1,67
	210	22	77 500	82 500	2 800	-	3 400	16028	-	-	-	-	-	2,84
	210	33	110 000	109 000	2 800	1 800	3 400	6028	ZZ	-	DDU	-	-	3,48
	250	42	166 000	150 000	2 200	1 700	2 800	6228	ZZS	-	DDU	-	-	7,68
	300	62	253 000	246 000	2 000	-	2 400	6328	ZZS	-	-	-	-	18,5
150	190	20	47 500	58 500	3 200	1 800	3 800	6830	ZZ	VV	DDU	N	NR	1,15
	210	28	85 000	90 500	2 600	1 700	3 200	6930	ZZS	-	DDU	-	-	3,01
	225	24	84 000	91 000	2 600	-	3 000	16030	-	-	-	-	-	3,62
	225	35	126 000	126 000	2 600	1 700	3 000	6030	ZZ	VV	DDU	-	-	4,24
	270	45	176 000	168 000	2 000	-	2 600	6230	ZZS	-	-	-	-	10
	320	65	274 000	284 000	1 800	-	2 200	6330	ZZS	-	-	-	-	22,7
160	200	20	48 500	61 000	2 600	1 700	3 200	6832	ZZS	VV	DDU	N	NR	1,23
	220	28	87 000	96 000	2 600	1 600	3 000	6932	ZZS	-	DDU	-	-	2,71
	240	25	99 000	108 000	2 400	-	2 800	16032	-	-	-	-	-	4,2
	240	38	137 000	135 000	2 400	1 600	2 800	6032	ZZ	-	DDU	-	-	5,15
	290	48	185 000	186 000	1 900	-	2 400	6232	ZZS	-	-	-	-	12,8
	340	68	278 000	287 000	1 700	-	2 000	6332	ZZS	-	-	-	-	26,2

Single Row Deep Groove Ball Bearings

Bore Diameter 170 – 240 mm

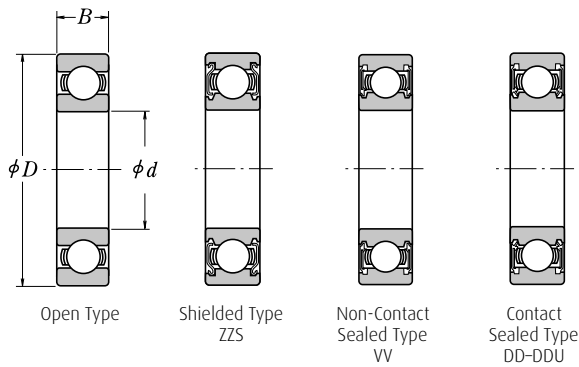

Boundary Dimensions (mm)			Basic Load Ratings (N)		Limiting Speeds (min ⁻¹)			Bearing Numbers			Mass (kg)	
d	D	B	C _r	C _{0r}	Grease		Oil	Open	Shielded	Sealed	approx	
					Open Z ZZ V VV	DU DDU	Open Z					
170	215	22	60 000	75 000	2 600	1 600	3 000	6834	ZZS	VV	DDU	1,86
	230	28	86 000	97 000	2 400	-	2 800	6934	ZZS	-	-	3,34
	260	28	114 000	126 000	2 200	-	2 600	16034	-	-	-	5,71
	260	42	161 000	161 000	2 200	-	2 600	6034	ZZS	VV	-	6,89
	310	52	212 000	224 000	1 800	-	2 200	6234	ZZS	-	-	15,8
	360	72	325 000	355 000	1 600	-	2 000	6334	-	-	-	36,6
180	225	22	60 500	78 500	2 400	-	2 800	6836	-	VV	-	1,98
	250	33	119 000	128 000	2 200	-	2 600	6936	ZZS	-	-	4,16
	280	31	145 000	157 000	2 000	-	2 400	16036	-	-	-	7,5
	280	46	180 000	185 000	2 000	-	2 400	6036	ZZS	VV	-	8,88
	320	52	227 000	241 000	1 700	-	2 000	6236	ZZS	-	-	15,9
	380	75	355 000	405 000	1 500	-	1 800	6336	-	-	-	43,1
190	240	24	73 000	93 500	2 200	-	2 600	6838	-	VV	-	2,53
	260	33	113 000	127 000	2 200	-	2 600	6938	-	-	-	5,18
	290	31	149 000	168 000	2 000	-	2 400	16038	-	-	-	7,78
	290	46	188 000	201 000	2 000	-	2 400	6038	ZZS	-	-	9,39
	340	55	255 000	282 000	1 600	-	2 000	6238	ZZS	-	-	22,3
	400	78	355 000	415 000	1 400	-	1 700	6338	-	-	-	49,7
200	250	24	74 000	98 000	2 200	-	2 600	6840	-	-	-	2,67
	280	38	143 000	158 000	2 000	-	2 400	6940	ZZS	-	-	7,28
	310	34	161 000	180 000	1 900	-	2 200	16040	-	-	-	10
	310	51	207 000	226 000	1 900	-	2 200	6040	ZZS	-	-	12
	360	58	269 000	310 000	1 500	-	1 800	6240	ZZS	-	-	26,7
	420	80	380 000	445 000	1 300	-	1 600	6340	-	-	-	55,3
220	270	24	76 500	107 000	1 900	-	2 400	6844	ZZS	-	-	2,9
	300	38	146 000	169 000	1 800	-	2 200	6944	ZZS	-	-	7,88
	340	37	180 000	217 000	1 600	-	2 000	16044	-	-	-	13,1
	340	56	235 000	271 000	1 700	-	2 000	6044	ZZS	-	-	18,6
	400	65	310 000	375 000	1 300	-	1 600	6244	-	-	-	37,4
	460	88	410 000	520 000	1 200	-	1 500	6344	-	-	-	73,9
240	300	28	98 500	137 000	1 700	-	2 000	6848	-	-	-	4,48
	320	38	154 000	190 000	1 700	-	2 000	6948	ZZS	-	-	8,49
	360	37	196 000	243 000	1 500	-	1 900	16048	-	-	-	13,9
	360	56	244 000	296 000	1 500	-	1 900	6048	-	-	-	19,9
	440	72	340 000	430 000	1 200	-	1 500	6248	-	-	-	50,5
	500	95	470 000	625 000	1 100	-	1 300	6348	-	-	-	94,4

Single Row Deep Groove Ball Bearings

Bore Diameter 260 – 360 mm

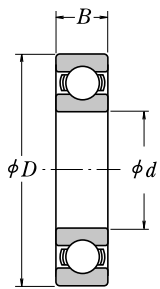

Open Type



Boundary Dimensions (mm)			Basic Load Ratings (N)		Limiting Speeds (min ⁻¹)		Bearing Numbers	Mass (kg)
d	D	B	C _r	C _{0r}	Grease	Oil		approx
260	320	28	101 000	148 000	1 600	1 900	6852	4,84
	360	46	204 000	255 000	1 500	1 800	6952	14
	400	44	237 000	310 000	1 400	1 700	16052	21,1
	400	65	291 000	375 000	1 400	1 700	6052	29,4
	480	80	400 000	540 000	1 100	1 300	6252	67
	540	102	505 000	710 000	1 000	1 200	6352	118
280	350	33	133 000	191 000	1 500	1 700	6856	7,2
	380	46	209 000	272 000	1 400	1 700	6956	15,1
	420	44	243 000	330 000	1 300	1 600	16056	22,7
	420	65	300 000	410 000	1 300	1 600	6056	31,2
	500	80	400 000	550 000	1 000	1 300	6256	70,4
	580	108	570 000	840 000	900	1 100	6356	144
300	380	38	166 000	233 000	1 300	1 600	6860	10,3
	420	56	269 000	370 000	1 300	1 500	6960	23,9
	460	50	285 000	405 000	1 200	1 400	16060	31,5
	460	74	355 000	500 000	1 200	1 400	6060	44,2
	540	85	465 000	670 000	950	1 200	6260	87,8
320	400	38	168 000	244 000	1 300	1 500	6864	10,8
	440	56	266 000	375 000	1 200	1 400	6964	25,3
	480	50	293 000	430 000	1 100	1 300	16064	33,2
	480	74	390 000	570 000	1 100	1 300	6064	46,5
	580	92	530 000	805 000	850	1 100	6264	111
340	420	38	175 000	265 000	1 200	1 400	6868	11,5
	460	56	273 000	400 000	1 100	1 300	6968	26,6
	520	82	440 000	660 000	1 000	1 200	6068	62,3
	620	92	530 000	820 000	800	1 000	6268	129
360	440	38	192 000	290 000	1 100	1 300	6872	11,8
	480	56	280 000	425 000	1 100	1 300	6972	27,9
	540	82	460 000	720 000	950	1 200	6072	65,3
	650	95	555 000	905 000	750	950	6272	145

Single Row Deep Groove Ball Bearings (Inch)

Bore Diameter $\frac{1}{8}$ – $1\frac{1}{4}$ Inch

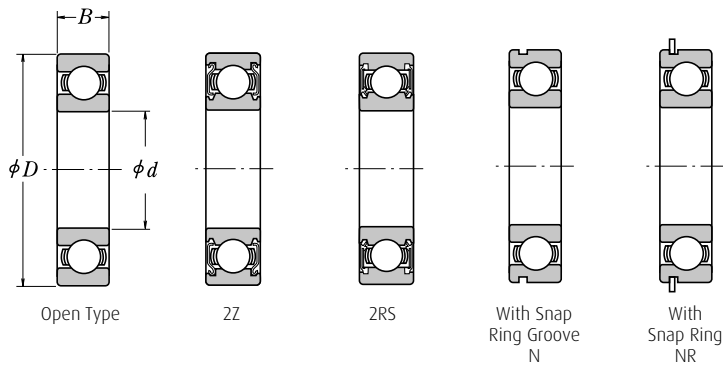

Boundary Dimensions (Inch)			Basic Bearing (N)	Variants						Basic Load Ratings		Limiting Speeds (min ⁻¹)			Mass (kg) approx
d	D	B		Z	-2Z	RS	-2RS	N	NR	C _r	C _{or}	Open Grease Z ZZ	RS 2RS Oil	Open Z	
$\frac{1}{8}$	$\frac{3}{8}$	$\frac{5}{32}$	KLNJ $\frac{1}{8}$							665	230	40 000		48 000	0,0013
$\frac{3}{16}$	$\frac{1}{2}$	$\frac{5}{32}$	KLNJ $\frac{3}{16}$							1 350	490	38 000		45 000	0,0026
$\frac{1}{4}$	$\frac{3}{4}$	$\frac{7}{32}$	KLNJ $\frac{1}{4}$							2 530	1 030	32 000		38 000	0,008
	$\frac{3}{4}$	$\frac{5}{32}$	KLNJ $\frac{1}{4}$							2 530	1 030	32 000	22 000	38 000	0,009
$\frac{3}{8}$	$\frac{7}{8}$	$\frac{7}{32}$	KLNJ $\frac{3}{8}$							3 460	1 410	29 000		36 000	0,011
	$\frac{7}{8}$	$\frac{5}{32}$	KLNJ $\frac{3}{8}$							3 460	1 410	29 000	20 000	36 000	0,012
	$1\frac{1}{2}$	$\frac{5}{16}$	MJ $\frac{3}{8}$							10 100	4 200	20 000		27 000	0,074
$\frac{1}{2}$	$1\frac{1}{8}$	$\frac{1}{4}$	KLNJ $\frac{1}{2}$							4 180	2 010	26 000		32 000	0,019
	$1\frac{1}{8}$	$\frac{5}{16}$	KLNJ $\frac{1}{2}$							4 180	2 010	26 000	17 000	32 000	0,023
	$1\frac{1}{16}$	$\frac{3}{8}$	LJ $\frac{1}{2}$							6 950	3 220	21 000	14 700	28 500	0,037
	$1\frac{1}{8}$	$\frac{5}{8}$	MJ $\frac{1}{2}$							12 100	5 100	18 500	12 900	25 000	0,096
$\frac{5}{8}$	$1\frac{1}{8}$	$\frac{5}{32}$	KLNJ $\frac{5}{8}$							5 800	3 370	22 000		28 000	0,033
	$1\frac{1}{8}$	$\frac{11}{32}$	KLNJ $\frac{5}{8}$							5 800	3 370	22 000	13 000	28 000	0,04
	$1\frac{1}{16}$	$\frac{7}{16}$	LJ $\frac{5}{8}$							10 900	5 000	18 000	12 500	24 000	0,059
	$1\frac{1}{16}$	$\frac{3}{8}$	MJ $\frac{5}{8}$							12 600	5 600	16 500	11 500	22 000	0,117
$\frac{3}{4}$	$1\frac{1}{8}$	$\frac{5}{16}$	KLNJ $\frac{3}{4}$							8 200	4 400	17 000		22 500	0,048
	$1\frac{1}{8}$	$\frac{7}{16}$	KLNJ $\frac{3}{4}$							8 200	4 400	17 000		22 500	0,066
	$1\frac{1}{8}$	$\frac{9}{16}$	LJ $\frac{3}{4}$							14 200	6 700	15 500	10 800	21 000	0,109
	2	$\frac{11}{16}$	MJ $\frac{3}{4}$							16 500	7 850	14 700	10 300	20 000	0,156
$\frac{7}{8}$	$1\frac{1}{8}$	$\frac{3}{8}$	KLNJ $\frac{7}{8}$							12 000	6 400	14 800		20 000	0,078
	$1\frac{1}{8}$	$\frac{1}{2}$	KLNJ $\frac{7}{8}$							12 000	6 400	14 800	10 200	20 000	0,102
	2	$\frac{9}{16}$	LJ $\frac{7}{8}$							14 400	7 000	14 300	10 000	19 500	0,116
	$2\frac{1}{4}$	$\frac{11}{16}$	MJ $\frac{7}{8}$							19 200	9 400	13 300	9 300	18 000	0,197
1	2	$\frac{3}{8}$	KLNJ1							11 800	7 200	13 600		18 500	0,085
	2	$\frac{1}{2}$	KLNJ1							11 800	7 200	13 600	9 500	18 500	0,112
	$2\frac{1}{4}$	$\frac{5}{8}$	LJ1							18 600	9 700	12 700	8 900	17 000	0,169
	$2\frac{1}{2}$	$\frac{3}{4}$	MJ1							22 100	11 000	12 200	8 500	16 500	0,262
$1\frac{1}{8}$	$2\frac{1}{8}$	$\frac{3}{8}$	KLNJ $1\frac{1}{8}$							11 700	7 300	13 000		17 500	0,088
	$2\frac{1}{2}$	$\frac{5}{8}$	LJ $1\frac{1}{8}$							20 200	11 300	11 700	8 200	15 500	0,219
	$2\frac{9}{16}$	$\frac{11}{16}$	MJ $1\frac{1}{8}$							30 800	16 600	10 800	7 500	14 500	0,347
$1\frac{1}{4}$	$2\frac{1}{4}$	$\frac{3}{8}$	KLNJ $1\frac{1}{4}$							12 800	8 700	11 900		16 000	0,096
	$2\frac{1}{4}$	$\frac{1}{2}$	KLNJ $1\frac{1}{4}$							12 800	8 700	11 900		16 000	0,128
	$2\frac{3}{4}$	$\frac{11}{16}$	LJ $1\frac{1}{4}$							27 700	15 000	10 600	7 400	14 400	0,276
	$3\frac{1}{8}$	$\frac{7}{8}$	MJ $1\frac{1}{4}$							37 700	19 600	9 800	6 800	13 200	0,476

Single Row Deep Groove Ball Bearings (Inch)

Bore Diameter $1\frac{3}{8}$ – 3 Inch

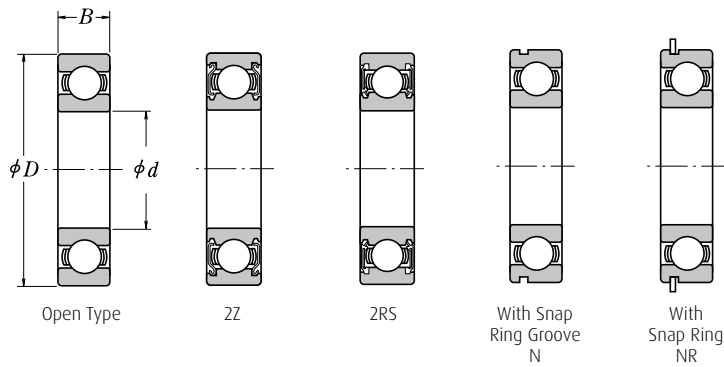

Boundary Dimensions (Inch)			Basic Bearing (N)	Variants						Basic Load Ratings		Limiting Speeds (min ⁻¹)			Mass (kg) approx
d	D	B		Z	-Z	RS	-2RS	N	NR	C _r	C _{0r}	Grease		Oil	
												Open Z ZZ	RS 2RS	Open Z	
1 $\frac{3}{8}$	2 $\frac{1}{2}$	7 $\frac{1}{16}$	KLNJ1 $\frac{3}{8}$							14 400	9 360	11 100		14 900	0,134
	2 $\frac{7}{16}$	9 $\frac{1}{16}$	XLJ1 $\frac{3}{8}$							16 600	10 300	11 200		15 000	0,194
	3	7 $\frac{1}{16}$	LJ1 $\frac{3}{8}$	•	•	•	•	•	•	30 200	17 500	9 800	6 800	13 200	0,333
	3 $\frac{1}{2}$	7 $\frac{1}{16}$	MJ1 $\frac{3}{8}$	•	•	•	•	•	•	45 300	24 000	8 800	6 200	11 900	0,608
1 $\frac{1}{2}$	2 $\frac{3}{8}$	7 $\frac{1}{16}$	KLNJ1 $\frac{1}{2}$							15 000	10 300	10 300		13 900	0,142
	2 $\frac{1}{16}$	9 $\frac{1}{16}$	XLJ1 $\frac{1}{2}$							14 300	9 500	10 200		13 800	0,202
	3 $\frac{1}{4}$	3 $\frac{1}{4}$	LJ1 $\frac{1}{2}$	•	•	•	•	•	•	34 800	20 000	9 000	6 300	12 200	0,418
	3 $\frac{3}{4}$	5 $\frac{1}{16}$	MJ1 $\frac{1}{2}$	•	•	•	•	•	•	49 500	26 700	8 200	5 700	11 000	0,753
1 $\frac{5}{8}$	2 $\frac{7}{8}$	9 $\frac{1}{16}$	XLJ1 $\frac{5}{8}$							14 900	10 500	4 700		9 400	0,276
	3 $\frac{1}{2}$	3 $\frac{1}{4}$	LJ1 $\frac{5}{8}$	•	•	•	•	•	•	38 700	22 100	8 400	5 900	11 300	0,481
	4	5 $\frac{1}{16}$	MJ1 $\frac{5}{8}$	•	•			•	•	55 000	32 000	7 700		10 300	0,857
1 $\frac{3}{4}$	3	9 $\frac{1}{16}$	XLJ1 $\frac{3}{4}$							21 800	15 100	9 100		12 300	0,238
	3 $\frac{3}{4}$	1 $\frac{3}{16}$	LJ1 $\frac{3}{4}$	•	•	•	•	•	•	42 700	24 800	7 800	5 500	10 600	0,594
	4 $\frac{1}{4}$	1 $\frac{1}{16}$	MJ1 $\frac{3}{4}$	•	•			•	•	59 500	34 700	7 100		9 600	1,06
1 $\frac{7}{8}$	3 $\frac{3}{16}$	5 $\frac{1}{16}$	XLJ1 $\frac{7}{8}$							22 700	16 600	8 300		11 200	0,297
	4	1 $\frac{3}{16}$	LJ1 $\frac{7}{8}$	•	•			•	•	50 500	31 200	7 200		9 800	0,708
	4 $\frac{1}{2}$	1 $\frac{1}{16}$	MJ1 $\frac{7}{8}$					•	•	69 000	41 000	6 600		8 900	1,22
2	3 $\frac{5}{16}$	5 $\frac{1}{16}$	XLJ2							22 700	16 600	8 300		11 200	0,317
	4	1 $\frac{3}{16}$	LJ2	•	•			•	•	50 500	31 200	7 200		9 800	0,667
	4 $\frac{1}{2}$	1 $\frac{1}{16}$	MJ2					•	•	69 000	41 000	6 600		8 900	1,17
2 $\frac{1}{4}$	3 $\frac{5}{16}$	5 $\frac{1}{16}$	XLJ2 $\frac{1}{4}$							29 400	21 300	7 600		10 300	0,338
	4 $\frac{1}{2}$	7 $\frac{1}{16}$	LJ2 $\frac{1}{4}$	•	•			•	•	60 000	36 400	6 400		8 600	0,885
	5	1 $\frac{1}{4}$	MJ2 $\frac{1}{4}$					•	•	85 000	51 500	5 900		8 000	1,6
2 $\frac{1}{2}$	3 $\frac{7}{8}$	7 $\frac{1}{16}$	XLJ2 $\frac{1}{2}$							31 800	25 200	6 700		9 000	0,421
	5	5 $\frac{1}{16}$	LJ2 $\frac{1}{2}$					•	•	65 500	42 600	5 700		7 700	1,22
	5 $\frac{1}{2}$	1 $\frac{1}{4}$	MJ2 $\frac{1}{2}$					•	•	96 500	60 000	5 300		7 100	2,04
2 $\frac{3}{4}$	4 $\frac{1}{8}$	7 $\frac{1}{16}$	XLJ2 $\frac{3}{4}$							24 500	21 300	3 100		6 300	0,535
	5 $\frac{1}{4}$	5 $\frac{1}{16}$	LJ2 $\frac{3}{4}$							70 000	48 000	5 300		7 200	1,33
	6 $\frac{1}{4}$	1 $\frac{3}{8}$	MJ2 $\frac{3}{4}$							118 000	77 000	4 600		6 200	2,89
3	4 $\frac{1}{2}$	3 $\frac{1}{4}$	XLJ3							41 100	33 500	5 800		7 800	0,753
	5 $\frac{3}{4}$	1 $\frac{1}{16}$	LJ3							81 500	57 000	4 800		6 500	1,81
	7	1 $\frac{1}{16}$	MJ3							138 000	96 500	4 000		5 400	4,25

Single Row Deep Groove Ball Bearings (Inch)

Bore Diameter 3¹/₄ – 5¹/₂ Inch



Boundary Dimensions (Inch)			Basic Bearing (N)	Variants						Basic Load Ratings		Limiting Speeds (min ⁻¹)			Mass (kg) approx
d	D	B		Z	-Z	RS	-2RS	N	NR	C _r	C _{0r}	Open Grease Z ZZ	RS 2RS	Open Oil Z	
3 ¹ / ₄	4 ³ / ₄	3 ³ / ₄	XLJ3 ¹ / ₄							30 500	28 300	2 700		5 400	0,807
	6	1 ¹ / ₁₆	LJ3 ¹ / ₄							87 500	62 000	4 500		6 100	1,87
	7 ¹ / ₂	1 ⁹ / ₁₆	MJ3 ¹ / ₄							139 000	99 000	3 800		5 100	4,99
3 ³ / ₈	7 ¹ / ₂	1 ⁹ / ₁₆	MJ3 ³ / ₈							139 000	99 000	3 800		5 100	4,9
3 ¹ / ₂	5	3 ³ / ₄	XLJ3 ¹ / ₂							34 100	31 400	5 000		6 800	0,785
	6 ¹ / ₂	1 ¹ / ₈	LJ3 ¹ / ₂							100 000	72 000	4 200		5 600	2,33
	8 ¹ / ₈	1 ³ / ₄	MJ3 ¹ / ₂							169 000	129 000	3 400		4 600	6,53
3 ³ / ₄	5 ¹ / ₄	3 ³ / ₄	XLJ3 ³ / ₄							40 600	38 500	4 700		6 400	0,844
	6 ³ / ₄	1 ¹ / ₈	LJ3 ³ / ₄							106 000	80 500	3 900		5 300	2,47
	8 ¹ / ₄	1 ³ / ₄	MJ3 ³ / ₄							169 000	129 000	3 400		4 600	6,53
4	5 ⁵ / ₈	7 ⁷ / ₈	XLJ4							41 400	40 500	2 200		4 400	1,15
	7 ¹ / ₄	1 ¹ / ₄	LJ4							120 000	88 500	3 800		5 100	3,18
	8 ¹ / ₂	1 ³ / ₄	MJ4							170 000	132 000	3 200		4 400	6,71
4 ¹ / ₄	6	7 ⁷ / ₈	XLJ4 ¹ / ₄							48 400	48 800	4 100		5 500	1,13
	7 ¹ / ₂	1 ¹ / ₄	LJ4 ¹ / ₄							127 000	104 000	3 500		4 700	3,86
	8 ³ / ₄	1 ³ / ₄	MJ4 ¹ / ₄							171 000	184 000	3 100		4 200	8,16
4 ¹ / ₂	6 ¹ / ₄	7 ⁷ / ₈	XLJ4 ¹ / ₂							55 500	58 800	3 900		5 200	1,14
	8	1 ⁹ / ₁₆	LJ4 ¹ / ₂							147 000	117 000	3 300		4 400	4,67
	9 ³ / ₈	2	MJ4 ¹ / ₂							203 000	168 000	2 800		3 800	10,7
4 ³ / ₄	6 ¹ / ₂	7 ⁷ / ₈	XLJ4 ³ / ₄							57 000	56 700	3 700		5 000	1,21
	8 ¹ / ₄	1 ⁹ / ₁₆	LJ4 ³ / ₄							134 000	107 000	3 100		4 200	4,9
	10	2	MJ4 ³ / ₄							209 000	183 000	2 600		3 500	13,2
5	7	1	XLJ5							68 000	67 000	3 400		4 600	1,68
	9	1 ³ / ₈	LJ5							154 000	133 000	2 700		3 700	6,35
	10	2	MJ5							209 000	183 000	2 600		3 500	12,2
5 ¹ / ₄	7 ¹ / ₄	1	XLJ5 ¹ / ₄							51 000	52 000	1 600		3 200	2,1
5 ¹ / ₂	7 ¹ / ₂	1	XLJ5 ¹ / ₂							57 000	62 500	1 500		3 100	2,2
	9 ¹ / ₂	1 ³ / ₈	LJ5 ¹ / ₂							153 000	146 000	2 500		3 400	6,85
	11	2	MJ5 ¹ / ₂							221 000	202 000	2 300		3 100	14,9

Single Row Deep Groove Ball Bearings (Inch)

Bore Diameter $5\frac{3}{4}$ – $10\frac{1}{2}$ Inch

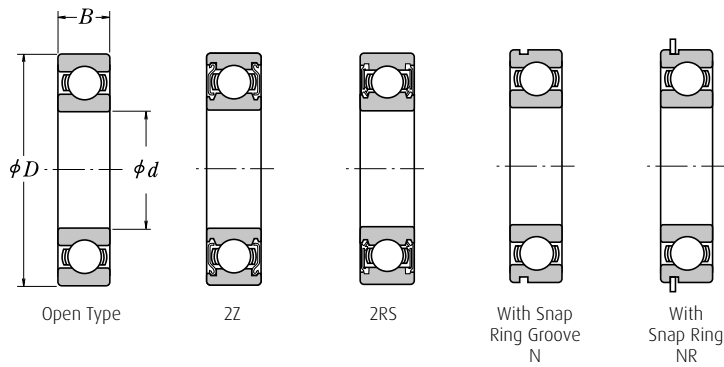

Boundary Dimensions (Inch)			Basic Bearing (N)	Variants						Basic Load Ratings		Limiting Speeds (min ⁻¹)			Mass (kg) approx		
d	D	B		Z	-Z	RS	-2RS	N	NR	C _r	C _{0r}	Grease		Oil			
				Z	-Z	RS	-2RS	N	NR			Open Z	ZZ	RS	2RS	Open Z	
5¾	7¾	1	XLJ5¾							53 500	57 000	1 500				3 000	2,29
6	8	1	XLJ6							54 500	99 500	1 400				2 800	2,37
	10½	1¾	LJ6							180 000	167 000	2 300				3 100	9,48
	12	2¼	MJ6							259 000	251 000	2 100				2 800	19,5
6½	8¾	1½	XLJ6½							66 000	72 000	1 300				2 600	3,13
	11	1¾	LJ6½							188 000	183 000	2 100				2 900	10,2
	13	2½	MJ6½							286 000	289 000	1 900				2 500	26,5
7	9½	1¼	XLJ7							77 500	85 500	1 200				2 300	4,23
	12	1¾	LJ7							221 000	224 000	1 900				2 600	14,1
	13½	2½	MJ7							306 000	326 000	1 700				2 400	27,5
7½	10	1¼	XLJ7½							79 000	89 000	1 100				2 200	4,5
	12½	1¾	LJ7½							231 000	245 000	1 800				2 400	14,5
	14½	2¾	MJ7½							340 000	371 000	1 600				2 200	35,4
8	10¾	1¾	XLJ8							94 500	108 000	1 000				2 000	5,81
	13	1¾	LJ8							230 000	247 000	1 700				2 300	15,9
	15	2¾	MJ8							366 000	377 000	1 500				2 000	36,5
8½	11½	1½	XLJ8½							108 000	123 000	900				1 800	7,44
	14	2	LJ8½							263 000	292 000	1 500				2 100	21,1
	16	3	MJ8½							396 000	442 000	1 400				1 800	47,2
9	12	1½	XLJ9							110 000	128 000	850				1 700	7,85
	14½	2	LJ9							275 000	318 000	1 500				2 000	22
	17	3	MJ9							400 000	495 000	1 200				1 600	53,1
9½	12¾	1¾	XLJ9½							127 000	150 000	800				1 600	9,53
	15½	2	LJ9½							287 000	346 000	1 400				1 800	22,7
10	13¾	1¾	XLJ10							130 000	157 000	750				1 500	9,89
	15¾	2	LJ10							285 000	350 000	1 300				1 700	25,5
	18½	3¼	MJ10							424 000	588 000	1 100				1 500	66,7
10½	14	1¾	XLJ10½							145 000	174 000	700				1 400	12,5
	16¾	2¼	LJ10½							338 000	433 000	1 200				1 600	32,5

Single Row Deep Groove Ball Bearings (Inch)

Bore Diameter 11 – 19 Inch



Boundary Dimensions (Inch)			Basic Bearing (N)	Variants						Basic Load Ratings		Limiting Speeds (min ⁻¹)			Mass (kg) approx
d	D	B		Z	-Z	RS	-2RS	N	NR	C _r	C _{0r}	Grease		Oil	
												Open Z ZZ	RS 2RS	Open Z	
11	14½	1¾	XLJ11							148 000	182 000	650		1 300	13,3
	17½	2¼	LJ11							335 000	437 000	1 100		1 500	36,1
	20	3½	MJ11							480 000	580 000	1 000		1 400	82,5
11½	15¾	1⅞	XLJ11½							212 000	266 000	600		1 200	15,9
	18	2⅞	LJ11½							371 000	499 000	1 100		1 400	38,5
12	16	2	XLJ12							190 000	238 000	550		1 100	18,6
	18½	2⅞	LJ12							388 000	523 000	1 000		1 400	44,5
	21½	3¾	MJ12							557 000	781 000	900		1 200	99,8
12½	16½	2	XLJ12½							188 000	237 000	550		1 100	19,4
	19	2⅞	LJ12½							405 000	568 000	950		1 300	43,7
13	17½	2¼	XLJ13							218 000	289 000	500		1 000	25,9
	20	2¾	LJ13							420 000	593 000	900		1 200	51,7
13½	18	2¼	XLJ13½							222 000	290 000	1 000		1 300	27,8
	20¾	2¾	LJ13½							438 000	629 000	850		1 200	56,1
14	18½	2¼	XLJ14							222 000	290 000	900		1 800	31
	21½	2⅞	LJ14							456 000	650 000	800		1 100	61,6
14½	19½	2½	XLJ14½							299 000	434 000	440		850	34,8
	22	3	LJ14½							476 000	723 000	800		1 100	67,2
15	20	2½	XLJ15							297 000	434 000	850		1 100	34,4
	22½	3	LJ15							474 000	727 000	750		1 000	67,8
16	21½	2¾	XLJ16							323 000	494 000	750		1 000	44,9
	23¾	3¼	LJ16							511 000	811 000	700		950	80,1
17	22½	2¾	XLJ17							329 000	515 000	700		950	47,3
18	24	3	XLJ18							410 000	488 000	700		900	61,6
19	25½	3¼	XLJ19							410 000	688 000	600		800	73,7

Extra Small Ball Bearings

Bore Diameter 3 – 9 mm

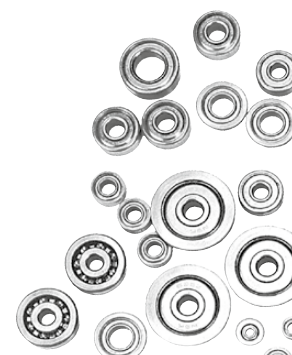
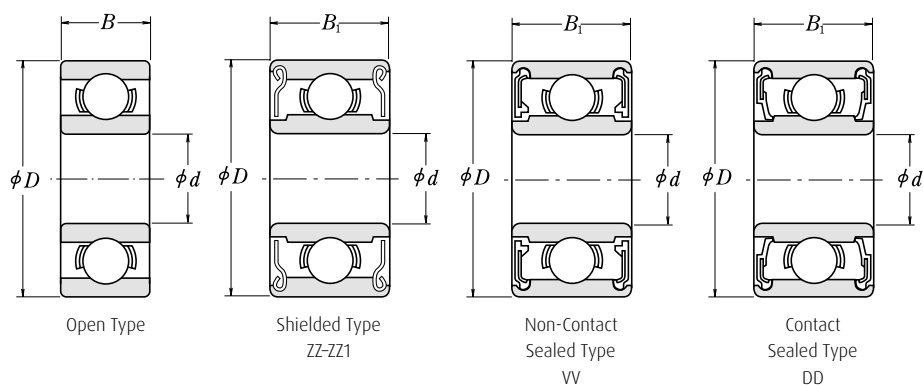

Boundary Dimensions (mm)				Basic Load Ratings (N)		Limiting Speeds (min ⁻¹)			Bearing Numbers				Mass (kg)
d	D	B	B ₁	C _r	C _{0r}	Grease		Oil	Open	Shielded	Sealed		approx
						Open ZZ VV	DU DDU	Open Z			VV	DD	
3	7	2	3	390	130	63 000		75 000	683 A	683 AZZ	-	-	0,00032
	8	3	4	560	179	60 000		67 000	693	693 ZZ	-	-	0,00061
	9	3	5	570	187	56 000		67 000	603	603 ZZ	-	-	0,00087
	10	4	4	630	218	50 000		60 000	623	623 ZZ	-	-	0,00165
	13	5	5	1 300	485	40 000		48 000	633	633 ZZ	-	-	0,00338
4	9	2,5	4	640	225	53 000		63 000	684 A	684 AZZ	-	-	0,00063
	11	4	4	960	345	48 000		56 000	694	694 ZZ	-	-	0,0017
5	11	3	5	715	281	45 000	-	53 000	685	685 ZZ	-	-	0,0012
	13	4	4	1 080	430	43 000	40 000	50 000	695	695 ZZ	VV	DD	0,00245
	14	5	5	1 330	505	40 000	38 000	50 000	605	605 ZZ	-	DD	0,00354
	16	5	5	1 730	670	36 000	32 000	43 000	625	625 ZZ1	VV	DD	0,00495
	19	6	6	2 340	885	32 000	30 000	40 000	635	635 ZZ1	VV	DD	0,00856
6	13	3,5	5	1 080	440	40 000	38 000	50 000	686 A	686 AZZ	VV	DD	0,00191
	15	5	5	1 730	670	40 000	36 000	45 000	696	696 ZZ1	VV	DD	0,00388
	17	6	6	2 260	835	38 000	34 000	45 000	606	606 ZZ	VV	DD	0,00597
	19	6	6	2 340	885	32 000	30 000	40 000	626	626 ZZ1	VV	DD	0,00815
	22	7	7	3 300	1 370	30 000	28 000	36 000	636	636 ZZ	VV	DD	0,014
7	14	3,5	5	1 170	510	40 000	34 000	45 000	687	687 ZZ1	VV	DD	0,00213
	17	5	5	1 610	710	36 000	28 000	43 000	697	697 ZZ1	VV	DD	0,00526
	19	6	6	2 340	885	36 000	32 000	43 000	607	607 ZZ1	VV	DD	0,00767
	22	7	7	3 300	1 370	30 000	28 000	36 000	627	627 ZZ	VV	DD	0,0127
	26	9	9	4 550	1 970	28 000	22 000	34 000	637	637 ZZ1	VV	DD	0,0240
8	16	4	5	1 610	710	36 000	28 000	43 000	688 A	688 AZZ1	VV	DD	0,00312
	19	6	6	2 240	910	36 000	28 000	43 000	698	698 ZZ	VV	DD	0,00723
	22	7	7	3 300	1 370	34 000	28 000	40 000	608	608 ZZ	VV	DD	0,0121
	24	8	8	3 350	1 430	28 000	24 000	34 000	628	628 ZZ	VV	DD	0,0172
	28	9	9	4 550	1 970	28 000	22 000	34 000	638	638 ZZ1	VV	DD	0,0283
9	17	4	5	1 330	665	36 000	24 000	43 000	689	689 ZZ1	VV	DD	0,00353
	20	6	6	1 720	840	34 000	24 000	40 000	699	699 ZZ1	VV	DD	0,00845
	24	7	7	3 350	1 430	32 000	24 000	38 000	609	609 ZZ	VV	DD	0,0145
	26	8	8	4 550	1 970	28 000	22 000	34 000	629	629 ZZ	VV	DD	0,0195
	30	10,0	10	5 100	2 390	24 000	-	30 000	639	639 ZZ	VV	-	0,0365

Maximum Type Ball Bearings

Bore Diameter 25 – 110 mm

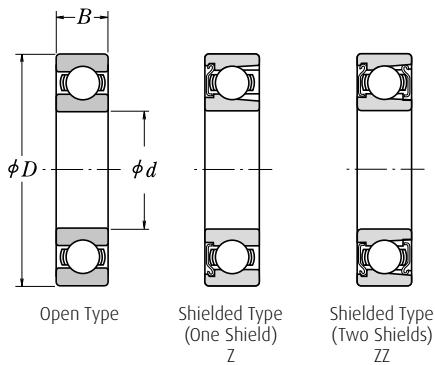

Boundary Dimensions (mm)			Basic Load Ratings (N)		Limiting Speeds (min ⁻¹)		Bearing Numbers			Mass (kg)
d	D	B	C _r	C _{0r}	Grease	Oil	Open	With One Shielded	With Two Shields	approx
					Open Z ZZ	Open Z				
25	52	15	14 400	10 500	12 000	15 000	BL 205	BL 205 Z	BL 205 ZZ	0,133
	62	17	21 500	15 500	11 000	13 000	BL 305	BL 305 Z	BL 305 ZZ	0,246
30	62	16	21 000	16 300	10 000	12 000	BL 206	BL 206 Z	BL 206 ZZ	0,215
	72	19	27 900	20 700	9 000	11 000	BL 306	BL 306 Z	BL 306 ZZ	0,364
35	72	17	27 800	22 100	9 000	11 000	BL 207	BL 207 Z	BL 207 ZZ	0,307
	80	21	37 000	29 100	8 000	9 500	BL 307	BL 307 Z	BL 307 ZZ	0,486
40	80	18	35 500	28 800	8 000	9 500	BL 208	BL 208 Z	BL 208 ZZ	0,394
	90	23	46 500	36 000	7 500	9 000	BL 308	BL 308 Z	BL 308 ZZ	0,685
45	85	19	37 000	32 000	7 500	9 000	BL 209	BL 209 Z	BL 209 ZZ	0,449
	100	25	55 500	44 000	6 300	8 000	BL 309	BL 309 Z	BL 309 ZZ	0,883
50	90	20	39 000	35 000	6 700	8 500	BL 210	BL 210 Z	BL 210 ZZ	0,504
	110	27	65 000	52 500	6 000	7 100	BL 310	BL 310 Z	BL 310 ZZ	1,16
55	100	21	48 000	44 000	6 300	7 500	BL 211	BL 211 Z	BL 211 ZZ	0,667
	120	29	75 000	61 500	5 600	6 700	BL 311	BL 311 Z	BL 311 ZZ	1,49
60	110	22	58 000	54 000	5 600	6 700	BL 212	BL 212 Z	BL 212 ZZ	0,856
	130	31	85 500	71 500	5 000	6 000	BL 312	BL 312 Z	BL 312 ZZ	1,88
65	120	23	63 500	60 000	5 300	6 300	BL 213	BL 213 Z	BL 213 ZZ	1,09
	140	33	103 000	89 500	4 800	5 600	BL 313	BL 313 Z	BL 313 ZZ	2,36
70	125	24	69 000	66 000	5 000	6 000	BL 214	BL 214 Z	BL 214 ZZ	1,19
	150	35	115 000	102 000	4 300	5 300	BL 314	BL 314 Z	BL 314 ZZ	2,87
75	130	25	72 000	72 000	4 500	5 600	BL 215	BL 215 Z	BL 215 ZZ	1,29
	160	37	126 000	116 000	4 000	5 000	BL 315	BL 315 Z	BL 315 ZZ	3,43
80	140	26	84 000	85 000	4 300	5 300	BL 216	BL 216 Z	BL 216 ZZ	1,61
	170	39	136 000	130 000	3 800	4 500	BL 316	BL 316 Z	BL 316 ZZ	4,08
85	150	28	93 000	93 000	4 000	5 000	BL 217	BL 217 Z	BL 217 ZZ	1,97
	180	41	147 000	145 000	3 600	4 300	BL 317	BL 317 Z	BL 317 ZZ	4,77
90	160	30	107 000	107 000	3 800	4 500	BL 218	BL 218 Z	BL 218 ZZ	2,43
	190	43	158 000	161 000	3 400	4 000	BL 318	BL 318 Z	BL 318 ZZ	5,45
95	170	32	121 000	123 000	3 600	4 300	BL 219	BL 219 Z	BL 219 ZZ	2,95
	200	45	169 000	178 000	2 800	3 600	BL 319	BL 319 Z	BL 319 ZZ	6,4
100	180	34	136 000	140 000	3 400	4 000	BL 220	BL 220 Z	BL 220 ZZ	3,54
105	190	36	148 000	157 000	3 200	3 800	BL 221	BL 221 Z	BL 221 ZZ	4,23
110	200	38	160 000	176 000	2 800	3 400	BL 222	-	-	4,84

Double Row Deep Groove Ball Bearings

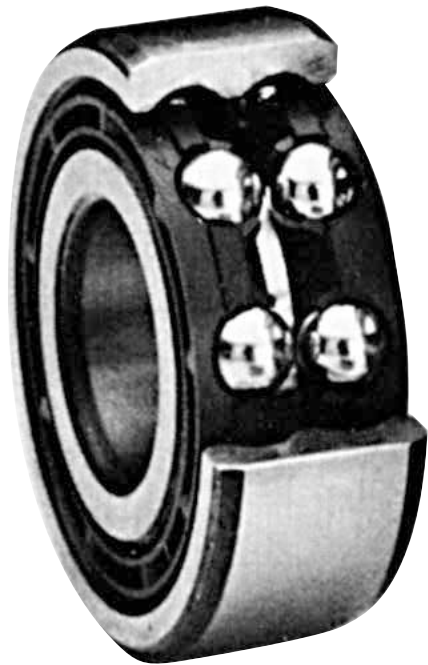

42

Basic Type & Series
4200: Metric, light
4300: Metric, medium

06

Bore Size
(04 and up: multiply last two numbers
by 5 to get bore in mm)

00: 10 mm	04: 20 mm
01: 12 mm	05: 25 mm
02: 15 mm	12: 60 mm
03: 17 mm	20: 100 mm

B

Design
B: Without filling slots

TNG

Cage Material
TNG: Polyamide
J: Steel
M: Brass

C3

Internal Clearance
Blank: Normal
C3: Loose

Radial Internal Clearances

Bore Diameter (mm)		Radial Internal Clearance Groups (µm)			
		CN		C3	
over	include	min.	max.	min.	max.
6	10	2	13	8	23
10	18	3	18	11	25
18	24	5	20	13	28
24	30	5	20	13	28
30	40	6	20	15	33
40	50	6	23	18	36
50	65	8	28	23	43
65	80	10	30	25	51
80	100	12	36	30	58

Interchange

	Description	NSK	SKF	FAG
Part Number	See Interchange list			
Suffixes	Polyamide cage Steel cage Brass cage Normal clearance Loose clearance	TNG J M Blank C3	TN9 J M Blank C3	TVH J M Blank C3

Double Row Deep Groove Ball Bearings

Series 4000, Bore Diameter 10 – 90 mm

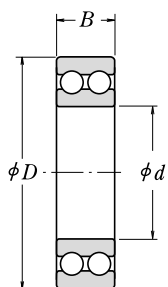

Boundary Dimensions (mm)			Basic Load Ratings (N)		Limiting Speeds (min ⁻¹)		Bearing Numbers	Mass (kg)
d	D	B	C _r	C _{0r}	Grease	Oil		approx
10	30	14,00	9 150	5 200	18 000	24 000	4200	0,049
12	32	14,00	9 300	5 500	16 000	20 000	4201	0,053
15	35	14,00	10 400	6 700	14 000	18 000	4202	0,059
	42	17,00	14 600	9 200	13 000	17 000	4302	0,12
17	40	16,00	14 600	9 500	13 000	18 000	4203	0,09
	47	19,00	19 600	13 200	11 000	17 000	4303	0,16
20	47	18,00	18 000	12 700	10 000	14 000	4204	0,14
	52	21,00	23 200	16 000	9 500	13 000	4304	0,21
25	52	18,00	19 300	14 600	9 000	12 000	4205	0,16
	62	24,00	31 500	22 400	8 000	10 000	4305	0,34
30	62	20,00	26 000	20 800	7 500	9 500	4206	0,26
	72	27,00	40 000	30 500	6 700	8 500	4306	0,5
35	72	23,00	32 000	26 000	6 700	8 500	4207	0,4
	80	31,00	51 000	38 000	6 300	8 000	4307	0,69
40	80	23,00	34 000	30 000	6 000	7 500	4208	0,5
	90	33,00	63 000	48 000	5 600	7 000	4308	0,95
45	85	23,00	36 000	33 500	5 600	7 000	4209	0,54
	100	36,00	72 000	60 000	4 800	6 000	4309	1,25
50	90	23,00	37 500	36 500	5 000	6 300	4210	0,58
	110	40,00	90 000	75 000	4 300	5 300	4310	1,7
55	100	25,00	43 000	43 000	4 500	5 600	4211	0,8
	120	43,00	104 000	90 000	4 000	5 000	4311	2,15
60	110	28,00	57 000	58 500	4 000	5 000	4212	1,1
	130	46,00	120 000	106 000	3 600	4 500	4312	2,65
65	120	31,00	67 000	67 000	3 800	4 800	4213	1,45
	140	48,00	129 000	98 000	3 600	4 500	4313	3,25
70	125	31,00	69 500	73 500	3 600	4 500	4214	1,5
	150	51,00	146 000	114 000	3 200	4 000	4314	3,95
75	130	31,00	73 500	80 000	3 400	4 300	4215	1,6
	160	55,00	170 000	134 000	3 000	3 800	4315	5,38
80	140	33,00	80 000	90 000	3 200	4 000	4216	2
85	150	36,00	93 000	106 000	3 000	3 800	4217	2,55
90	160	40,00	112 000	122 000	2 800	3 600	4218	3,2



Single Row Angular Contact Ball Bearings



Basic Type & Series
 7200: Metric, light
 7300: Metric, medium
 7400: Metric, heavy
 LJ: Inch, light
 MJ: Inch, medium

Contact Angle
 Blank: 20°
 B: 40°

Cage Material
 W: Steel cage
 M: Machined brass
 T85: Polyamide 46

Preload Symbol
 N: Clearance
 Blank: No preload
 L: Light preload
 M: Medium preload

72

10

B

EA

T85

SU

L

Bore Size
 Metric:
 (04 and up: multiply last two numbers by 5 to get bore in mm)
 00: 10 mm
 01: 12 mm
 02: 15 mm
 03: 17 mm
 04: 20 mm

Load Capacity
 Blank: Standard
 EA: Extra Capacity

Other Features
 G: Universal mounting
 SU: Universal mounting

Typical Applications

› Petrochemical Equipment › Gear boxes › Centrifugal pumps › Electrical motors › Fans

Interchange

	Description	NSK	SKF	FAG	NTN	SNR
Part Number	See Interchange list					
Suffixes	40° contact angle	B	B	B	B	B
	Extra capacity	EA	E			
	Polyamide cage	T85	P	TVP	T	A
	Steel cage	W	J		J	
	Machined brass	M	M	MP	L1	
	Universal mounting	G, SU	CB, G	UA, UO	G	G

Single Row Angular Contact Ball Bearings

Series 7000, Bore Diameter 10 – 40 mm

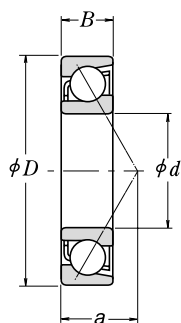

Boundary Dimensions (mm)			Basic Load Ratings (N)		Limiting Speeds (min ⁻¹)		Bearing Numbers	Mass (kg)
d	D	B	C _r	C _{0r}	Grease	Oil		
10	30	9	5 000	2 500	20 000	28 000	7200B	0,032
	35	11	8 750	4 050	18 000	24 000	7300B	0,054
12	32	10	7 450	3 750	18 000	26 000	7201B	0,038
	32	10	7 750	3 750	*	*	7201BEAT85	0,038
	37	12	8 850	4 200	16 000	22 000	7301B	0,062
	37	12	10 500	4 950	*	*	7301BEAT85	0,062
15	35	11	7 950	4 300	16 000	22 000	7202B	0,046
	35	11	9 300	4 800	*	*	7202BEAT85	0,046
	42	13	12 500	6 600	14 000	19 000	7302B	0,086
	42	13	13 600	6 900	*	*	7302BEAT85	0,086
17	40	12	9 950	5 500	14 000	19 000	7203B	0,068
	40	12	11 000	6 100	*	*	7203BEAT85	0,068
	47	14	14 800	8 000	13 000	17 000	7303B	0,118
	47	14	16 000	8 300	*	*	7303BEAT85	0,118
20	47	14	13 300	7 650	12 000	16 000	7204B	0,109
	47	14	14 800	8 150	*	*	7204BEAT85	0,109
	52	15	17 300	9 650	11 000	15 000	7304B	0,15
	52	15	18 900	10 500	*	*	7304BEAT85	0,15
25	52	15	14 800	9 400	10 000	14 000	7205B	0,133
	52	15	16 700	10 200	*	*	7205BEAT85	0,133
	62	17	24 400	14 600	9 000	13 000	7305B	0,241
	62	17	25 900	14 900	*	*	7305BEAT85	0,241
30	62	16	20 500	13 500	8 500	12 000	7206B	0,202
	62	16	22 600	14 300	*	*	7206BEAT85	0,202
	72	19	31 000	19 300	8 000	11 000	7306B	0,354
	72	19	34 500	20 600	*	*	7306BEAT85	0,354
35	72	17	27 100	18 400	7 500	10 000	7207B	0,294
	72	17	31 000	19 600	*	*	7207BEAT85	0,294
	80	21	36 500	24 200	7 100	9 500	7307B	0,474
	80	21	38 500	24 400	*	*	7307BEAT85	0,474
40	80	18	32 000	23 000	6 700	9 000	7208B	0,383
	80	18	36 500	24 500	*	*	7208BEAT85	0,383
	90	23	45 000	30 500	6 300	8 500	7308B	0,648
	90	23	50 500	33 000	*	*	7308BEAT85	0,648

*Please consult NSK about speed limits

Single Row Angular Contact Ball Bearings

Series 7000, Bore Diameter 45 – 85 mm



Boundary Dimensions (mm)			Basic Load Ratings (N)		Limiting Speeds (min ⁻¹)		Bearing Numbers	Mass (kg)
d	D	B	C _r	C _{0r}	Grease	Oil		approx
45	85	19	36 000	26 200	6 300	8 500	7209B	0,421
	85	19	38 500	27 100	*	*	7209BEAT85	0,421
	100	25	58 500	40 000	5 600	7 500	7309B	0,869
	100	25	59 500	39 500	*	*	7309BEAT85	0,869
50	90	20	37 500	28 600	5 600	8 000	7210B	0,477
	90	20	40 000	29 700	*	*	7210BEAT85	0,477
	110	27	68 000	48 000	5 000	6 700	7310B	1,12
	110	27	74 500	50 500	*	*	7310BEAT85	1,12
55	100	21	46 500	36 000	5 300	7 100	7211B	0,627
	100	21	49 000	37 000	*	*	7211BEAT85	0,627
	120	29	79 000	56 500	4 500	6 300	7311B	1,45
	120	29	85 000	58 500	*	*	7311BEAT85	1,45
60	110	22	56 000	44 500	4 800	6 300	7212B	0,815
	110	22	59 000	45 000	*	*	7212BEAT85	0,815
	130	31	90 000	65 500	4 300	5 600	7312B	1,78
	130	31	97 500	68 500	*	*	7312BEAT85	1,78
65	120	23	63 500	52 500	4 300	6 000	7213B	1,05
	120	23	66 500	53 500	*	*	7213BEAT85	1,05
	140	33	102 000	75 500	3 800	5 300	7313B	2,17
	140	33	108 000	77 000	*	*	7313BEAT85	2,17
70	125	24	69 000	58 000	4 000	5 600	7214B	1,14
	125	24	72 000	58 500	*	*	7214BEAT85	1,14
	150	35	114 000	86 000	3 600	5 000	7314B	2,65
	150	35	118 000	87 500	*	*	7314BEAT85	2,65
75	130	25	68 500	58 500	3 800	5 300	7215B	1,22
	130	25	75 000	63 500	*	*	7215BEAT85	1,22
	160	37	125 000	97 500	3 400	4 800	7315B	3,19
	160	37	127 000	98 500	*	*	7315BEAT85	3,19
80	140	26	80 500	69 500	3 600	5 000	7216B	1,49
	140	26	83 500	70 000	*	*	7216BEAT85	1,49
	170	39	135 000	109 000	3 200	4 300	7316B	3,79
	170	39	138 000	110 000	*	*	7316BEAT85	3,79
85	150	28	93 000	81 000	3 400	4 800	7217B	1,87
	180	41	146 000	122 000	3 000	4 000	7317B	4,42

*Please consult NSK about speed limits

Single Row Angular Contact Ball Bearings

Series 7000, Bore Diameter 90 – 200 mm

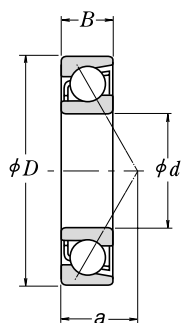

Boundary Dimensions (mm)			Basic Load Ratings (N)		Limiting Speeds (min ⁻¹)		Bearing Numbers	Mass (kg)
d	D	B	C _r	C _{0r}	Grease	Oil		approx
90	160	30	107 000	94 000	3 200	4 300	7218B	2,29
	190	43	156 000	135 000	2 800	3 800	7318B	5,17
95	170	32	116 000	101 000	3 000	4 000	7219B	2,74
	200	45	167 000	149 000	2 600	3 600	7319B	5,98
100	180	34	130 000	114 000	2 800	3 800	7220B	3,28
	215	47	190 000	178 000	2 400	3 400	7320B	7,43
105	190	36	142 000	129 000	2 600	3 600	7221B	3,92
	225	49	191 000	177 000	2 400	3 200	7321B	9,43
110	200	38	154 000	144 000	2 600	3 400	7222B	4,58
	240	50	201 000	197 000	2 200	3 000	7322B	11,2
120	215	40	165 000	162 000	2 400	3 200	7224B	6,26
	260	55	225 000	231 000	2 000	2 800	7324B	14,4
130	230	40	171 000	175 000	2 200	3 000	7226B	7,1
	280	58	250 000	268 000	1 900	2 600	7326B	17,6
140	250	42	197 000	213 000	2 000	2 800	7228B	8,94
	300	62	275 000	310 000	1 700	2 400	7328B	21,6
150	270	45	225 000	254 000	1 800	2 600	7230B	11,2
	320	65	289 000	340 000	1 600	2 200	7330B	25,9
160	290	48	238 000	279 000	1 700	2 400	7232B	14,2
	340	68	315 000	385 000	1 500	2 000	7332B	30,8
170	310	52	266 000	325 000	1 600	2 200	7234B	17,6
	360	72	355 000	445 000	1 400	2 000	7334B	35,6
180	320	52	276 000	350 000	1 500	2 000	7236B	18,4
	380	75	375 000	490 000	1 300	1 800	7336B	42,6
190	340	55	284 000	375 000	1 400	2 000	7238B	22,5
	400	78	410 000	550 000	1 300	1 700	7338B	47,2
200	360	58	305 000	410 000	1 300	1 800	7240B	26,6
	420	80	430 000	600 000	1 200	1 600	7340B	55,3

Single Row Angular Contact Ball Bearings (Inch)

Bore Diameter $\frac{3}{8}$ – 2 Inch



Boundary Dimensions (Inch)			Bearing Numbers	Basic Load Ratings (N)		Limiting Speeds (min ⁻¹)		Mass (kg)
d	D	B		C _r	C _{0r}	Grease	Oil	approx
$\frac{3}{8}$	1½	$\frac{9}{16}$	MJT $\frac{3}{8}$	11 000	4 770	10 300	20 500	0,091
$\frac{1}{2}$	$1\frac{1}{16}$	$\frac{3}{8}$	LJT $\frac{1}{2}$	8 200	3 930	10 600	21 000	0,045
	$1\frac{1}{8}$	$\frac{5}{8}$	MJT $\frac{1}{2}$	12 400	6 040	9 300	18 500	0,113
$\frac{5}{8}$	$1\frac{1}{16}$	$\frac{9}{32}$	LJT $\frac{5}{8}$	12 200	6 280	9 100	18 000	0,059
	$1\frac{1}{8}$	$\frac{5}{8}$	MJT $\frac{5}{8}$	15 900	8 730	8 300	16 500	0,141
$\frac{3}{4}$	$1\frac{1}{8}$	$\frac{9}{16}$	LJT $\frac{3}{4}$	15 900	8 730	7 800	15 500	0,127
	2	$2\frac{1}{32}$	MJT $\frac{3}{4}$	18 900	9 740	7 500	15 000	0,186
$\frac{7}{8}$	2	$\frac{9}{16}$	LJT $\frac{7}{8}$	16 900	9 860	7 200	14 400	0,145
	$2\frac{1}{4}$	$2\frac{1}{32}$	MJT $\frac{7}{8}$	22 100	12 700	6 700	13 400	0,236
1	$2\frac{1}{4}$	$\frac{5}{8}$	LJT1	25 300	14 500	6 500	12 900	0,204
	$2\frac{1}{2}$	$\frac{3}{4}$	MJT1	27 000	16 200	6 100	12 100	0,313
$1\frac{1}{8}$	$2\frac{1}{2}$	$\frac{5}{8}$	LJT $1\frac{1}{8}$	25 300	15 500	5 900	11 700	0,249
	$2\frac{5}{16}$	$\frac{9}{16}$	MJT $1\frac{1}{8}$	36 800	22 000	5 400	10 900	0,422
$1\frac{1}{4}$	$2\frac{3}{4}$	$2\frac{1}{32}$	LJT $1\frac{1}{4}$	27 200	17 000	5 400	10 700	0,336
	$3\frac{1}{8}$	$\frac{7}{8}$	MJT $1\frac{1}{4}$	43 700	27 700	4 900	9 800	0,553
$1\frac{3}{8}$	3	$2\frac{1}{32}$	LJT $1\frac{3}{8}$	37 000	24 200	4 900	9 800	0,408
	$3\frac{1}{2}$	$\frac{7}{8}$	MJT $1\frac{3}{8}$	50 500	31 500	4 400	8 900	0,726
$1\frac{1}{2}$	$3\frac{1}{4}$	$\frac{3}{4}$	LJT $1\frac{1}{2}$	41 600	27 600	4 500	9 100	0,499
	$3\frac{3}{4}$	$2\frac{1}{32}$	MJT $1\frac{1}{2}$	55 000	34 900	4 100	8 300	0,885
$1\frac{5}{8}$	$3\frac{1}{2}$	$\frac{3}{4}$	LJT $1\frac{5}{8}$	43 700	30 600	4 200	8 400	0,594
	4	$2\frac{1}{32}$	MJT $1\frac{5}{8}$	65 500	42 000	3 900	7 700	1,01
$1\frac{3}{4}$	$3\frac{3}{4}$	$\frac{9}{16}$	LJT $1\frac{3}{4}$	51 500	35 300	3 900	7 900	0,726
	$4\frac{1}{4}$	$1\frac{1}{16}$	MJT $1\frac{3}{4}$	71 000	46 100	3 600	7 200	1,29
$1\frac{7}{8}$	4	$\frac{9}{16}$	LJT $1\frac{7}{8}$	56 500	42 000	3 600	7 200	0,835
	$4\frac{1}{2}$	$1\frac{1}{16}$	MJT $1\frac{7}{8}$	82 500	54 400	3 300	6 700	1,46
2	4	$\frac{9}{16}$	LJT2	56 500	42 000	3 600	7 200	0,807
	$4\frac{1}{2}$	$1\frac{1}{16}$	MJT2	82 500	54 400	3 300	6 700	1,41

Single Row Angular Contact Ball Bearings (Inch)

Bore Diameter $2\frac{1}{4}$ – $5\frac{1}{2}$ Inch

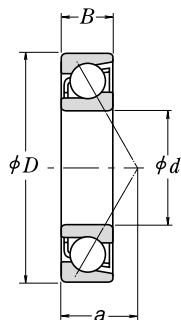

Boundary Dimensions (Inch)			Bearing Numbers	Basic Load Ratings (N)		Limiting Speeds (min ⁻¹)		Mass (kg) approx
d	D	B		C _r	C _{0r}	Grease	Oil	
2¼	4½	7 ⁸ / ₁₆	LJT2¼	65 500	48 200	3 200	6 400	1,09
	5	1¼	MJT2¼	101 000	68 200	3 000	5 900	2
2½	5	1 ⁵ / ₁₆	LJT2½	81 000	63 300	2 900	5 700	1,43
	5½	1¼	MJT2½	114 000	83 500	2 700	5 400	2,44
2¾	5¼	1 ⁵ / ₁₆	LJT2¾	84 500	68 200	2 700	5 400	1,54
	6¼	1 ³ / ₈	MJT2¾	145 000	109 000	2 400	4 700	3,55
3	5¾	1 ¹ / ₁₆	LJT3	94 500	80 400	2 400	4 900	2,11
	7	1 ⁹ / ₁₆	MJT3	171 000	131 000	2 100	4 200	5,17
3¼	6	1 ¹ / ₁₆	LJT3¼	106 000	88 400	2 300	4 600	2,24
	7½	1 ⁹ / ₁₆	MJT3¼	180 000	152 000	1 900	3 800	5,94
3½	7½	1 ⁹ / ₁₆	MJT3½	180 000	152 000	1 900	3 800	5,81
3½	6½	1 ¹ / ₈	LJT3½	114 000	102 000	2 100	4 200	2,78
	8½	1 ¹ / ₈	MJT3½	198 000	172 000	1 800	3 500	7,8
3¾	6¾	1 ¹ / ₈	LJT3¾	122 000	110 000	2 000	4 000	2,91
	8¼	1¾	MJT3¾	208 000	187 000	1 700	3 400	7,76
4	7¼	1¼	LJT4	140 000	128 000	1 800	3 700	3,58
	8½	1¾	MJT4	218 000	204 000	1 600	3 200	8,12
4¼	7½	1¼	LJT4¼	149 000	137 000	1 700	3 500	3,78
	8¾	1¾	MJT4¼	218 000	204 000	1 500	3 100	8,57
4½	8	1 ⁵ / ₁₆	LJT4½	163 000	156 000	1 600	3 200	4,76
	9¾	2	MJT4½	233 000	227 000	1 400	2 900	11,4
4¾	8¼	1 ⁵ / ₁₆	LJT4¾	168 000	166 000	1 500	3 100	4,85
	10	2	MJT4¾	271 000	271 000	1 300	2 600	13,1
5	9	1 ³ / ₈	LJT5	188 000	188 000	1 400	2 800	6,35
	10	2	MJT5	271 000	271 000	1 300	2 600	12,8
5½	9½	1 ³ / ₈	LJT5½	205 000	213 000	1 300	2 600	6,8
	11	2	MJT5½	298 000	322 000	1 200	2 300	15,7

Single Row Angular Contact Ball Bearings (Inch)

Bore Diameter 6 – 15 Inch



Boundary Dimensions (Inch)			Bearing Numbers	Basic Load Ratings (N)		Limiting Speeds (min ⁻¹)		Mass (kg) approx
d	D	B		C _r	C _{0r}	Grease	Oil	
6	10½	1⅝	LJT6	228 000	253 000	1 200	2 300	9,89
	12	2¼	MJT6	332 000	376 000	1 000	2 100	20,9
6½	11	1⅝	LJT6½	233 000	268 000	1 100	2 200	10,7
	13	2½	MJT6½	367 000	429 000	950	1 900	28,1
7	12	1¾	LJT7	262 000	315 000	950	1 900	14,5
	13½	2½	MJT7	384 000	468 000	900	1 800	28,5
7½	12½	1¾	LJT7½	277 000	348 000	900	1 800	15
	14½	2¾	MJT7½	420 000	534 000	800	1 600	36,9
8	13	1¾	LJT8	282 000	365 000	850	1 700	15,9
	15	2¾	MJT8	435 000	578 000	750	1 500	37,6
8½	14	2	LJT8½	323 000	441 000	800	1 600	21,5
	16	3	MJT8½	476 000	677 000	700	1 400	48,5
9	14½	2	LJT9	338 000	455 000	750	1 500	22,7
	17	3	MJT9	567 000	674 000	650	1 300	54,4
9½	15⅝	2	LJT9½	342 000	484 000	700	1 400	24,5
10	15¾	2	LJT10	376 000	546 000	650	1 300	26,5
	18½	3¼	MJT10	552 000	926 000	550	1 100	68,9
10½	16⅝	2¼	LJT10½	372 000	577 000	600	1 200	33,3
11	17½	2¼	LJT11	403 000	648 000	550	1 100	37
	20	3½	MJT11	594 000	919 000	500	1 000	85,3
11½	18	2⅝	LJT11½	400 000	626 000	550	1 100	40,1
12	18½	2⅝	LJT12	460 000	736 000	500	1 000	44,5
	21½	3¾	MJT12	679 000	1 060 000	440	900	104
13	20	2¾	LJT13	498 000	1 060 000	450	900	54,4
14	21½	2⅞	LJT14	525 000	929 000	410	800	65,8
15	22½	3	LJT15	586 000	1 110 000	380	750	71,7

Double Row Angular Contact Ball Bearings



Basic Type & Series

3200: Metric, light
 3300: Metric, medium
 5200: Metric, Conrad, light
 5300: Metric, Conrad, medium

32

Contact Angle

3200/3300 Series

Blank: 32°

B: 25°

5200/5300 Series

Blank: 25°

B

Cage Material

J: Steel cage

M: Machined brass

TNG: Polyamide

TNG

Bore Size

Metric:

(04 and up: multiply last two numbers by 5 to get bore in mm)

00: 10 mm

01: 12 mm

02: 15 mm

03: 17 mm

04: 20 mm

10

Bearing Protection

Blank: Open

2RS: Double contact seal

2ZR: Double shield

2RSR

Internal Clearance

C2: Tight

Blank: Normal

C3: Loose

C4: Extra Loose

C3

Typical Applications

› Petrochemical Equipment › Gear boxes › Centrifugal pumps › Electrical motors › Pumps and Compressors

Radial Internal Clearances

Nominal Bore Diameter (mm)		C2		C0 Normal		C3		C4	
over	include	min.	max.	min.	max.	min.	max.	min.	max.
6	10	1	11	5	21	12	28	25	45
10	18	1	12	6	23	13	31	27	47
18	24	2	14	7	25	16	34	28	48
24	30	2	15	8	27	18	37	30	50
30	40	2	16	9	29	21	40	33	54
40	50	2	18	11	33	23	44	36	58
50	65	3	22	13	36	26	48	40	63
65	80	3	24	15	40	30	54	46	71
80	100	3	26	16	46	35	63	55	83

Units: μm

Interchange

	Description	NSK	SKF	FAG	NTN	SNR
Part Number	See Interchange list					
Suffixes	Polyamide cage	TNG/TNH	TN9	TVP, TVH		G15
	Steel cage	Blank, J	Blank	Blank	Blank	Blank
	Machined brass	M	M	M, MA		M
	2 contact seals	2RS	2RS1	2RSR	LLU	
	2 shields	ZZ	ZZ	ZZR	ZZ	
	Tight Clearance	C2	C2	C2	C2	J20
	Normal Clearance	Blank	Blank	Blank	Blank	Blank
	Loose Clearance	C3	C3	C3	C3	J30

Double Row Angular Contact Ball Bearings

Series 3000, Bore Diameter 10 – 90 mm

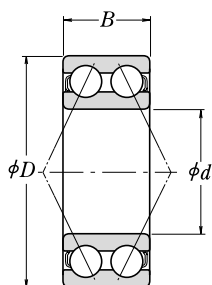

Boundary Dimensions (mm)			Basic Load Ratings (N)		Limiting Speeds (min ⁻¹)		Bearing Numbers	Mass (kg)
d	D	B	C _r	C _{0r}	Grease	Oil		approx
10	30	14,00	7 800	4 550	16 000	22 000	3200	0,043
12	32	15,90	10 600	5 850	15 000	20 000	3201	0,051
	37	19,00	14 500	8 200	10 500	11 500	3301	0,09
15	35	15,90	11 800	7 100	14 000	19 000	3202	0,058
	42	19,00	16 300	10 000	11 000	16 000	3302	0,11
17	40	17,50	14 600	9 000	12 000	17 000	3203	0,085
	47	22,20	20 800	12 500	10 000	15 000	3303	0,161
20	47	20,60	19 600	12 500	10 000	15 000	3204	0,139
	52	22,20	23 200	15 000	9 000	13 000	3304	0,197
25	52	20,60	21 200	14 600	8 500	12 000	3205	0,159
	62	25,40	30 000	20 000	7 500	10 000	3305	0,316
30	62	23,80	30 000	21 200	7 000	9 500	3206	0,265
	72	30,20	41 500	28 500	6 300	8 500	3306	0,496
35	72	27,00	39 000	28 500	6 300	8 500	3207	0,412
	80	34,90	51 000	34 500	5 600	7 500	3307	0,664
40	80	30,20	48 000	36 500	5 600	7 500	3208	0,55
	90	36,50	62 000	45 000	5 000	6 700	3308	0,905
45	85	30,20	48 000	37 500	5 000	6 700	3209	0,583
	100	39,70	68 000	51 000	4 500	6 000	3309	1,21
50	90	30,20	51 000	42 500	4 800	6 300	3210	0,632
	110	44,40	81 000	62 000	4 000	5 300	3310	1,6
55	100	33,30	58 500	49 000	4 300	5 600	3211	0,876
	120	49,20	102 000	78 000	3 800	5 000	3311	2,11
60	110	36,50	72 000	61 000	3 800	5 000	3212	1,18
	130	54,00	125 000	98 000	3 400	4 500	3312	2,7
65	120	38,10	80 000	73 500	3 400	4 500	3213	1,52
	140	58,70	150 000	118 000	3 200	4 300	3313	3,39
70	125	39,70	83 000	76 500	3 400	4 500	3214	1,64
	150	63,50	171 500	138 200	3 000	4 000	3314	4,9
75	130	41,30	91 500	85 000	3 200	4 300	3215	1,91
	160	63,50	173 400	145 300	2 800	3 800	3315	5,7
80	140	44,40	98 000	93 000	3 000	4 000	3216	2,45
85	150	49,20	116 000	110 000	2 800	3 800	3217	3,3
90	160	52,40	124 600	120 300	2 600	3 600	3218	4,17

Double Row Angular Contact Ball Bearings

Series 5000, Bore Diameter 10 – 85 mm



Boundary Dimensions (mm)			Basic Load Ratings (N)		Limiting Speeds (min ⁻¹)		Bearing Numbers	Mass (kg)
d	D	B	C _r	C _{0r}	Grease	Oil		approx
10	30	14,3	7 150	3 900	17 000	22 000	5200	0,05
12	32	15,9	10 500	5 800	15 000	20 000	5201	0,06
15	35	15,9	11 700	7 050	13 000	17 000	5202	0,07
	42	19,00	17 600	10 200	11 000	15 000	5302	0,11
17	40	17,5	14 600	9 050	11 000	15 000	5203	0,09
	47	22,2	21 000	12 600	10 000	13 000	5303	0,14
20	47	20,6	19 600	12 400	10 000	13 000	5204	0,12
	52	22,2	24 600	15 000	9 000	12 000	5304	0,23
25	52	20,6	21 300	14 700	8 500	11 000	5205	0,19
	62	25,4	32 500	20 700	7 500	10 000	5305	0,34
30	62	23,8	29 600	21 100	7 100	9 500	5206	0,29
	72	30,2	40 500	28 100	6 300	8 500	5306	0,51
35	72	27,00	39 000	28 700	6 300	8 000	5207	0,43
	80	34,9	51 000	36 000	5 600	7 500	5307	0,79
40	80	30,2	44 000	33 500	5 600	7 100	5208	0,57
	90	36,5	56 500	41 000	5 300	6 700	5308	1,05
45	85	30,2	49 500	38 000	5 000	6 700	5209	0,62
	100	39,7	68 500	51 000	4 500	6 000	5309	1,4
50	90	30,2	53 000	43 500	4 800	6 000	5210	0,67
	110	44,4	81 500	61 500	4 300	5 600	5310	1,95
55	100	33,3	56 000	49 000	4 300	5 600	5211	0,96
	120	49,2	95 000	73 000	3 800	5 000	5311	2,3
60	110	36,5	69 000	62 000	3 800	5 000	5212	1,35
	130	54,00	125 000	98 500	3 400	4 500	5312	3,15
65	120	38,1	76 500	69 000	3 600	4 500	5213	1,65
	140	58,7	142 000	113 000	3 200	4 300	5313	3,85
70	125	39,7	94 000	82 000	3 400	4 500	5214	1,8
	150	63,5	159 000	128 000	3 000	3 800	5314	4,9
75	130	41,3	93 500	83 000	3 200	4 300	5215	1,9
80	140	44,4	99 000	93 000	3 000	3 800	5216	2,5
85	150	49,2	116 000	110 000	2 800	3 600	5217	3,4

Duplex Ball Bearings (4 Contact Points)



QJ	2	10	M
Basic Type & Series QJ200: Metric, light QJ300: Metric, medium QJL: Inch, light QJM: Inch, medium	Contact Angle Standard: 35°	Bore Size Metric: (04 and up: multiply last two numbers by 5 to get bore in mm) 00 : 10 mm 01 : 12 mm 02 : 15 mm 03 : 17 mm 04 : 20 mm Inch: directly indicated	Cage Material M: Machined brass as standard

Typical Applications

› Transmissions › Compressors › Pumps

Duplex Contact Ball Bearings

Series QJ, Bore Diameter 30 – 95 mm

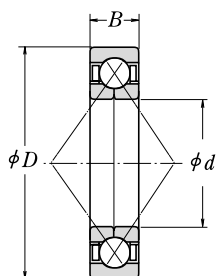

Boundary Dimensions (mm)			Basic Load Ratings (N)		Limiting Speeds (min ⁻¹)		Bearing Numbers	Mass (kg)
d	D	B	C _r	C _{0r}	Grease	Oil		approx
30	62	16,00	31 000	45 000	8 500	12 000	QJ206	0,24
	72	19,00	46 000	63 000	8 000	11 000	QJ306	0,42
35	72	17,00	41 000	61 500	7 500	10 000	QJ207	0,35
	80	21,00	55 000	80 000	7 100	9 500	QJ307	0,57
40	80	18,00	49 000	77 500	6 700	9 000	QJ208	0,45
	90	23,00	67 000	100 000	6 300	8 500	QJ308	0,78
45	85	19,00	55 000	88 500	6 300	8 500	QJ209	0,52
	100	25,00	87 500	133 000	5 600	7 500	QJ309	1,05
50	90	20,00	57 000	97 000	5 600	8 000	QJ210	0,59
	110	27,00	102 000	159 000	5 000	6 700	QJ310	1,35
55	100	21,00	71 000	122 000	5 300	7 100	QJ211	0,77
	120	29,00	118 000	187 000	4 500	6 300	QJ311	1,75
60	110	22,00	85 500	150 000	4 800	6 300	QJ212	0,98
	130	31,00	135 000	217 000	4 300	5 600	QJ312	2,15
65	120	23,00	97 500	179 000	4 300	6 000	QJ213	1,2
	140	33,00	153 000	250 000	3 800	5 300	QJ313	2,7
70	125	24,00	106 000	197 000	4 000	5 600	QJ214	1,3
	150	35,00	172 000	285 000	3 600	5 000	QJ314	3,18
75	130	25,00	110 000	212 000	3 800	5 300	QJ215	1,5
	160	37,00	187 000	320 000	3 400	4 800	QJ315	3,9
80	140	26,00	124 000	236 000	3 600	5 000	QJ216	1,85
	170	39,00	202 000	360 000	3 200	4 300	QJ316	4,6
85	150	28,00	143 000	276 000	3 400	4 800	QJ217	2,2
	180	41,00	218 000	405 000	3 000	4 000	QJ317	5,34
90	160	30,00	164 000	320 000	3 200	4 300	QJ218	2,75
	190	43,00	235 000	450 000	2 800	3 800	QJ318	6,4
95	170	32,00	177 000	340 000	3 000	4 000	QJ219	3,35
	200	45,00	251 000	495 000	2 600	3 600	QJ319	7,4

Duplex Contact Ball Bearings

Series QJ, Bore Diameter 100 – 200 mm

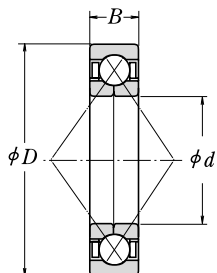

Boundary Dimensions (mm)			Basic Load Ratings (N)		Limiting Speeds (min ⁻¹)		Bearing Numbers	Mass (kg)
d	D	B	C _r	C _{0r}	Grease	Oil		approx
100	180	34,00	199 000	390 000	2 800	3 800	QJ220	4
	215	47,00	300 000	640 000	2 400	3 400	QJ320	9,3
105	190	36,00	217 000	435 000	2 600	3 600	QJ221	4,7
	225	49,00	305 000	640 000	2 400	3 200	QJ321	10,5
110	200	38,00	235 000	490 000	2 600	3 400	QJ222	5,6
	240	50,00	320 000	710 000	2 200	3 000	QJ322	12,5
120	215	40,00	265 000	585 000	2 400	3 200	QJ224	6,9
	260	55,00	360 000	835 000	2 000	2 800	QJ324	15,4
130	230	40,00	274 000	635 000	2 200	3 000	QJ226	7,7
	280	58,00	400 000	970 000	1 900	2 600	QJ326	19
140	250	42,00	315 000	775 000	2 000	2 800	QJ228	9,8
	300	62,00	440 000	1 110 000	1 700	2 400	QJ328	24
150	270	45,00	360 000	925 000	1 800	2 600	QJ230	12
	320	65,00	460 000	1 230 000	1 600	2 200	QJ330	29
160	290	48,00	380 000	1 010 000	1 700	2 400	QJ232	15
	340	68,00	505 000	1 400 000	1 500	2 000	QJ332	31
170	310	52,00	425 000	1 180 000	1 600	2 200	QJ234	19,5
	360	72,00	565 000	1 610 000	1 400	2 000	QJ334	41
180	320	52,00	440 000	1 270 000	1 500	2 000	QJ236	20,5
	380	75,00	595 000	1 770 000	1 300	1 800	QJ336	48
190	340	55,00	455 000	1 360 000	1 400	2 000	QJ238	23
	400	78,00	655 000	1 980 000	1 300	1 700	QJ338	54,5
200	360	58,00	490 000	1 480 000	1 300	1 800	QJ240	27
	420	80,00	690 000	2 180 000	1 200	1 600	QJ340	61,5

Duplex Contact Ball Bearings (Inch)

Series QJ, Bore Diameter 1 – 2 1/4 Inch



Boundary Dimensions (Inch)			Bearing Numbers	Basic Load Ratings (N)		Limiting Speeds (min ⁻¹)		Mass (kg) approx
d	D	B		C _r	C _{0r}	Grease	Oil	
1	2 1/4	5/8	QJL1	15 700	10 900	6 400	12 900	0,218
	2 1/2	3/4	QJM1	28 000	15 600	6 100	12 100	0,327
1 1/8	2 1/2	5/8	QJL1 1/8	17 300	13 100	5 800	11 600	0,263
	2 3/8	3/4	QJM1 1/8	35 200	20 200	5 400	10 900	0,445
1 1/4	2 3/4	1 1/8	QJL1 1/4	30 000	18 100	5 300	10 600	0,363
	3 1/8	7/8	QJM1 1/4	42 900	25 000	4 900	9 800	0,599
1 3/8	3	1 1/8	QJL1 3/8	28 100	21 000	5 000	9 900	0,431
	3 1/2	7/8	QJM1 3/8	51 500	30 700	4 200	8 500	0,771
1 1/2	3 1/4	3/4	QJL1 1/2	37 700	25 100	4 500	9 000	0,522
	3 3/4	5/8	QJM1 1/2	60 500	36 500	4 000	8 000	0,907
1 5/8	3 1/2	3/4	QJL1 5/8	39 500	27 600	4 000	8 000	0,635
	4	5/8	QJM1 5/8	64 500	41 500	3 800	7 600	1,05
1 3/4	3 3/4	1 3/8	QJL1 3/4	44 000	31 200	3 900	7 900	0,78
	4 1/4	1 1/8	QJM1 3/4	56 500	44 000	3 600	7 200	1,34
1 7/8	4	1 3/8	QJL1 7/8	56 000	39 400	3 700	7 400	0,875
	4 1/2	1 1/8	QJM1 7/8	75 500	49 300	3 300	6 600	1,52
2	4	1 3/8	QJL2	56 000	39 400	3 500	7 000	0,826
	4 1/2	1 1/8	QJM2	56 000	49 300	3 300	6 600	1,47
2 1/4	4 1/2	7/8	QJL2 1/4	52 500	41 300	3 100	6 300	1,16
	5	1 1/4	QJM2 1/4	92 500	62 500	3 000	5 900	2,1

Duplex Contact Ball Bearings (Inch)

Series QJ, Bore Diameter 2½ – 6 Inch

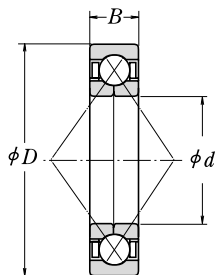

Boundary Dimensions (Inch)			Basic Load Ratings (N)		Limiting Speeds (min ⁻¹)		Bearing Numbers	Mass (kg)
d	D	B	C _r	C _{0r}	Grease	Oil		approx
2½	5	¾	QJL2½	63 500	61 700	2 800	5 600	1,53
	5½	1¼	QJM2½	105 000	79 100	2 700	5 400	2,59
2¾	5¼	¾	QJL2¾	82 000	66 900	2 700	5 400	1,63
	6¼	1⅜	QJM2¾	125 000	102 000	2 300	4 700	3,69
3	5¾	1⅞	QJL3	84 500	79 200	2 400	4 800	2,25
	7	1⅞	QJM3	160 000	126 000	2 100	4 100	5,44
3¼	6	1⅞	QJL3¼	95 000	79 600	2 300	4 600	2,35
	7½	1⅞	QJM3¼	159 000	142 000	1 900	3 800	6,44
3⅝	7½	1⅞	QJM3⅝	159 000	129 000	1 900	3 800	6,21
3½	6½	1⅞	QJL3½	106 000	92 200	2 100	4 200	2,95
	8½	1¾	QJM3½	194 000	170 000	1 800	3 500	8,3
3¾	6¾	1⅞	QJL3¾	108 000	94 000	2 000	4 000	3,08
	8¼	1¾	QJM3¾	194 000	170 000	1 700	3 400	8,16
4	7¼	1¼	QJL4	125 000	114 000	1 800	3 700	3,97
	8½	1¾	QJM4	205 000	188 000	1 600	3 100	9,12
4¼	8¾	1¾	QJM4¼	205 000	190 000	1 500	3 100	9,89
4½	8	1⅞	QJL4½	158 000	149 000	1 600	3 200	5,05
	9¾	2	QJM4½	233 000	222 000	1 400	2 900	12,3
4¾	10	2	QJM4¾	245 000	246 000	1 300	2 600	14
5	10	2	QJM5	245 000	246 000	1 300	2 600	13,5
5½	11	2	QJM5½	268 000	291 000	1 100	2 300	17,2
6	12	2¼	QJM6	314 000	365 000	1 000	2 100	22,1



Self-Aligning Ball Bearings



Bore Size
Metric:
 (04 and up: multiply last two numbers by 5 to get bore in mm)
 00: 10 mm 04: 20 mm
 01: 12 mm 05: 25 mm
 02: 15 mm 12: 60 mm
 03: 17 mm 20: 100 mm
 Inch: directly indicated

Cage Material
 TNG: Polyamide
 J: Pressed Steel

22

06

2RS

TNG

C3

Basic Type & Series

1200: Metric, self-aligning, extra narrow
 1300: Metric, self-aligning, narrow
 2200: Metric, self-aligning, wide
 2300: Metric, self-aligning, extra wide
 NLJ: Inches, self aligning, light
 NMJ: Inches, self aligning, medium

Suffixes

2RS: Double contact seal
 K: Taper bore 1:12
 E: Extra Capacity
 NR: Snap Ring

Internal Clearance

C2: Tight
 Blank: Normal
 C3: Loose
 C4: Extra Loose

Typical Applications

- › Film Processing Equipment › Vertical Spinning Equipment › Vertical Weaving Equipment › Paper Making – Fourdrinier
- › Industrial Countershafts

Radial Internal Clearances

Nominal Bore Diameter (mm)		Clearance in Bearings with Cylindrical Bores										Clearance in Bearings with Tapered Bore									
		C2		CN		C3		C4		C5		C2		CN		C3		C4		C5	
over	include	min.	max.	min.	max.	min.	max.	min.	max.	min.	max.	min.	max.	min.	max.	min.	max.	min.	max.	min.	max.
2,5	6	1	8	5	15	10	20	15	25	21	33	-	-	-	-	-	-	-	-	-	-
6	10	2	9	6	17	12	25	19	33	27	42	-	-	-	-	-	-	-	-	-	-
10	14	2	10	6	19	13	26	21	35	30	48	-	-	-	-	-	-	-	-	-	-
14	18	3	12	8	21	15	28	23	37	32	50	-	-	-	-	-	-	-	-	-	-
18	24	4	14	10	23	17	30	25	39	34	52	7	17	13	26	20	33	28	42	37	55
24	30	5	16	11	24	19	35	29	46	40	58	9	20	15	28	23	39	33	50	44	62
30	40	6	18	13	29	23	40	34	53	46	66	12	24	19	35	29	46	40	59	52	72
40	50	6	19	14	31	25	44	37	57	50	71	14	27	22	39	33	52	45	65	58	79
50	65	7	21	16	36	30	50	45	69	62	88	18	32	27	47	41	61	56	80	73	99
65	80	8	24	18	40	35	60	54	83	76	108	23	39	35	57	50	75	69	98	91	123
80	100	9	27	22	48	42	70	64	96	89	124	29	47	42	68	62	90	84	116	109	144
100	120	10	31	25	56	50	83	75	114	105	145	35	56	50	81	75	108	100	139	130	170
120	140	10	38	30	68	60	100	90	135	125	175	40	68	60	98	90	130	120	165	155	205
140	160	15	44	35	80	70	120	110	161	150	210	45	74	65	110	100	150	140	191	180	240

Units: μm

Interchange

	Description	NSK	SKF	FAG	NTN	SNR
Part Number	See Interchange list					
	Polyamide cage	TNG	TN9	TV		G15
	Steel cage	Blank, J	Blank	Blank	Blank	Blank
	2 contact seals	2RS	2RS1	2RSR	LLU	EE
	Tight Clearance	C2	C2	C2	C2	J20
	Normal Clearance	Blank	Blank	Blank	Blank	Blank
	Loose Clearance	C3	C3	C3	C3	J30
	Tapered bore 1:12	K	K	K	K	K

Double Row Self Aligning Ball Bearings

Bore Diameter 5 – 30 mm

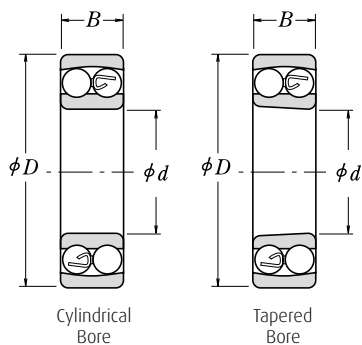

Boundary Dimensions (mm)			Basic Load Ratings (N)		Limiting Speeds (min ⁻¹)		Bearing Numbers		Mass (kg)
d	D	B	C _r	C _{0r}	Grease	Oil	Cylindrical Bore	Tapered Bore ¹⁾	approx
5	19	6	2 530	475	30 000	36 000	135	–	0,009
6	19	6	2 530	475	30 000	36 000	126	–	0,008
7	22	7	2 750	600	26 000	32 000	127	–	0,013
8	22	7	2 750	600	26 000	32 000	108	–	0,016
9	26	8	4 150	895	26 000	30 000	129	–	0,021
10	30	9	5 550	1 190	22 000	28 000	1200	–	0,033
	30	14	7 450	1 590	24 000	28 000	2200	–	0,042
	35	11	7 350	1 620	20 000	24 000	1300	–	0,057
	35	17	9 200	2 010	18 000	22 000	2300	–	0,077
12	32	10	5 700	1 270	22 000	26 000	1201	–	0,039
	32	14	7 750	1 730	22 000	26 000	2201	–	0,048
	37	12	9 650	2 160	18 000	22 000	1301	–	0,066
	37	17	12 100	2 730	17 000	22 000	2301	–	0,082
15	35	11	7 600	1 750	18 000	22 000	1202	–	0,051
	35	14	7 800	1 850	18 000	22 000	2202	–	0,055
	42	13	9 700	2 290	16 000	20 000	1302	–	0,093
	42	17	12 300	2 910	14 000	18 000	2302	–	0,108
17	40	12	8 000	2 010	16 000	20 000	1203	–	0,072
	40	16	9 950	2 420	16 000	20 000	2203	–	0,085
	47	14	12 700	3 200	14 000	17 000	1303	–	0,13
	47	19	14 700	3 550	13 000	16 000	2303	–	0,15
20	47	14	10 000	2 610	14 000	17 000	1204	1204 K	0,12
	47	18	12 800	3 300	14 000	17 000	2204	2204 K	0,133
	52	15	12 600	3 350	12 000	15 000	1304	1304 K	0,165
	52	21	18 500	4 700	11 000	14 000	2304	2304 K	0,193
25	52	15	12 200	3 300	12 000	14 000	1205	1205 K	0,14
	52	18	12 400	3 450	12 000	14 000	2205	2205 K	0,15
	62	17	18 200	5 000	10 000	13 000	1305	1305 K	0,255
	62	24	24 900	6 600	9 500	12 000	2305	2305 K	0,319
30	62	16	15 800	4 650	10 000	12 000	1206	1206 K	0,22
	62	20	15 300	4 550	10 000	12 000	2206	2206 K	0,249
	72	19	21 400	6 300	8 500	11 000	1306	1306 K	0,385
	72	27	32 000	8 750	8 000	10 000	2306	2306 K	0,48

¹⁾ The suffix K represents bearings with tapered bores (1 : 12).

For the dimensions related to adapters, refer to Page B354 on Cat. RB/A/GB/...

Double Row Self Aligning Ball Bearings

Bore Diameter 35 – 70 mm



Boundary Dimensions (mm)			Basic Load Ratings (N)		Limiting Speeds (min ⁻¹)		Bearing Numbers		Mass (kg)
d	D	B	C _r	C _{0r}	Grease	Oil	Cylindrical Bore	Tapered Bore ¹⁾	approx
35	72	17	15 900	5 100	8 500	10 000	1207	1207 K	0,32
	72	23	21 700	6 600	8 500	10 000	2207	2207 K	0,378
	80	21	25 300	7 850	7 500	9 500	1307	1307 K	0,51
	80	31	40 000	11 300	7 100	9 000	2307	2307 K	0,642
40	80	18	19 300	6 500	7 500	9 000	1208	1208 K	0,415
	80	23	22 400	7 350	7 500	9 000	2208	2208 K	0,477
	90	23	29 800	9 700	6 700	8 500	1308	1308 K	0,715
	90	33	45 500	13 500	6 300	8 000	2308	2308 K	0,889
45	85	19	22 000	7 350	7 100	8 500	1209	1209 K	0,465
	85	23	23 300	8 150	7 100	8 500	2209	2209 K	0,522
	100	25	38 500	12 700	6 000	7 500	1309	1309 K	0,955
	100	36	55 000	16 700	5 600	7 100	2309	2309 K	1,2
50	90	20	22 800	8 100	6 300	8 000	1210	1210 K	0,525
	90	23	23 300	8 450	6 300	8 000	2210	2210 K	0,564
	110	27	43 500	14 100	5 600	6 700	1310	1310 K	1,25
	110	40	65 000	20 200	5 000	6 300	2310	2310 K	1,58
55	100	21	26 900	10 000	6 000	7 100	1211	1211 K	0,705
	100	25	26 700	9 900	6 000	7 100	2211	2211 K	0,746
	120	29	51 500	17 900	5 000	6 300	1311	1311 K	1,6
	120	43	76 500	24 000	4 800	6 000	2311	2311 K	2,03
60	110	22	30 500	11 500	5 300	6 300	1212	1212 K	0,90
	110	28	34 000	12 600	5 300	6 300	2212	2212 K	1,03
	130	31	57 500	20 800	4 500	5 600	1312	1312 K	2,03
	130	46	88 500	28 300	4 300	5 300	2312	2312 K	2,57
65	120	23	31 000	12 500	4 800	6 000	1213	1213 K	1,15
	120	31	43 500	16 400	4 800	6 000	2213	2213 K	1,4
	140	33	62 500	22 900	4 300	5 300	1313	1313 K	2,54
	140	48	97 000	32 500	3 800	4 800	2313	2313 K	3,2
70	125	24	35 000	13 800	4 800	5 600	1214	–	1,3
	125	31	44 000	17 100	4 500	5 600	2214	–	1,52
	150	35	75 000	27 700	4 000	5 000	1314	–	3,19
	150	51	111 000	37 500	3 600	4 500	2314	–	3,9

¹⁾ The suffix K represents bearings with tapered bores (1 : 12).

For the dimensions related to adapters, refer to Page B354 on Cat. RB/A/GB/...

Double Row Self Aligning Ball Bearings

Bore Diameter 75 – 110 mm

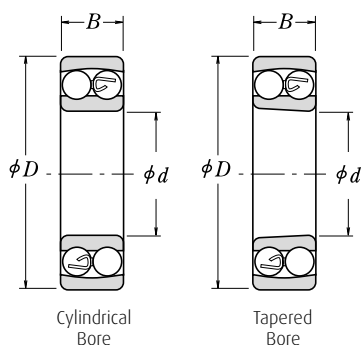

Boundary Dimensions (mm)			Basic Load Ratings (N)		Limiting Speeds (min ⁻¹)		Bearing Numbers		Mass (kg)
d	D	B	C _r	C _{or}	Grease	Oil	Cylindrical Bore	Tapered Bore ¹⁾	approx
75	130	25	39 000	15 700	4 300	5 300	1215	1215 K	1,41
	130	31	44 500	17 800	4 300	5 300	2215	2215 K	1,6
	160	37	80 000	30 000	3 800	4 500	1315	1315 K	3,65
	160	55	125 000	43 000	3 400	4 300	2315	2315 K	4,77
80	140	26	40 000	17 000	4 000	5 000	1216	1216 K	1,73
	140	33	49 000	19 900	4 000	5 000	2216	2216 K	1,97
	170	39	89 000	33 000	3 600	4 300	1316	1316 K	4,31
	170	58	130 000	45 000	3 200	4 000	2316*	2316 K*	5,54
85	150	28	49 500	20 800	3 800	4 500	1217	1217 K	2,09
	150	36	58 500	23 600	3 800	4 800	2217	2217 K	2,48
	180	41	98 500	38 000	3 400	4 000	1317	1317 K	5,13
	180	60	142 000	51 500	3 000	3 800	2317	2317 K	6,56
90	160	30	57 500	23 500	3 600	4 300	1218	1218 K	2,55
	160	40	70 500	28 700	3 600	4 300	2218	2218 K	3,13
	190	43	117 000	44 500	3 200	3 800	1318*	1318 K*	5,94
	190	64	154 000	57 500	2 800	3 600	2318	2318 K	7,76
95	170	32	64 000	27 100	3 400	4 000	1219	1219 K	3,21
	170	43	84 000	34 500	3 400	4 000	2219	2219 K	3,87
	200	45	129 000	51 000	3 000	3 600	1319*	1319 K*	6,84
	200	67	161 000	64 500	2 800	3 400	2319*	2319 K*	9,01
100	180	34	69 500	29 700	3 200	3 800	1220	1220 K	3,82
	180	46	94 500	38 500	3 200	3 800	2220	2220 K	4,53
	215	47	140 000	57 500	2 800	3 400	1320*	1320 K*	8,46
	215	73	187 000	79 000	2 400	3 200	2320*	2320 K*	11,6
105	190	36	75 000	32 500	3 000	3 600	1221	-	4,52
	190	50	109 000	45 000	3 000	3 600	2221	-	5,64
	225	49	154 000	64 500	2 600	3 200	1321*	-	10
	225	77	200 000	87 000	2 400	3 000	2321*	-	14,4
110	200	38	87 000	38 500	2 800	3 400	1222	1222 K	5,33
	200	53	122 000	51 500	2 800	3 400	2222*	2222 K*	6,64
	240	50	161 000	72 000	2 400	3 000	1322*	1322 K*	
	240	80	211 000	94 500	2 200	2 800	2322*	2322 K*	17,4

¹⁾ The suffix K represents bearings with tapered bores (1 : 12).

* The balls of the bearings marked * protrude slightly from the bearing face. The protrusion amounts are shown on page B73 on Cat. RB/A/GB/...

For the dimensions related to adapters, refer to Page B356 and B357 on Cat. RB/A/GB/...

Double Row Self Aligning Ball Bearings (Inch)

Bore Diameter $\frac{1}{2}$ – $2\frac{1}{4}$ Inch

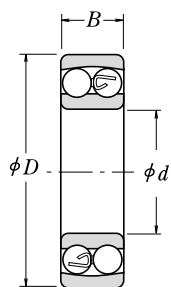

Cylindrical Bore



Boundary Dimensions (Inch)			Bearing Numbers	Basic Load Ratings (N)		Limiting Speeds (min ⁻¹)		Mass (kg)
d	D	B		C _r	C _{0r}	Grease	Oil	approx
1/2	1 1/16	3/8	NLJ 1/2	5 650	1 240	21 000	28 500	0,045
	1 1/8	5/8	NMJ 1/2	12 100	2 720	9 300	18 500	0,113
5/8	1 1/8	7/8	NLJ 5/8	8 250	2 030	18 000	24 500	0,059
	1 1/16	5/8	NMJ 5/8	12 900	3 220	16 000	22 000	0,141
3/4	1 7/8	1 1/16	NLJ 3/4	10 300	2 650	15 500	21 000	0,127
	2	1 1/8	NMJ 3/4	12 900	3 370	15 000	20 000	0,191
7/8	2	9/16	NLJ 7/8	12 900	3 370	14 400	19 500	0,145
	2 1/4	1 1/8	NMJ 7/8	18 400	4 680	13 400	18 000	0,24
1	2 1/4	5/8	NLJ 1	15 400	4 180	12 900	17 500	0,204
	2 1/2	3/4	NMJ 1	21 300	5 470	6 100	12 100	0,304
1 1/8	2 1/2	5/8	NLJ 1 1/8	16 300	4 700	11 700	16 000	0,249
	2 5/8	1 1/16	NMJ 1 1/8	25 500	7 020	5 400	10 900	0,44
1 1/4	2 3/4	1 1/16	NLJ 1 1/4	16 400	5 160	10 700	14 500	0,336
	3 1/8	7/8	NMJ 1 1/4	30 300	8 830	4 900	9 800	0,594
1 3/8	3	1 1/16	NLJ 1 3/8	19 100	5 880	4 900	9 800	0,408
	3 1/2	7/8	NMJ 1 3/8	26 100	7 940	8 900	12 000	0,771
1 1/2	3 1/4	3/4	NLJ 1 1/2	20 000	6 510	9 100	12 300	0,499
	3 3/4	5/8	NMJ 1 1/2	34 100	10 600	8 300	11 100	0,925
1 5/8	3 1/2	3/4	NLJ 1 5/8	22 700	7 400	8 400	11 400	0,594
	4	5/8	NMJ 1 5/8	32 900	10 300	3 900	7 700	1,06
1 3/4	3 3/4	1 1/16	NLJ 1 3/4	23 600	8 090	7 900	10 600	0,726
	4 1/4	1 1/8	NMJ 1 3/4	44 500	14 500	3 600	7 200	1,35
1 7/8	4	1 1/16	NLJ 1 7/8	27 800	9 990	7 200	9 800	0,835
	4 1/2	1 1/8	NMJ 1 7/8	42 800	13 100	3 300	6 700	1,47
2	4	1 1/16	NLJ 2	27 800	9 990	7 200	9 800	0,789
	4 1/2	1 1/8	NMJ 2	42 800	13 100	3 300	6 700	1,41
2 1/4	4 1/2	7/8	NLJ 2 1/4	31 500	11 500	3 200	6 400	1,09
	5	1 1/4	NMJ 2 1/4	58 500	20 100	3 000	5 900	2,04

Double Row Self Aligning Ball Bearings (Inch)

Bore Diameter 2½ – 6 Inch



Boundary Dimensions (Inch)			Bearing Numbers	Basic Load Ratings (N)		Limiting Speeds (min ⁻¹)		Mass (kg) approx
d	D	B		C _r	C _{0r}	Grease	Oil	
2½	5	5/16	NLJ2½	37 300	14 300	2 900	5 700	1,43
	5½	1¼	NMJ2½	60 500	19 600	2 700	5 400	2,51
2¾	5¼	5/16	NLJ2¾	40 600	15 700	2 700	5 400	1,54
	6¼	1⅜	NMJ2¾	74 500	26 100	2 400	4 700	3,73
3	5¾	1/16	NLJ3	43 100	16 500	2 400	4 900	2,11
	7	1/16	NMJ3	86 500	29 000	2 100	4 200	5,08
3¼	6	1/16	NLJ3¼	58 500	20 700	2 300	4 600	2,24
	7½	1/16	NMJ3¼	101 000	33 400	1 900	3 900	6,08
3⅝	7½	1/16	NMJ3⅝	101 000	33 300	1 900	3 800	5,81
3½	6½	1/8	NLJ3½	66 000	23 400	2 100	4 200	2,78
	8½	1¼	NMJ3½	133 000	46 400	3 500	4 800	7,76
3¾	6¾	1/8	NLJ3¾	64 500	23 200	2 000	4 000	3,05
	8¾	1¼	NMJ3¾	135 000	50 700	1 700	3 400	7,94
4	7¼	1/4	NLJ4	75 500	27 200	1 800	3 700	3,75
	8½	1¼	NMJ4	149 000	59 700	1 600	3 200	8,26
4¼	7½	1/4	NLJ4¼	77 500	29 500	1 700	3 500	4,05
	8¾	1¼	NMJ4¼	146 000	59 600	1 500	3 100	8,48
4½	8	1/16	NLJ4½	85 500	33 800	1 600	3 200	4,94
	9¾	2	NMJ4½	159 000	63 300	1 400	2 900	10,4
4¾	8¾	1/16	NLJ4¾	84 000	32 800	1 500	3 100	5,13
	10	2	NMJ4¾	168 000	70 100	1 300	2 700	12,7
5	9	1/8	NLJ5	88 000	33 300	1 400	2 800	6,44
	10	2	NMJ5	168 000	70 100	1 300	2 600	12,2
5½	9½	1/8	NLJ5½	109 000	43 600	1 300	2 600	7,12
	11	2	NMJ5½	191 000	88 000	1 200	2 300	15,3
6	10½	1/16	NLJ6	120 000	49 000	1 200	2 300	9,43
	12	2¼	NMJ6	211 000	100 000	1 000	2 100	20



Cylindrical Roller Bearings



Applications

- › Traction Motors (NH and NU) › Electric Motors, medium to large size › Pumps and Compressors (Centrifugal Pump, Deepwell Pump, Slurry Pump, Screw Compressor) › Plastic Forming Equipment › Blowers and Fans › Gears and Drives › Coal Pulverizers (NN)
- › Construction Equipment › Heavy Equipment › Machine Tool Spindle › Calender Rolls of Paper Making Machines › Transmissions
- › Printing Presses › Mold Oscillator Tables › Continuous Casters, Float End › Turbines › Crushers › Journal Boxes › Speed Reducers
- › Table Rollers for Steel Mills › Oil Field Equipment (Pump Jack)

Interchange

	Description	NSK	SKF	FAG	SNR
Part Number	See Interchange list				
	Polyamide cage	T	P	TVP2	G15
	Steel cage	W	J	Blank	Blank
	Machined brass cage	M	M	M, M1	M
	Extra Capacity	E	EC	E	E
	Tight Clearance	C2	C2	C2	J20
	Normal Clearance	Blank	Blank	Blank	Blank
	Loose Clearance	C3	C3	C3	J30

Series

2: light
22: light (wider than serie 2)
3: medium
23: medium (wider than serie 3)
XLRJ: Inch, extra light
LLRJ: Inch, light
MMRJ: Inch, medium

Other Features

Blank: Standard design
E: Extra capacity design

Internal Clearance

C2: Tight
Blank: Normal
C3: Loose
C4: Extra Loose

NJ

3

20

E

M

C3

Basic Type

N: Metric, no flange on outer ring
NU: Metric, no flange on inner ring
NJ: Metric, one flange on inner ring
NUP: Metric, NJ style w/locating ring
NF: Metric, one flange on outer ring
LLRJ, MMRJ: Inch, no flange on inner ring
XLRJ, LRJ, MRJ: Inch, no flanges on outer ring

Bore Size

Metric:
(04 and up: multiply last two numbers by 5 to get bore in mm)
00: 10 mm
01: 12 mm
02: 15 mm
03: 17 mm
04: 20 mm
Inch: directly indicated

Cage Material

W: Steel cage
M: Machined brass
T: Glass-fiber reinforced polyamide

NU/LLRJ, MMRJ
N/XLRJ, LRJ, MRJ
NJ
NF
NUP

Radial Internal Clearances

Nominal Bore Diameter d (mm)		Clearance in Bearings with Cylindrical Bores									
		C2		CN		C3		C4		C5	
over	include	min.	max.	min.	max.	min.	max.	min.	max.	min.	max.
-	10	0	25	20	45	35	60	50	75	-	-
10	24	0	25	20	45	35	60	50	75	65	90
24	30	0	25	20	45	35	60	50	75	70	95
30	40	5	30	25	50	45	70	60	85	80	105
40	50	5	35	30	60	50	80	70	100	95	125
50	65	10	40	40	70	60	90	80	110	110	140
65	80	10	45	40	75	65	100	90	125	130	165
80	100	15	50	50	85	75	110	105	140	155	190
100	120	15	55	50	90	85	125	125	165	180	220
120	140	15	60	60	105	100	145	145	190	200	245
140	160	20	70	70	120	115	165	165	215	225	275
160	180	25	75	75	125	120	170	170	220	250	300
180	200	35	90	90	145	140	195	195	250	275	330
200	225	45	105	105	165	160	220	220	280	305	365
225	250	45	110	110	175	170	235	235	300	330	395
250	280	55	125	125	195	190	260	260	330	370	440
280	315	55	130	130	205	200	275	275	350	410	485
215	355	65	145	145	225	225	305	305	385	455	535
355	400	100	190	190	280	280	370	370	460	510	600
400	450	110	210	210	310	310	410	410	510	565	665
450	500	110	220	220	330	330	440	440	550	625	735

Units: μm

BEARING REPLACEMENT GUIDE 171

Cylindrical Roller Bearings

Bore Diameter 20 – 35 mm

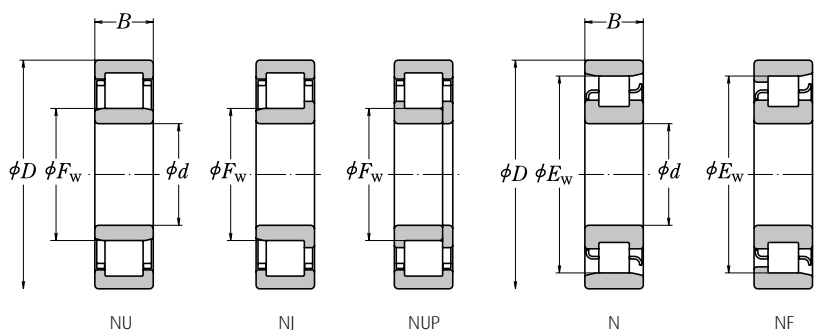

Boundary Dimensions (mm)					Basic Load Ratings (N)		Limiting Speeds ¹⁾ (min ⁻¹)		Bearing Numbers ²⁾					Mass (kg)	
d	D	B	F _w	E _w	C _r	C _{0r}	Grease	Oil	NU	NJ ³⁾	NUP	N	NF	approx	
20	47	14	-	40	15 400	12 700	15 000	18 000	N 204	-	-	N	NF	0,107	
	47	14	26,5	-	25 700	22 600	13 000	16 000	NU 204 ET	NU	NJ	NUP	-	0,107	
	47	18	27	-	20 700	18 400	13 000	16 000	NU 2204	NU	NJ	-	-	0,144	
	47	18	26,5	-	30 500	28 300	13 000	16 000	NU 2204 ET	NU	NJ	NUP	-	0,138	
	52	15	-	44,5	21 400	17 300	12 000	15 000	N 304	-	-	N	NF	0,148	
	52	15	27,5	-	31 500	26 900	12 000	15 000	NU 304 ET	NU	NJ	NUP	-	0,145	
	52	21	28,5	-	30 500	27 200	11 000	14 000	NU 2304	NU	NJ	NUP	-	0,217	
	52	21	27,5	-	42 000	39 000	11 000	14 000	NU 2304 ET	NU	NJ	NUP	-	0,209	
25	47	12	30,5	-	14 300	13 100	15 000	18 000	NU 1005	NU	-	-	-	0,094	
	52	15	-	45	17 700	15 700	13 000	16 000	N 205	-	-	N	NF	0,135	
	52	15	31,5	-	29 300	27 700	12 000	14 000	NU 205 EW	NU	NJ	NUP	-	0,136	
	52	18	31,5	-	35 000	34 500	12 000	14 000	NU 2205 ET	NU	NJ	NUP	-	0,16	
	62	17	-	53	29 300	25 200	10 000	13 000	N 305	-	-	N	NF	0,233	
	62	17	34	-	41 500	37 500	10 000	12 000	NU 305 EW	NU	NJ	NUP	-	0,269	
	62	24	34	-	57 000	56 000	9 000	11 000	NU 2305 ET	NU	NJ	NUP	-	0,338	
	80	21	38,8	62,8	46 500	40 000	9 000	11 000	NU 405	NU	NJ	-	N	NF	0,57
30	55	13	36,5	48,5	19 700	19 600	12 000	15 000	NU 1006	NU	-	N	-	0,136	
	62	16	-	53,5	24 900	23 300	11 000	13 000	N 206	-	-	N	NF	0,208	
	62	16	37,5	-	39 000	37 500	9 500	12 000	NU 206 EW	NU	NJ	NUP	-	0,205	
	62	20	37,5	-	49 000	50 000	9 500	12 000	NU 2206 ET	NU	NJ	NUP	-	0,255	
	72	19	-	62	38 500	35 000	8 500	11 000	N 306	-	-	N	NF	0,353	
	72	19	40,5	-	53 000	50 000	8 500	10 000	NU 306 EW	NU	NJ	NUP	-	0,409	
	72	27	40,5	-	74 500	77 500	8 000	9 500	NU 2306 ET	NU	NJ	NUP	-	0,518	
	90	23	45	73	62 500	55 000	7 500	9 500	NU 406	NU	NJ	-	N	NF	0,758
35	62	14	42	55	22 600	23 200	11 000	13 000	NU 1007	NU	NJ	-	N	-	0,18
	72	17	-	61,8	35 500	34 000	9 500	11 000	N 207	-	-	N	NF	0,301	
	72	17	44	-	50 500	50 000	8 500	10 000	NU 207 EW	NU	NJ	NUP	-	0,304	
	72	23	44	-	61 500	65 000	8 500	10 000	NU 2207 ET	NU	NJ	NUP	-	0,40	
	80	21	-	68,2	49 500	47 000	8 000	9 500	N 307	-	-	N	NF	0,476	
	80	21	46,2	-	66 500	65 500	7 500	9 500	NU 307 EW	NU	NJ	NUP	-	0,545	
	80	31	46,2	-	93 000	101 000	6 700	8 500	NU 2307 ET	NU	NJ	NUP	-	0,711	
	100	25	53	83	75 500	69 000	6 700	8 000	NU 407	NU	NJ	-	N	NF	1,01

¹⁾ The limiting speeds listed above apply to bearings with machined cages (No suffix). For bearings with pressed cages, reduce the limiting speed by 20%. (Not applicable to bearing numbers with an EM, EW, or ET suffix.)

²⁾ The bearings with suffix ET have polyamide cage. The maximum operating temperature should be less than 120°C.

³⁾ When L-shaped thrust collars (See section for L-Shaped Thrust Collars starting on page B100 in Cat. RB/A/GB/...) are used, the bearings become the NH type.

Cylindrical Roller Bearings

Bore Diameter 40 – 55 mm

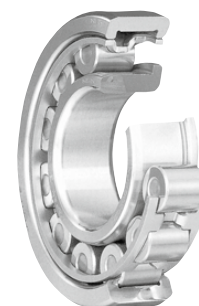

Boundary Dimensions (mm)					Basic Load Ratings (N)		Limiting Speeds ¹⁾ (min ⁻¹)		Bearing Numbers ²⁾					Mass (kg)	
d	D	B	F _w	E _w	C _r	C _{0r}	Grease	Oil	NU	NJ ³⁾	NUP	N	NF	approx	
40	68	15	47	61	27 300	29 000	10 000	12 000	NU 1008	NU	NJ	NUP	N	-	0,223
	80	18	-	70	43 500	43 000	8 500	10 000	N 208	-	-	-	N	NF	0,375
	80	18	49,5	-	55 500	55 500	7 500	9 000	NU 208 EW	NU	NJ	NUP	-	-	0,379
	80	23	49,5	-	72 500	77 500	7 500	9 000	NU 2208 ET	NU	NJ	NUP	-	-	0,480
	90	23	-	77,5	58 500	57 000	6 700	8 500	N 308	-	-	-	N	NF	0,649
	90	23	52	-	83 000	81 500	6 700	8 000	NU 308 EW	NU	NJ	NUP	-	-	0,747
	90	33	52	-	114 000	122 000	6 000	7 500	NU 2308 ET	NU	NJ	NUP	-	-	0,933
110	27	58	92	95 500	89 000	6 000	7 500	NU 408	NU	NJ	NUP	N	NF	1,28	
45	75	16	52,5	67,5	32 500	35 500	9 000	11 000	NU 1009	NU	-	-	N	NF	0,279
	85	19	-	75	46 000	47 000	7 500	9 000	N 209	-	-	-	N	NF	0,429
	85	19	54,5	-	63 000	66 500	6 700	8 000	NU 209 EW	NU	NJ	NUP	-	-	0,438
	85	23	54,5	-	76 000	84 500	6 700	8 500	NU 2209 ET	NU	NJ	NUP	-	-	0,521
	100	25	-	86,5	74 000	71 000	6 300	7 500	N 309	-	-	-	N	NF	0,869
	100	25	58,5	-	97 500	98 500	6 000	7 500	NU 309 EW	NU	NJ	NUP	-	-	1,01
	100	36	58,5	-	137 000	153 000	5 300	6 700	NU 2309 ET	NU	NJ	NUP	-	-	1,28
120	29	64,5	100,5	107 000	102 000	5 600	6 700	NU 409	NU	NJ	NUP	N	NF	1,62	
50	80	16	57,5	72,5	32 000	36 000	8 000	10 000	NU 1010	NU	NJ	NUP	N	-	0,301
	90	20	-	80,4	48 000	51 000	7 100	8 500	N 210	-	-	-	N	NF	0,483
	90	20	59,5	-	69 000	76 500	6 300	7 500	NU 210 EW	NU	NJ	NUP	-	-	0,50
	90	23	59,5	-	83 500	97 000	6 300	8 000	NU 2210 ET	NU	NJ	NUP	-	-	0,562
	110	27	-	95	87 000	86 000	5 600	6 700	N 310	-	-	-	N	NF	1,11
	110	27	65	-	110 000	113 000	5 000	6 000	NU 310 EW	NU	NJ	NUP	-	-	1,3
	110	40	65	-	163 000	187 000	5 000	6 300	NU 2310 ET	NU	NJ	NUP	-	-	1,7
130	31	70,8	110,8	129 000	124 000	5 000	6 000	NU 410	NU	NJ	NUP	N	NF	1,99	
55	90	18	64,5	80,5	37 500	44 000	7 500	9 000	NU 1011	NU	NJ	-	N	-	0,445
	100	21	-	88,5	58 000	62 500	6 300	7 500	N 211	-	-	-	N	NF	0,634
	100	21	66	-	86 500	98 500	5 600	7 100	NU 211 EW	NU	NJ	NUP	-	-	0,669
	100	25	66	-	101 000	122 000	5 600	7 100	NU 2211 ET	NU	NJ	NUP	-	-	0,783
	120	29	-	104,5	111 000	111 000	5 000	6 300	N 311	-	-	-	N	NF	1,42
	120	29	70,5	-	137 000	143 000	4 500	5 600	NU 311 EW	NU	NJ	NUP	-	-	1,64
	120	43	70,5	-	201 000	233 000	4 500	5 600	NU 2311 ET	NU	NJ	NUP	-	-	2,18
	140	33	77,2	117,2	139 000	138 000	4 500	5 600	NU 411	NU	NJ	NUP	N	NF	2,5

¹⁾ The limiting speeds listed above apply to bearings with machined cages (No suffix). For bearings with pressed cages, reduce the limiting speed by 20%. (Not applicable to bearing numbers with an EM, EW, or ET suffix.)

²⁾ The bearings with suffix ET have polyamide cage. The maximum operating temperature should be less than 120°C.

³⁾ When L-shaped thrust collars (See section for L-Shaped Thrust Collars starting on page B100 in Cat. RB/A/GB/...) are used, the bearings become the NH type.

Cylindrical Roller Bearings

Bore Diameter 60 – 75 mm

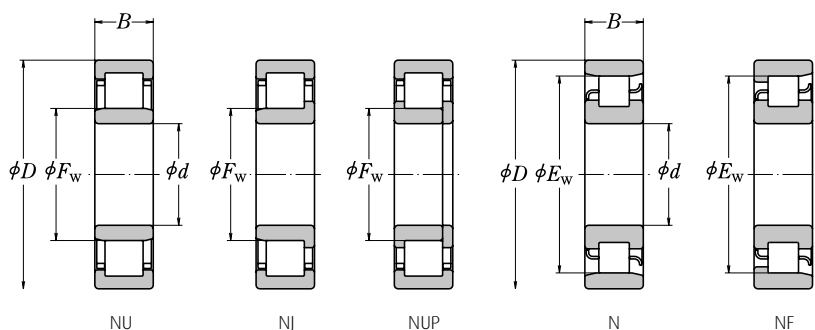

Boundary Dimensions (mm)					Basic Load Ratings (N)		Limiting Speeds ¹⁾ (min ⁻¹)		Bearing Numbers ²⁾					Mass (kg)	
d	D	B	F _w	E _w	C _r	C _{0r}	Grease	Oil	NU	NJ ³⁾	NUP	N	NF	approx	
60	95	18	69,5	85,5	40 000	48 500	6 700	8 500	NU 1012	NU	NJ	-	N	NF	0,474
	110	22	-	97,5	68 500	75 000	6 000	7 100	N 212	-	-	-	N	NF	0,823
	110	22	72	-	97 500	107 000	5 300	6 300	NU 212 EW	NU	NJ	NUP	-	-	0,824
	110	28	72	-	131 000	157 000	5 300	6 300	NU 2212 ET	NU	NJ	NUP	-	-	1,06
	130	31	-	113	124 000	126 000	4 800	5 600	N 312	-	-	-	N	NF	1,78
	130	31	77	-	124 000	126 000	4 800	5 600	NU 312	NU	NJ	NUP	-	-	1,82
	130	31	77	-	150 000	157 000	4 800	5 600	NU 312 EM	NU	NJ	NUP	-	-	2,06
	130	46	77	-	222 000	262 000	4 300	5 300	NU 2312 ET	NU	NJ	NUP	-	-	2,7
	150	35	83	127	167 000	168 000	4 300	5 300	NU 412	NU	NJ	NUP	N	NF	3,04
65	100	18	74,5	90,5	41 000	51 000	6 300	8 000	NU 1013	NU	NJ	-	N	NF	0,504
	120	23	-	105,6	84 000	94 500	5 300	6 300	N 213	-	-	-	N	NF	1,05
	120	23	78,5	-	108 000	119 000	4 800	5 600	NU 213 EW	NU	NJ	NUP	-	-	1,05
	120	31	78,5	-	149 000	181 000	4 800	6 000	NU 2213 ET	NU	NJ	NUP	-	-	1,41
	140	33	-	121,5	135 000	139 000	4 300	5 300	N 313	-	-	-	N	NF	2,17
	140	33	83,5	-	135 000	139 000	4 300	5 300	NU 313	NU	NJ	NUP	-	-	2,23
	140	33	82,5	-	181 000	191 000	4 300	5 300	NU 313 EM	NU	NJ	NUP	-	-	2,56
	140	48	82,5	-	233 000	265 000	3 800	4 800	NU 2313 ET	NU	NJ	NUP	-	-	3,16
	160	37	89,3	135,3	182 000	186 000	4 000	4 800	NU 413	NU	NJ	-	N	NF	3,63
70	110	20	80	100	58 500	70 500	6 000	7 100	NU 1014	NU	NJ	NUP	N	NF	0,693
	125	24	-	110,5	83 500	95 000	5 000	6 300	N 214	-	-	-	N	NF	1,14
	125	24	83,5	-	119 000	137 000	5 000	6 300	NU 214 EM	NU	NJ	NUP	-	-	1,29
	125	31	83,5	-	156 000	194 000	4 500	5 600	NU 2214 ET	NU	NJ	NUP	-	-	1,49
	150	35	-	130	158 000	168 000	4 000	5 000	N 314	-	-	-	N	NF	2,67
	150	35	90	-	158 000	168 000	4 000	5 000	NU 314	NU	NJ	NUP	-	-	2,75
	150	35	89	-	205 000	222 000	4 000	5 000	NU 314 EM	NU	NJ	NUP	-	-	3,09
	150	51	89	-	274 000	325 000	3 600	4 500	NU 2314 ET	NU	NJ	NUP	-	-	3,92
	180	42	100	152	228 000	236 000	3 600	4 300	NU 414	NU	NJ	NUP	N	NF	5,28
75	115	20	85	105	60 000	74 500	5 600	6 700	NU 1015	NU	-	-	N	NF	0,731
	130	25	-	116,5	96 500	111 000	4 800	6 000	N 215	-	-	-	N	NF	1,23
	130	25	88,5	-	130 000	156 000	4 800	6 000	NU 215 EM	NU	NJ	NUP	-	-	1,44
	130	31	88,5	-	162 000	207 000	4 300	5 300	NU 2215 ET	NU	NJ	NUP	-	-	1,57
	160	37	-	139,5	179 000	189 000	3 800	4 800	N 315	-	-	-	N	NF	3,2
	160	37	95,5	-	179 000	189 000	3 800	4 800	NU 315	NU	NJ	NUP	-	-	3,26
	160	37	95	-	240 000	263 000	3 800	4 800	NU 315 EM	NU	NJ	NUP	-	-	3,73
	160	55	95	-	330 000	395 000	3 400	4 300	NU 2315 ET	NU	NJ	NUP	-	-	4,86
	190	45	104,5	160,5	262 000	274 000	3 400	4 000	NU 415	NU	NJ	-	N	NF	6,27

¹⁾ The limiting speeds listed above apply to bearings with machined cages (No suffix). For bearings with pressed cages, reduce the limiting speed by 20%. (Not applicable to bearing numbers with an EM, EW, or ET suffix.)

²⁾ The bearings with suffix ET have polyamide cage. The maximum operating temperature should be less than 120°C.

³⁾ When L-shaped thrust collars (See section for L-Shaped Thrust Collars starting on page B100 in Cat. RB/A/GB/...) are used, the bearings become the NH type.

Cylindrical Roller Bearings

Bore Diameter 80 – 95 mm

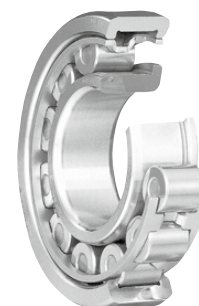

Boundary Dimensions (mm)					Basic Load Ratings (N)		Limiting Speeds ¹⁾ (min ⁻¹)		Bearing Numbers ²⁾					Mass (kg)	
d	D	B	F _w	E _w	C _r	C _{0r}	Grease	Oil	NU	NJ ³⁾	NUP	N	NF	approx	
80	125	22	91,5	113,5	72 500	90 500	5 300	6 300	NU 1016	NU	-	NUP	N	-	0,969
	140	26	-	125,3	106 000	122 000	4 500	5 300	N 216	-	-	-	N	NF	1,47
	140	26	95,3	-	139 000	167 000	4 500	5 300	NU 216 EM	NU	NJ	NUP	-	-	1,7
	140	33	95,3	-	186 000	243 000	4 000	5 000	NU 2216 ET	NU	NJ	NUP	-	-	1,96
	170	39	-	147	190 000	207 000	3 600	4 300	N 316	-	-	-	N	NF	3,85
	170	39	101	-	256 000	282 000	3 600	4 300	NU 316 EM	NU	NJ	NUP	-	-	4,45
	170	58	101	-	355 000	430 000	3 200	4 000	NU 2316 ET	NU	NJ	NUP	-	-	5,73
	200	48	110	170	299 000	315 000	3 200	3 800	NU 416	NU	NJ	-	N	NF	7,3
85	130	22	96,5	118,5	74 500	95 500	5 000	6 000	NU 1017	NU	-	-	N	-	1,01
	150	28	-	133,8	120 000	140 000	4 300	5 000	N 217	-	-	-	N	NF	1,87
	150	28	100,5	-	167 000	199 000	4 300	5 000	NU 217 EM	NU	NJ	NUP	-	-	2,11
	150	36	100,5	-	217 000	279 000	3 800	4 500	NU 2217 ET	NU	NJ	NUP	-	-	2,44
	180	41	-	156	212 000	228 000	3 400	4 000	N 317	-	-	-	N	NF	4,53
	180	41	108	-	212 000	228 000	3 400	4 000	NU 317	NU	NJ	NUP	-	-	4,6
	180	41	108	-	291 000	330 000	3 400	4 000	NU 317 EM	NU	NJ	NUP	-	-	5,26
	180	60	108	-	395 000	485 000	3 000	3 800	NU 2317 ET	NU	NJ	NUP	-	-	6,77
	210	52	113	177	335 000	350 000	3 000	3 800	NU 417	NU	NJ	-	N	NF	9,56
90	140	24	103	127	88 000	114 000	4 500	5 600	NU 1018	NU	-	NUP	N	-	1,35
	160	30	-	143	152 000	178 000	4 000	4 800	N 218	-	-	-	N	NF	2,31
	160	30	107	-	182 000	217 000	4 000	4 800	NU 218 EM	NU	NJ	NUP	-	-	2,6
	160	40	107	-	242 000	315 000	3 600	4 300	NU 2218 ET	NU	NJ	NUP	-	-	3,11
	190	43	-	165	240 000	265 000	3 200	3 800	N 318	-	-	-	N	NF	5,31
	190	43	113,5	-	240 000	265 000	3 200	3 800	NU 318	NU	NJ	NUP	-	-	5,38
	190	43	113,5	-	315 000	355 000	3 200	3 800	NU 318 EM	NU	NJ	NUP	-	-	6,1
	190	64	113,5	-	435 000	535 000	2 800	3 400	NU 2318 ET	NU	NJ	NUP	-	-	7,9
	225	54	123,5	191,5	375 000	400 000	2 800	3 400	NU 418	NU	NJ	-	N	NF	11,5
95	145	24	108	132	90 500	120 000	4 300	5 300	NU 1019	NU	NJ	-	N	-	1,41
	170	32	-	151,5	158 000	183 000	3 800	4 500	N 219	-	-	-	N	NF	2,79
	170	32	112,5	-	220 000	265 000	3 800	4 500	NU 219 EM	NU	NJ	NUP	-	-	3,17
	170	43	112,5	-	273 000	350 000	3 400	4 000	NU 2219 ET	NU	NJ	NUP	-	-	3,81
	200	45	-	173,5	259 000	289 000	3 000	3 600	N 319	-	-	-	N	NF	6,09
	200	45	121,5	-	259 000	289 000	3 000	3 600	NU 319	NU	NJ	NUP	-	-	6,23
	200	45	121,5	-	335 000	385 000	3 000	3 600	NU 319 EM	NU	NJ	NUP	-	-	7,13
	200	67	121,5	-	460 000	585 000	2 600	3 400	NU 2319 ET	NU	NJ	NUP	-	-	9,21
	240	55	133,5	201,5	400 000	445 000	2 600	3 200	NU 419	NU	NJ	NUP	-	NF	13,6

¹⁾ The limiting speeds listed above apply to bearings with machined cages (No suffix). For bearings with pressed cages, reduce the limiting speed by 20%. (Not applicable to bearing numbers with an EM, EW, or ET suffix.)

²⁾ The bearings with suffix ET have polyamide cage. The maximum operating temperature should be less than 120°C.

³⁾ When L-shaped thrust collars (See section for L-Shaped Thrust Collars starting on page B100 in Cat. RB/A/GB/...) are used, the bearings become the NH type.

Cylindrical Roller Bearings

Bore Diameter 100 – 120 mm

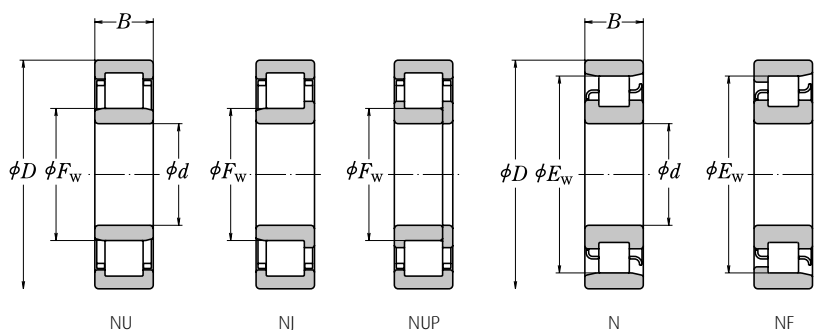

Boundary Dimensions (mm)					Basic Load Ratings (N)		Limiting Speeds ¹⁾ (min ⁻¹)		Bearing Numbers ²⁾					Mass (kg)	
d	D	B	F _w	E _w	C _r	C _{0r}	Grease	Oil	NU	NJ ³⁾	NUP	N	NF	approx	
100	150	24	113	137	93 000	126 000	4 300	5 300	NU 1020	NU	NJ	NUP	N	-	1,47
	180	34	-	160	183 000	217 000	3 600	4 300	N 220	-	-	-	N	NF	3,36
	180	34	119	-	249 000	305 000	3 600	4 300	NU 220 EM	NU	NJ	NUP	-	-	3,81
	180	46	119	-	335 000	445 000	3 200	3 800	NU 2220 ET	NU	NJ	NUP	-	-	4,69
	215	47	-	185,5	299 000	335 000	2 800	3 400	N 320	-	-	-	N	NF	7,59
	215	47	129,5	-	299 000	335 000	2 800	3 400	NU 320	NU	NJ	NUP	-	-	7,69
	215	47	127,5	-	380 000	425 000	2 800	3 400	NU 320 EM	NU	NJ	NUP	-	-	8,63
	215	73	127,5	-	570 000	715 000	2 400	3 000	NU 2320 ET	NU	NJ	NUP	-	-	11,8
	250	58	139	211	450 000	500 000	2 600	3 000	NU 420	NU	NJ	-	N	NF	15,5
105	160	26	119,5	145,5	109 000	149 000	4 000	4 800	NU 1021	NU	-	-	N	NF	1,83
	190	36	-	168,8	201 000	241 000	3 400	4 000	N 221	-	-	-	N	NF	4,0
	190	36	125	-	262 000	310 000	3 400	4 000	NU 221 EM	NU	NJ	NUP	-	-	4,58
	225	49	-	195	320 000	360 000	2 600	3 200	N 321	-	-	-	N	NF	8,69
	225	49	133	-	425 000	480 000	2 600	3 200	NU 321 EM	NU	NJ	NUP	-	-	9,84
	260	60	144,5	220,5	495 000	555 000	2 400	3 000	NU 421	NU	NJ	-	N	NF	17,3
110	170	28	125	155	131 000	174 000	3 800	4 500	NU 1022	NU	NJ	-	N	NF	2,27
	200	38	-	178,5	229 000	272 000	3 200	3 800	N 222	-	-	-	N	NF	4,64
	200	38	132,5	-	293 000	365 000	3 200	3 800	NU 222 EM	NU	NJ	NUP	-	-	5,37
	200	53	132,5	-	385 000	515 000	2 800	3 400	NU 2222 EM	NU	NJ	NUP	-	-	7,65
	240	50	-	207	360 000	400 000	2 600	3 000	N 322	-	-	-	N	NF	10,3
	240	50	143	-	450 000	525 000	2 600	3 000	NU 322 EM	NU	NJ	NUP	-	-	11,8
	280	65	155	-	550 000	620 000	2 200	2 800	NU 422	NU	NJ	-	-	-	22,1
120	180	28	135	165	139 000	191 000	3 400	4 300	NU 1024	NU	NJ	NUP	N	-	2,43
	215	40	-	191,5	248 000	299 000	3 000	3 400	N 224	-	-	-	N	NF	5,63
	215	40	143,5	-	335 000	420 000	3 000	3 400	NU 224 EM	NU	NJ	NUP	-	-	6,43
	215	58	143,5	-	450 000	620 000	2 600	3 200	NU 2224 EM	NU	NJ	NUP	-	-	9,51
	260	55	-	226	450 000	510 000	2 200	2 800	N 324	-	-	-	N	NF	12,9
	260	55	154	-	530 000	610 000	2 200	2 800	NU 324 EM	NU	NJ	NUP	-	-	15
	260	86	154	-	795 000	1 030 000	2 000	2 600	NU 2324 EM	NU	NJ	NUP	-	-	25
	310	72	170	260	675 000	770 000	2 000	2 400	NU 424	NU	NJ	NUP	N	-	30,2

¹⁾ The limiting speeds listed above apply to bearings with machined cages (No suffix). For bearings with pressed cages, reduce the limiting speed by 20%. (Not applicable to bearing numbers with an EM, EW, or ET suffix.)

²⁾ The bearings with suffix ET have polyamide cage. The maximum operating temperature should be less than 120°C.

³⁾ When L-shaped thrust collars (See section for L-Shaped Thrust Collars starting on page B100 in Cat. RB/A/GB/...) are used, the bearings become the NH type.

Cylindrical Roller Bearings

Bore Diameter 130 – 160 mm



Boundary Dimensions (mm)					Basic Load Ratings (N)		Limiting Speeds ¹⁾ (min ⁻¹)		Bearing Numbers ²⁾					Mass (kg)	
d	D	B	F _w	E _w	C _r	C _{0r}	Grease	Oil	NU	NJ ³⁾	NUP	N	NF	approx	
130	200	33	148	182	172 000	238 000	3 200	3 800	NU 1026	NU	NJ	-	N	NF	3,66
	230	40	-	204	258 000	320 000	2 600	3 200	N 226	-	-	-	N	NF	6,48
	230	40	153,5	-	365 000	455 000	2 600	3 200	NU 226 EM	NU	NJ	NUP	-	-	8,03
	230	64	153,5	-	530 000	735 000	2 400	3 000	NU 2226 EM	NU	NJ	NUP	-	-	9,44
	280	58	-	243	500 000	570 000	2 200	2 600	N 326	-	-	-	N	NF	17,7
	280	58	167	-	615 000	735 000	2 200	2 600	NU 326 EM	NU	NJ	NUP	-	-	18,7
	280	93	167	-	920 000	1 230 000	1 900	2 400	NU 2326 EM	NU	NJ	NUP	-	-	30
	340	78	185	285	825 000	955 000	1 800	2 200	NU 426	NU	NJ	-	-	NF	39,6
140	210	33	158	192	176 000	250 000	3 000	3 600	NU 1028	NU	NJ	NUP	N	-	3,87
	250	42	-	221	297 000	375 000	2 400	3 000	N 228	-	-	-	N	NF	8,08
	250	42	169	-	395 000	515 000	2 400	3 000	NU 228 EM	NU	NJ	NUP	-	-	9,38
	250	68	169	-	550 000	790 000	2 200	2 800	NU 2228 EM	NU	NJ	NUP	-	-	15,2
	300	62	-	260	550 000	640 000	2 000	2 400	N 328	-	-	-	N	NF	21,7
	300	62	180	-	665 000	795 000	2 000	2 400	NU 328 EM	NU	NJ	NUP	-	-	22,8
	300	102	180	-	1 020 000	1 380 000	1 700	2 200	NU 2328 EM	NU	NJ	NUP	-	-	37,7
	360	82	198	302	875 000	1 020 000	1 700	2 000	NU 428	NU	NJ	-	N	-	46,4
150	225	35	169,5	205,5	202 000	294 000	2 800	3 400	NU 1030	NU	NJ	-	N	NF	4,77
	270	45	-	238	345 000	435 000	2 200	2 800	N 230	-	-	-	N	NF	10,4
	270	45	182	-	450 000	595 000	2 200	2 800	NU 230 EM	NU	NJ	NUP	-	-	11,9
	270	73	182	-	635 000	930 000	2 000	2 600	NU 2230 EM	NU	NJ	NUP	-	-	19,3
	320	65	-	277	590 000	690 000	1 800	2 200	N 330	-	-	-	N	NF	25,8
	320	65	193	-	760 000	920 000	1 800	2 200	NU 330 EM	005/12/2	NJ	NUP	-	-	27,1
	320	108	193	-	1 160 000	1 600 000	1 600	2 000	NU 2330 EM	NU	NJ	NUP	-	-	45,1
	380	85	213	-	930 000	1 120 000	1 600	2 000	NU 430	NU	NJ	-	-	-	55,8
160	240	38	180	220	238 000	340 000	2 600	3 200	NU 1032	NU	NJ	-	N	NF	5,81
	290	48	-	255	430 000	570 000	2 200	2 600	N 232	-	-	-	N	NF	14,1
	290	48	195	-	500 000	665 000	2 200	2 600	NU 232 EM	NU	NJ	NUP	-	-	14,7
	290	80	193	-	810 000	1 190 000	1 900	2 400	NU 2232 EM	NU	NJ	NUP	-	-	24,5
	340	68	-	292	700 000	875 000	1 700	2 000	N 332	-	-	-	N	-	30,8
	340	68	204	-	860 000	1 050 000	1 700	2 000	NU 332 EM	NU	NJ	NUP	-	-	32,1
	340	114	204	-	1 310 000	1 820 000	1 500	1 900	NU 2332 EM	NU	NJ	NUP	-	-	53,9

¹⁾ The limiting speeds listed above apply to bearings with machined cages (No suffix). For bearings with pressed cages, reduce the limiting speed by 20%. (Not applicable to bearing numbers with an EM, EW, or ET suffix.)

²⁾ The bearings with suffix ET have polyamide cage. The maximum operating temperature should be less than 120°C.

³⁾ When L-shaped thrust collars (See section for L-Shaped Thrust Collars starting on page B100 in Cat. RB/A/GB/...) are used, the bearings become the NH type.

Cylindrical Roller Bearings

Bore Diameter 170 – 220 mm

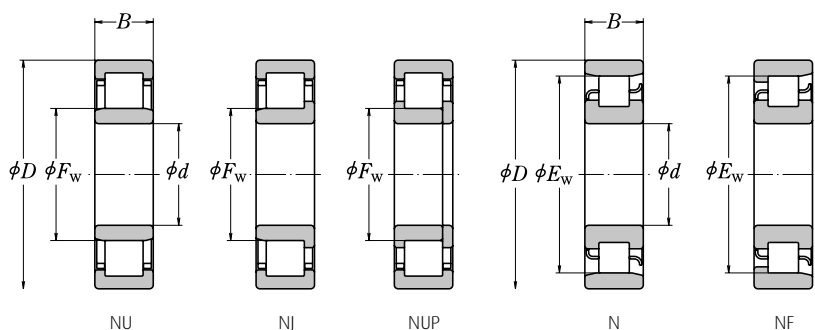

Boundary Dimensions (mm)					Basic Load Ratings (N)		Limiting Speeds ¹⁾ (min ⁻¹)		Bearing Numbers ²⁾					Mass (kg)	
d	D	B	F _w	E _w	C _r	C _{0r}	Grease	Oil	NU	NJ ³⁾	NUP	N	NF	approx	
170	260	42	193	237	287 000	415 000	2 400	2 800	NU 1034	NU	NJ	-	N	-	7,91
	310	52	-	272	475 000	635 000	2 000	2 400	N 234	-	-	-	N	NF	17,4
	310	52	207	-	605 000	800 000	2 000	2 400	NU 234 EM	NU	NJ	NUP	-	-	18,3
	310	86	205	-	925 000	1 330 000	1 800	2 200	NU 2234 EM	NU	NJ	NUP	-	-	29,9
	360	72	-	310	795 000	1 010 000	1 600	2 000	N 334	-	-	-	N	-	36,6
	360	72	218	-	930 000	1 150 000	1 600	2 000	NU 334 EM	NU	NJ	NUP	-	-	37,9
	360	120	216	-	1 490 000	2 070 000	1 400	1 800	NU 2334 EM	NU	NJ	NUP	-	-	63,4
180	280	46	205	255	355 000	510 000	2 200	2 600	NU 1036	NU	NJ	-	N	NF	10,2
	320	52	-	282	495 000	675 000	1 900	2 200	N 236	-	-	-	N	NF	18,1
	320	52	217	-	625 000	850 000	1 900	2 200	NU 236 EM	NU	NJ	NUP	-	-	19
	320	86	215	-	1 010 000	1 510 000	1 700	2 000	NU 2236 EM	NU	NJ	NUP	-	-	31,4
	380	75	-	328	905 000	1 150 000	1 500	1 800	N 336	-	-	-	N	NF	42,6
	380	75	231	-	985 000	1 230 000	1 500	1 800	NU 336 EM	NU	NJ	NUP	-	-	44
	380	126	227	-	1 560 000	2 220 000	1 300	1 700	NU 2336 EM	NU	NJ	NUP	-	-	74,6
190	290	46	215	265	365 000	535 000	2 000	2 600	NU 1038	NU	NJ	-	N	-	10,7
	340	55	-	299	555 000	770 000	1 800	2 200	N 238	-	-	-	N	NF	22
	340	55	230	-	695 000	955 000	1 800	2 200	NU 238 EM	NU	NJ	NUP	-	-	23
	340	92	228	-	1 100 000	1 670 000	1 600	2 000	NU 2238 EM	NU	NJ	NUP	-	-	38,3
	400	78	-	345	975 000	1 260 000	1 400	1 700	N 338	-	-	-	N	-	48,7
	400	78	245	-	1 060 000	1 340 000	1 400	1 700	NU 338 EM	NU	NJ	NUP	-	-	50,6
	400	132	240	-	1 770 000	2 520 000	1 300	1 600	NU 2338 EM	NU	NJ	NUP	-	-	86,2
200	310	51	229	281	390 000	580 000	2 000	2 400	NU 1040	NU	NJ	-	N	NF	14
	360	58	-	316	620 000	865 000	1 700	2 000	N 240	-	-	-	N	NF	26,2
	360	58	243	-	765 000	1 060 000	1 700	2 000	NU 240 EM	NU	NJ	NUP	-	-	27,4
	360	98	241	-	1 220 000	1 870 000	1 500	1 800	NU 2240 EM	NU	NJ	NUP	-	-	46,1
	420	80	-	360	975 000	1 270 000	1 300	1 600	N 340	-	-	-	N	NF	55,3
	420	80	258	-	1 140 000	1 450 000	1 300	1 600	NU 340 EM	NU	NJ	NUP	-	-	57,1
	420	138	253	-	1 910 000	2 760 000	1 200	1 500	NU 2340 EM	NU	NJ	NUP	-	-	99,3
220	340	56	250	310	500 000	750 000	1 800	2 200	NU 1044	NU	NJ	-	N	-	18,2
	400	65	-	350	760 000	1 080 000	1 500	1 800	N 244	-	-	-	N	NF	37
	400	65	270	-	760 000	1 080 000	1 500	1 800	NU 244	NU	NJ	NUP	-	-	37,3
	400	108	270	-	1 140 000	1 810 000	1 300	1 600	NU 2244	NU	-	-	-	-	61,8
	460	88	-	396	1 190 000	1 570 000	1 200	1 500	N 344	-	-	-	N	-	72,8
	460	88	284	-	1 190 000	1 570 000	1 200	1 500	NU 344	NU	NJ	-	-	-	74,6

¹⁾ The limiting speeds listed above apply to bearings with machined cages (No suffix). For bearings with pressed cages, reduce the limiting speed by 20%. (Not applicable to bearing numbers with an EM, EW, or ET suffix.)

²⁾ The bearings with suffix ET have polyamide cage. The maximum operating temperature should be less than 120°C.

³⁾ When L-shaped thrust collars (See section for L-Shaped Thrust Collars starting on page B100 in Cat. RB/A/GB/...) are used, the bearings become the NH type.

Cylindrical Roller Bearings

Bore Diameter 240 – 500 mm



Boundary Dimensions (mm)					Basic Load Ratings (N)		Limiting Speeds ¹⁾ (min ⁻¹)		Bearing Numbers ²⁾					Mass (kg)	
d	D	B	F _w	E _w	C _r	C _{0r}	Grease	Oil	NU	NJ ³⁾	NUP	N	NF	approx	
240	360	56	270	330	530 000	820 000	1 600	2 000	NU 1048	NU	NJ	-	N	-	19,5
	440	72	-	385	935 000	1 340 000	1 300	1 600	N 248	-	-	-	N	NF	49,6
	440	72	295	-	935 000	1 340 000	1 300	1 600	NU 248	NU	NJ	NUP	-	-	50,4
	440	120	295	-	1 440 000	2 320 000	1 200	1 500	NU 2248	NU	-	-	-	-	84,9
	500	95	-	430	1 360 000	1 820 000	1 100	1 300	N 348	-	-	-	N	-	92,3
	500	95	310	-	1 360 000	1 820 000	1 100	1 300	NU 348	NU	NJ	-	-	-	94,6
260	400	65	296	364	645 000	1 000 000	1 500	1 800	NU 1052	NU	NJ	-	N	NF	29,1
	480	80	-	420	1 100 000	1 580 000	1 200	1 500	N 252	-	-	-	N	-	66,2
	480	80	320	-	1 100 000	1 580 000	1 200	1 500	NU 252	NU	NJ	-	-	-	67,1
	480	130	320	-	1 710 000	2 770 000	1 100	1 300	NU 2252	NU	-	NUP	-	-	111
	540	102	336	-	1 540 000	2 090 000	1 000	1 200	NU 352	NU	NJ	-	-	-	118
	280	420	65	316	384	660 000	1 050 000	1 400	1 700	NU 1056	NU	NJ	NUP	N	NF
500		80	-	440	1 140 000	1 680 000	1 100	1 400	N 256	-	-	-	N	NF	69,6
500		80	340	-	1 140 000	1 680 000	1 100	1 400	NU 256	NU	NJ	-	-	-	70,7
300	460	74	340	420	885 000	1 400 000	1 300	1 500	NU 1060	NU	NJ	-	N	NF	43,7
	540	85	364	-	1 400 000	2 070 000	1 100	1 300	NU 260	NU	NJ	-	-	-	89,2
320	480	74	360	440	905 000	1 470 000	1 200	1 400	NU 1064	NU	-	-	N	NF	46,1
	580	92	-	510	1 540 000	2 270 000	950	1 200	N 264	-	-	-	N	-	110
	580	92	390	-	1 540 000	2 270 000	950	1 200	NU 264	NU	NJ	-	-	-	112
340	520	82	385	475	1 080 000	1 740 000	1 100	1 300	NU 1068	NU	NJ	-	N	NF	61,8
360	540	82	405	495	1 110 000	1 830 000	1 000	1 300	NU 1072	NU	-	-	N	NF	64,6
380	560	82	425	-	1 140 000	1 910 000	1 000	1 200	NU 1076	NU	-	-	-	-	67,5
400	600	90	450	550	1 360 000	2 280 000	900	1 100	NU 1080	NU	-	NUP	N	-	88,2
420	620	90	470	570	1 390 000	2 380 000	850	1 100	NU 1084	NU	-	-	N	-	91,7
440	650	94	493	-	1 470 000	2 530 000	800	1 000	NU 1088	NU	-	-	-	-	105
460	680	100	516	624	1 580 000	2 740 000	750	950	NU 1092	NU	-	NUP	N	-	123
480	700	100	536	644	1 620 000	2 860 000	750	900	NU 1096	NU	NJ	-	N	-	127
500	720	100	556	664	1 660 000	2 970 000	710	850	NU 10/500	10/500	-	-	N	-	131

¹⁾ The limiting speeds listed above apply to bearings with machined cages (No suffix). For bearings with pressed cages, reduce the limiting speed by 20%. (Not applicable to bearing numbers with an EM, EW, or ET suffix.)

²⁾ The bearings with suffix ET have polyamide cage. The maximum operating temperature should be less than 120°C.

³⁾ When L-shaped thrust collars (See section for L-Shaped Thrust Collars starting on page B100 in Cat. RB/A/GB/...) are used, the bearings become the NH type.

Cylindrical Roller Bearings (Inch)

Bore Diameter $\frac{1}{2}$ – $1\frac{3}{8}$ Inch

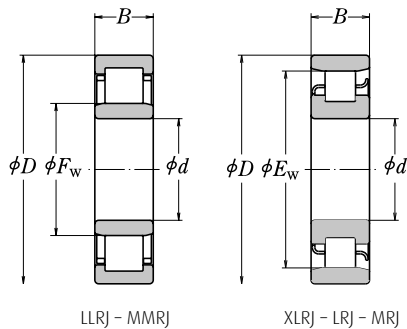

Boundary Dimensions (Inch)			Bearing Numbers	Basic Load Ratings (N)		Limiting Speeds (min ⁻¹)		Mass (kg) approx
d	D	B		C _r	C _{0r}	Grease	Oil	
1/2	1 1/16	3/8	LLRJ1/2	9 850	6 950	21 000	23 000	0,039
	1 1/16	3/8	LRJ1/2	9 850	6 950	12 700	21 000	0,038
	1 1/8	5/8	MMRJ1/2	17 100	12 800	9 900	20 000	0,119
	1 1/8	5/8	MRJ1/2	17 100	12 800	10 800	18 000	0,107
5/8	1 1/16	7/16	LLRJ5/8	12 500	9 950	18 000	24 000	0,067
	1 1/16	7/16	LRJ5/8	12 500	9 950	18 000	18 000	0,066
	1 9/16	5/8	MMRJ5/8	18 800	14 800	16 000	22 000	0,143
	1 9/16	5/8	MRJ5/8	18 800	14 800	9 700	16 000	0,121
3/4	1 1/8	9/16	LLRJ3/4	22 800	19 400	15 500	20 500	0,123
	1 1/8	9/16	LRJ3/4	22 800	19 400	15 500	20 500	0,121
	2	1 1/16	MMRJ3/4	28 700	24 300	15 000	20 000	0,176
	2	1 1/16	MRJ3/4	28 700	24 300	15 000	20 000	0,172
7/8	2	9/16	LLRJ7/8	24 600	20 800	14 400	19 500	0,133
	2	9/16	LRJ7/8	24 600	20 800	14 400	19 500	0,13
	2 1/4	1 1/16	MMRJ7/8	25 100	21 100	12 900	17 500	0,235
	2 1/4	1 1/16	MRJ7/8	25 100	21 100	12 900	17 500	0,191
1	2 1/4	5/8	LLRJ1	31 100	27 900	12 900	17 500	0,189
	2 1/4	5/8	LRJ1	31 100	27 900	12 900	17 500	0,186
	2 1/2	3/4	MMRJ1	35 000	30 600	12 200	16 500	0,293
	2 1/2	3/4	MRJ1	35 000	30 600	12 200	16 500	0,288
1 1/8	2 1/2	5/8	LLRJ1 1/8	33 100	31 300	11 600	15 500	0,238
	2 1/2	5/8	LRJ1 1/8	33 100	31 300	11 600	15 500	0,235
	2 9/16	7/16	MMRJ1 1/8	45 500	41 900	10 500	14 100	0,4
	2 9/16	7/16	MRJ1 1/8	45 500	41 900	10 500	14 100	0,393
1 1/4	2 3/4	1 1/16	LLRJ1 1/4	42 100	37 900	10 600	14 300	0,303
	2 3/4	1 1/16	LRJ1 1/4	42 100	37 900	10 600	14 300	0,298
	3 1/8	7/8	MMRJ1 1/4	58 000	52 500	9 400	12 700	0,521
	3 1/8	7/8	MRJ1 1/4	58 000	52 500	9 400	12 700	0,511
1 3/8	3	1 1/16	LLRJ1 3/8	42 100	38 300	10 100	13 700	0,371
	3	1 1/16	LRJ1 3/8	42 100	38 300	10 100	13 700	0,366
	3 1/2	7/8	MMRJ1 3/8	66 000	57 500	8 900	12 000	0,67
	3 1/2	7/8	MRJ1 3/8	66 000	57 500	8 900	12 000	0,659

Cylindrical Roller Bearings (Inch)

Bore Diameter 1 1/2 – 2 1/2 Inch



Boundary Dimensions (Inch)			Bearing Numbers	Basic Load Ratings (N)		Limiting Speeds (min ⁻¹)		Mass (kg)
d	D	B		C _r	C _{0r}	Grease	Oil	approx
1 1/2	2 1/16	3/16	XLRJ1 1/2	23 300	24 300	6 200	10 300	0,219
	3/4	3/4	LLRJ1 1/2	54 000	48 800	9 000	12 100	0,451
	3/4	3/4	LRJ1 1/2	54 000	48 800	9 000	12 100	0,443
	3 3/4	5/16	MMRJ1 1/2	72 500	68 500	8 300	11 200	0,853
	3 3/4	5/16	MRJ1 1/2	72 500	68 500	8 300	11 200	0,841
1 5/8	2 7/8	3/16	XLRJ1 5/8	24 000	25 900	5 700	9 600	0,25
	3 1/2	3/4	LLRJ1 5/8	57 500	54 000	8 400	11 300	0,538
	3 1/2	3/4	LRJ1 5/8	57 500	54 000	8 400	11 300	0,53
	4	5/16	MMRJ1 5/8	73 000	72 500	4 100	8 200	1,03
	4	5/16	MRJ1 5/8	85 500	83 000	4 500	7 500	0,971
1 3/4	3	3/16	XLRJ1 3/4	24 700	27 500	5 500	9 000	0,264
	3 3/4	5/16	LLRJ1 3/4	68 000	63 000	7 800	10 500	0,647
	3 3/4	5/16	LRJ1 3/4	68 000	63 000	7 800	10 500	0,637
	4 1/4	1 1/16	MMRJ1 3/4	98 000	93 000	7 000	9 500	1,29
	4 1/4	1 1/16	MRJ1 3/4	98 500	93 000	7 200	9 700	1,19
1 7/8	3 3/16	5/8	XLRJ1 7/8	34 000	35 800	1 300	8 600	0,334
	4	5/16	LLRJ1 7/8	72 000	79 000	7 100	9 600	0,805
	4	5/16	LRJ1 7/8	72 000	79 000	7 100	9 600	0,798
	4 1/2	1 1/16	MMRJ1 7/8	98 500	94 500	6 800	9 200	1,35
	4 1/2	1 1/16	MRJ1 7/8	98 500	94 500	6 800	9 200	1,33
2	3 3/16	5/8	XLRJ2	35 300	38 200	4 900	8 200	0,333
	4	5/16	LLRJ2	72 000	79 000	7 100	9 600	0,765
	4	5/16	LRJ2	72 000	79 000	7 100	9 600	0,758
	4 1/2	1 1/16	MMRJ2	98 500	94 500	6 800	9 200	1,3
	4 1/2	1 1/16	MRJ2	98 500	94 500	6 800	9 200	1,28
2 1/4	3 3/16	5/8	XLRJ2 1/4	39 100	45 000	4 500	7 500	0,369
	4 1/2	7/8	LLRJ2 1/4	87 500	89 500	6 400	8 600	1,04
	4 1/2	7/8	LRJ2 1/4	87 500	89 500	6 400	8 600	1,01
	5	1 1/4	MMRJ2 1/4	136 000	138 000	5 800	7 800	1,83
	5	1 1/4	MRJ2 1/4	136 000	138 000	5 800	7 800	1,8
2 1/2	3 7/8	1 1/16	XLRJ2 1/2	42 600	52 000	4 100	6 800	0,472
	5	5/16	LLRJ2 1/2	86 500	97 500	5 800	7 800	1,48
	5	5/16	LRJ2 1/2	102 000	114 000	5 500	7 500	1,36
	5 1/2	1 1/4	MMRJ2 1/2	164 000	167 000	5 200	7 100	2,2
	5 1/2	1 1/4	MRJ2 1/2	164 000	167 000	5 200	7 100	2,17

Cylindrical Roller Bearings (Inch)

Bore Diameter $2\frac{3}{4}$ – 4 Inch

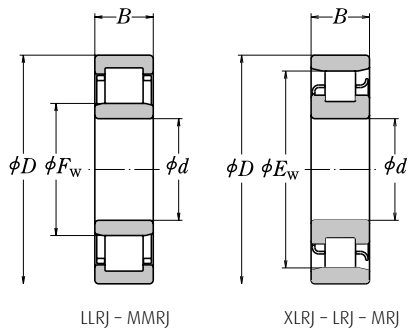

Boundary Dimensions (Inch)			Bearing Numbers	Basic Load Ratings (N)		Limiting Speeds (min ⁻¹)		Mass (kg) approx
d	D	B		C _r	C _{0r}	Grease	Oil	
2¾	4¾	¾	XLRj2¾	42 100	52 500	3 800	6 300	0,508
	5¼	¾	LLRj2¾	93 000	110 000	5 300	7 200	1,58
	5¼	¾	LRj2¾	107 000	122 000	5 300	7 200	1,48
	6¼	1¾	MMRj2¾	170 000	189 000	4 700	6 400	3,56
	6¼	1¾	MRj2¾	205 000	216 000	2 800	4 700	3,42
3	4½	¾	XLRj3	56 000	68 500	3 400	5 700	0,631
	5¾	1¼	LLRj3	139 000	147 000	4 900	6 600	1,93
	5¾	1¼	LRj3	139 000	147 000	4 900	6 600	1,91
	7	1¾	MMRj3	234 000	248 000	2 700	4 500	4,8
	7	1¾	MRj3	234 000	248 000	4 200	5 700	4,74
3¼	4¾	¾	XLRj3¼	59 500	75 000	3 200	5 400	0,671
	6	1¼	LLRj3¼	115 000	140 000	4 600	6 200	2,24
	6	1¼	LRj3¼	151 000	172 000	2 700	4 600	2,14
	7½	1¾	MMRj3¼	245 000	273 000	2 500	4 200	5,76
	7½	1¾	MRj3¼	263 000	285 000	2 300	3 900	5,67
3¾	7½	1¾	MMRj3¾	245 000	273 000	2 500	4 200	5,62
	7½	1¾	MRj3¾	263 000	285 000	2 300	3 900	5,58
3½	5	¾	XLRj3½	60 500	78 500	3 000	5 100	0,712
	6½	1¼	LLRj3½	168 000	189 000	4 200	5 700	2,58
	6½	1¼	LRj3½	168 000	189 000	4 200	5 700	2,56
	8¾	1¾	MMRj3½	276 000	311 000	3 500	4 700	7,8
	8¾	1¾	MRj3½	276 000	311 000	2 100	3 500	7,48
3¾	5¼	¾	XLRj3¾	62 000	82 500	2 800	4 700	0,758
	6¾	1¼	LLRj3¾	145 000	181 000	4 000	5 400	2,94
	6¾	1¼	LRj3¾	192 000	230 000	2 400	3 900	2,8
	8¼	1¾	MMRj3¾	276 000	311 000	3 500	4 700	7,85
	8¼	1¾	MRj3¾	276 000	311 000	2 100	3 500	7,53
4	5¾	¾	XLRj4	80 000	105 000	2 600	4 400	1,03
	7¼	1¼	LLRj4	173 000	219 000	3 600	4 800	3,78
	7¼	1¼	LRj4	173 000	219 000	2 100	3 600	3,6
	8½	1¾	MMRj4	302 000	359 000	3 100	4 200	8,12
	8½	1¾	MRj4	302 000	359 000	1 900	3 100	7,8

Cylindrical Roller Bearings (Inch)

Bore Diameter 4¹/₄ – 6 Inch

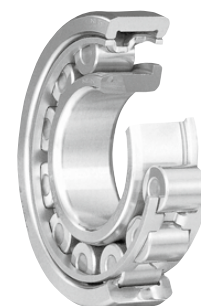

Boundary Dimensions (Inch)			Bearing Numbers	Basic Load Ratings (N)		Limiting Speeds (min ⁻¹)		Mass (kg)
d	D	B		C _r	C _{0r}	Grease	Oil	approx
4 ¹ / ₄	6	7/8	XLRJ4 ¹ / ₄	84 000	114 000	2 500	4 100	1,22
	7 ¹ / ₂	1 ¹ / ₄	LLRJ4 ¹ / ₄	222 000	270 000	3 500	4 800	4,42
	7 ¹ / ₂	1 ¹ / ₄	LRJ4 ¹ / ₄	222 000	270 000	2 100	3 500	3,77
	8 ³ / ₄	1 ³ / ₄	MMRJ4 ¹ / ₄	302 000	359 000	3 100	4 200	8,48
	8 ³ / ₄	1 ³ / ₄	MRJ4 ¹ / ₄	302 000	359 000	1 900	3 100	8,16
4 ¹ / ₂	6 ¹ / ₄	7/8	XLRJ4 ¹ / ₂	80 000	124 000	2 300	3 900	1,24
	8	1 ¹ / ₁₆	LLRJ4 ¹ / ₂	211 000	273 000	3 200	4 400	4,81
	8	1 ¹ / ₁₆	LRJ4 ¹ / ₂	229 000	288 000	1 900	3 200	4,67
	9 ³ / ₈	2	MMRJ4 ¹ / ₂	359 000	423 000	2 900	3 900	11,1
	9 ³ / ₈	2	MRJ4 ¹ / ₂	417 000	478 000	1 700	2 900	10,8
4 ³ / ₄	6 ¹ / ₂	7/8	XLRJ4 ³ / ₄	92 000	133 000	2 200	3 700	1,3
	8 ¹ / ₄	1 ¹ / ₁₆	LLRJ4 ³ / ₄	210 000	274 000	3 100	4 200	4,81
	8 ¹ / ₄	1 ¹ / ₁₆	LRJ4 ³ / ₄	264 000	331 000	1 900	3 100	4,81
	10	2	MMRJ4 ³ / ₄	374 000	456 000	2 600	3 500	13,1
	10	2	MRJ4 ³ / ₄	478 000	568 000	1 500	2 600	12,3
5	7	1	XLRJ5	113 000	161 000	2 100	3 400	1,81
	9	1 ³ / ₁₆	LLRJ5	243 000	322 000	2 800	3 800	6,53
	9	1 ³ / ₁₆	LRJ5	281 000	369 000	1 700	2 800	6,49
	10	2	MMRJ5	374 000	456 000	2 600	3 500	12,3
	10	2	MRJ5	478 000	568 000	1 500	2 600	11,7
5 ¹ / ₄	7 ¹ / ₄	1	XLRJ5 ¹ / ₄	112 000	161 000	2 000	3 300	1,87
5 ¹ / ₂	7 ¹ / ₂	1	XLRJ5 ¹ / ₂	117 000	174 000	1 900	3 100	1,97
	9 ¹ / ₂	1 ³ / ₁₆	LLRJ5 ¹ / ₂	249 000	339 000	2 600	3 500	6,89
	9 ¹ / ₂	1 ³ / ₁₆	LRJ5 ¹ / ₂	288 000	389 000	1 600	2 600	6,71
	11	2	MMRJ5 ¹ / ₂	448 000	573 000	2 300	3 100	15,3
	11	2	MRJ5 ¹ / ₂	545 000	668 000	2 300	3 100	15,1
5 ³ / ₄	7 ³ / ₄	1	XLRJ5 ³ / ₄	122 000	186 000	1 800	3 000	2,05
6	8	1	XLRJ6	127 000	198 000	1 700	2 800	2,11
	10 ¹ / ₂	1 ¹ / ₁₆	LLRJ6	325 000	450 000	2 200	3 000	9,71
	10 ¹ / ₂	1 ¹ / ₁₆	LRJ6	325 000	450 000	1 300	2 200	9,62
	12	2 ¹ / ₄	MMRJ6	509 000	672 000	2 000	2 700	20,2
	12	2 ¹ / ₄	MRJ6	640 000	795 000	1 000	2 000	19,6

Cylindrical Roller Bearings (Inch)

Bore Diameter 6½ – 10 Inch

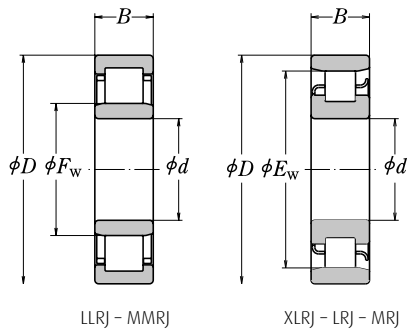

Boundary Dimensions (Inch)			Bearing Numbers	Basic Load Ratings (N)		Limiting Speeds (min ⁻¹)		Mass (kg) approx
d	D	B		C _r	C _{0r}	Grease	Oil	
6½	8¾	1½	XLRJ6½	131 000	211 000	1 500	2 600	2,97
	11	1¾	LLRJ6½	334 000	471 000	2 200	2 900	10,3
	11	1¾	LRJ6½	369 000	509 000	1 100	2 200	9,98
	13	2½	MMRJ6½	638 000	805 000	1 900	2 500	26,3
	13	2½	MRJ6½	749 000	940 000	1 900	2 500	26,6
7	9½	1¼	XLRJ7	194 000	307 000	1 200	2 300	4,08
	12	1¾	LLRJ7	477 000	645 000	1 900	2 600	15,6
	12	1¾	LRJ7	477 000	645 000	950	1 900	14,1
	13½	2½	MRJ7	747 000	950 000	900	1 800	27,5
7½	10	1¼	XLRJ7½	200 000	327 000	1 100	2 100	4,31
	12½	1¾	LLRJ7½	508 000	712 000	1 800	2 400	16,1
	12½	1¾	LRJ7½	508 000	712 000	1 100	1 800	14,7
	14½	2¾	MRJ7½	838 000	1 100 000	800	1 600	35
8	10¾	1¾	XLRJ8	230 000	373 000	1 000	2 000	5,72
	13	1¾	LLRJ8	443 000	657 000	1 700	2 300	15,5
	13	1¾	LRJ8	537 000	779 000	1 000	1 700	15,6
	15	2¾	MRJ8	870 000	1 170 000	750	1 500	36,7
8½	11½	1½	XLRJ8½	259 000	417 000	900	1 800	7,12
	14	2	LLRJ8½	531 000	786 000	1 500	2 100	20,6
	14	2	LRJ8½	531 000	786 000	900	1 500	21
	16	3	MRJ8½	959 000	1 280 000	850	1 400	46,3
9	12	1½	XLRJ9	269 000	445 000	850	1 700	7,53
	14½	2	LLRJ9	644 000	952 000	1 500	2 000	24
	14½	2	LRJ9	644 000	952 000	900	1 500	21,9
	17	3	MRJ9	1 065 000	1 460 000	1 300	1 700	52,6
9½	12¾	1¾	XLRJ9½	313 000	521 000	950	1 600	9,34
	15½	2	LLRJ9½	556 000	856 000	1 400	1 900	26
	15½	2	LRJ9½	556 000	856 000	1 400	1 900	23,7
	18	3¼	MRJ9½	1 230 000	1 640 000	1 200	1 600	63,1
10	13¾	1¾	XLRJ10	310 000	523 000	900	1 500	9,21
	15¾	2	LLRJ10	674 000	1 040 000	1 300	1 700	29,6
	15¾	2	LRJ10	674 000	1 040 000	750	1 300	25,2
	18½	3¼	MRJ10	1 190 000	1 650 000	1 100	1 500	64,9

Cylindrical Roller Bearings (Inch)

Bore Diameter 10¹/₂ – 16 Inch



Boundary Dimensions (Inch)			Bearing Numbers	Basic Load Ratings (N)		Limiting Speeds (min ⁻¹)		Mass (kg)
d	D	B		C _r	C _{0r}	Grease	Oil	approx
10 ¹ / ₂	14	1 ³ / ₄	XLRJ10 ¹ / ₂	373 000	640 000	700	1 400	11,8
	16 ⁵ / ₈	2 ¹ / ₄	LLRJ10 ¹ / ₂	669 000	1 050 000	1 200	1 600	31,8
	16 ⁵ / ₈	2 ³ / ₄	LRJ10 ¹ / ₂	671 000	1 020 000	1 200	1 600	30,8
	19 ¹ / ₂	3 ¹ / ₂	MRJ10 ¹ / ₂	1 330 000	1 870 000	1 000	1 400	79,4
11	14 ¹ / ₂	1 ³ / ₄	XLRJ11	386 000	678 000	650	1 300	12,4
	17 ¹ / ₂	2 ¹ / ₄	LLRJ11	706 000	1 110 000	1 100	1 500	35,8
	17 ¹ / ₂	2 ³ / ₄	LRJ11	706 000	1 110 000	1 100	1 500	35,5
	20	3 ¹ / ₂	MRJ11	1 330 000	1 880 000	1 000	1 300	81,6
11 ¹ / ₂	15 ³ / ₄	1 ⁷ / ₈	XLRJ11 ¹ / ₂	423 000	736 000	600	1 200	15
	18	2 ¹ / ₂ ³ / ₂	LRJ11 ¹ / ₂	839 000	1 310 000	1 100	1 400	38,3
12	16	2	XLRJ12	477 000	836 000	550	1 100	17,7
	18 ¹ / ₂	2 ⁵ / ₈	LLRJ12	839 000	1 310 000	1 000	1 400	43,2
	18 ¹ / ₂	2 ⁵ / ₈	LRJ12	858 000	1 360 000	1 000	1 400	42,6
	21 ¹ / ₂	3 ¹ / ₄	MRJ12	1 720 000	2 480 000	900	1 200	101
13	17 ¹ / ₂	2 ¹ / ₄	XLRJ13	571 000	993 000	600	1 000	24,7
	20	2 ³ / ₄	LLRJ13	975 000	1 560 000	900	1 200	53,5
	20	2 ³ / ₄	LRJ13	1 030 000	1 680 000	900	1 200	54,4
14	18 ¹ / ₂	2 ¹ / ₄	XLRJ14	564 000	998 000	550	950	25,4
	21 ¹ / ₂	2 ⁷ / ₈	LLRJ14	1 190 000	1 960 000	800	1 100	64,4
	21 ¹ / ₂	2 ⁷ / ₈	LRJ14	1 190 000	1 190 000	800	1 100	65,3
15	20	2 ¹ / ₂	XLRJ15	705 000	1 260 000	500	850	34,9
	22 ¹ / ₂	3	LLRJ15	1 120 000	1 830 000	750	1 000	70,3
	22 ¹ / ₂	3	LRJ15	1 220 000	1 940 000	750	1 000	70,8

Tapered Roller Bearings

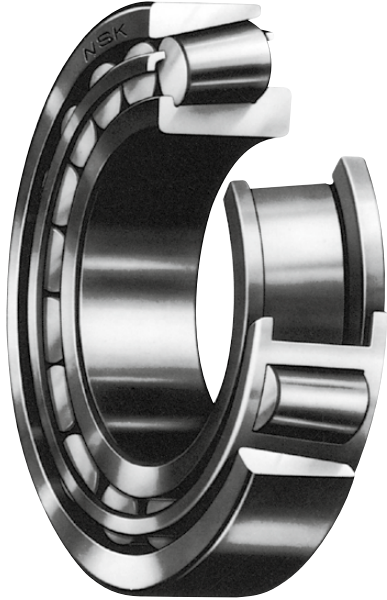

Series
 30200 32200
 30300 32300
 31300 32900
 32000 33000
 33100
 33200

Contact Angle
 Blank: Standard angle = 15° to 17°
 C: Medium angle = 17° to 24°
 D: Steep angle = 24° and more

HR

322

10

C

J

Prefix
 HR: High Capacity

Bore Size
 (04 and up: multiply last two numbers
 by 5 to get bore in mm)
 02: 12 mm 08: 40 mm
 03: 17 mm 10: 50 mm
 04: 20 mm 20: 100 mm
 Special bore sizes are as follows:
 /22: 22 mm /32: 32 mm
 /28: 28 mm

Interchangeability
 J: Cup angle and raceway
 diameter conform to ISO 355
 X: Dimension series 32000 and
 32900 the major dimensions
 conform to ISO 355

Please refer to the bearing tables for exact part number options

Design, Types and Features

Tapered roller bearings are designed so the apices of the cones formed by the raceways of the cone and cup and the conical rollers all coincide at one point on the axis of the bearing. When a radial load is imposed, an axial force component occurs; therefore, it is necessary to use two bearings in opposition or some other multiple arrangement. For metric-design medium-angle and steep-angle tapered roller bearings, the respective contact angle symbol C or D is added after the bore number.

For normal-angle tapered roller bearings, no contact angle symbol is used.

Medium-angle tapered roller bearings are primarily used for the pinion shafts of differential gears of automobiles.

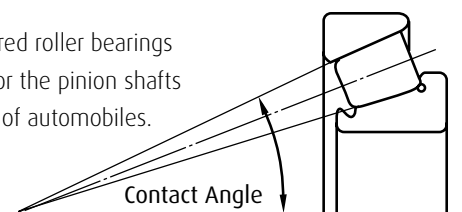

Design and Featured of Combinations of Tapered Roller Bearings

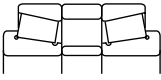
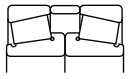
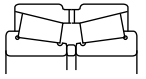
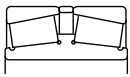
	Arrangement	Examples of Bearing No.	Features
	Back-to-back	HR30210JDB+KLR10	Two standard bearings are combined. The bearing clearances are adjusted by cone spacers or cup spacers. The cones and cups and spacers are marked with serial numbers and mating marks. Components with the same serial number can be assembled referring to the matching symbols.
	Face-to-face	HR30210JDF+KR	
	KBE Type	100KBE31+L	The KBE type is a back-to-back arrangement of bearings with the cup and spacer integrated, and the KH type is a face-to-face arrangement in which the cones are integrated. Since the bearing clearance is adjusted using spacers, it is necessary for components to have the same serial number for assembly with reference to matching symbols.
	KH Type	110KH31+K	

Tapered Roller Bearings

Inch



Code Included Cup Angle

1	0	bis 23°59'59.99"
2	24°	bis 25°29'59.99"
3	25°30'	bis 26°59'59.99"
4	27°	bis 28°29'59.99"
5	28°30'	bis 30°29'59.99"
6	30°30'	bis 32°29'59.99"
7	32°30'	bis 35°59'59.99"
8	36°	bis 44°59'59.99"
9	45° up, but not thrust only	

Design Number
2 digits which identify
the cup or cone

LM

Prefix
EH: Extra heavy
EL: Extra light
H: Heavy
HH: Heavier than heavy
HM: Heavy medium
J: Metric designed
L: Light
LL: Lighter than light
LM: Light medium
M: Medium

1

Basic Series
1-3 digit number that identifies
maximum bore range

19

49

R

Additional Features*
R: Conforms to AFBMA standard
G: Case carburized cups & cone
*NSK uses these two standard suffixes.
Either one or two letter suffixes may appear.

Please refer to the bearing tables for exact part number options

Shown below are some common applications utilizing a tapered roller bearing design. The design allows for combinations of heavy radial and thrust loads with low to moderate speeds. This section covers only single row tapers although NSK manufactures a full line of two and four row tapers as well. For more details on multiple row tapered roller bearings, please see the Rolling Mill section of this catalog or contact an NSK representative.

Metric designs function the same as their inch series cousins,

the difference lies in the units of measure. NSK metric tapers are standardly supplied with cup and cone together, while inch series bearings are available by the cup, cone, or cup and cone. The applications shown below are for either metric or inch bearings, with the equipment manufacturer choosing the preference of dimensional measurements. Metric tapers are usually found in equipment designed in Europe or Asia.

Applications

- › Guide Boxes in Bar and Rod Mills › Pumps and Compressors › Cranes and Hoists › Gears and Drives
- › Stamping Presses › Machine Tool Spindles › Bow Thrusts on Ships › Speed Reducers › Transmissions › Sheaves
- › Conveyor and Transfer Equipment › Coupling Equipment › Construction Equipment › Mining Equipment
- › Oil Field Equipment › Automotive Front and Rear Axles › Plastic Forming Equipment › Agriculture Equipment
- › Motorcycle Wheels › Pinion Shafts of Differential Gears › Drum Shafts › Crankshafts › Crushers

Tapered Roller Bearings

Bore Diameter 15 – 28 mm

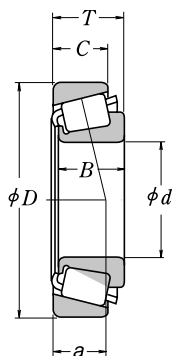

Boundary Dimensions (mm)					Basic Load Ratings (N)		Limiting Speeds (min ⁻¹)		Bearing Numbers	Mass (kg)
d	D	T	B	C	C _r	C _{0r}	Grease	Oil		approx
15	35	11,75	11	10	14 800	13 200	11 000	15 000	30202	0,053
	42	14,25	13	11	23 600	21 100	9 500	13 000	HR 30302 J	0,098
17	40	13,25	12	11	20 100	19 900	9 500	13 000	HR 30203 J	0,079
	40	17,25	16	14	27 100	28 000	9 500	13 000	HR 32203 J	0,103
	47	15,25	14	12	29 200	26 700	8 500	12 000	HR 30303 J	0,134
	47	15,25	14	10,5	22 000	20 300	8 000	11 000	30303 D	0,129
	47	20,25	19	16	37 500	36 500	8 500	11 000	HR 32303 J	0,178
20	42	15	15	12	24 600	27 400	9 000	12 000	HR 32004 XJ	0,097
	47	15,25	14	12	27 900	28 500	8 000	11 000	HR 30204 J	0,127
	47	15,25	14	12	23 900	24 000	8 000	11 000	HR 30204 C-A-	0,126
	47	19,25	18	15	35 500	37 500	8 500	11 000	HR 32204 J	0,161
	47	19,25	18	15	31 500	33 500	8 000	11 000	HR 32204 CJ	0,166
	52	16,25	15	13	35 000	33 500	7 500	10 000	HR 30304 J	0,172
	52	16,25	15	12	25 300	24 500	7 100	10 000	30304 D	0,168
	52	22,25	21	18	45 500	47 500	8 000	11 000	HR 32304 J	0,241
22	44	15	15	11,5	25 600	29 400	8 500	11 000	HR 320/22 XJ	0,103
	50	15,25	14	12	29 200	30 500	7 500	10 000	HR 302/22	0,139
	50	15,25	14	12	27 200	29 500	7 500	10 000	HR 302/22 C	0,144
	50	19,25	18	15	36 500	40 500	7 500	11 000	HR 322/22	0,18
	50	19,25	18	15	33 500	39 500	7 500	10 000	HR 322/22 C	0,185
	56	17,25	16	14	37 000	36 500	7 100	9 500	HR 303/22	0,208
	56	17,25	16	13	34 500	34 000	6 700	9 500	HR 303/22 C	0,207
25	47	15	15	11,5	27 400	33 000	8 000	11 000	HR 32005 XJ	0,116
	47	17	17	14	31 000	38 000	8 000	11 000	HR 33005 J	0,131
	52	16,25	15	13	32 000	35 000	7 100	10 000	HR 30205 J	0,157
	52	16,25	15	12	28 100	31 500	9 700	9 500	HR 30205 C	0,155
	52	19,25	18	16	40 000	45 000	7 100	10 000	HR 32205 J	0,189
	52	19,25	18	15	35 000	42 000	7 100	9 500	HR 32205 C	0,19
	52	22	22	18	47 500	56 500	7 500	10 000	HR 33205 J	0,221
	62	18,25	17	15	47 500	46 000	6 300	8 500	HR 30305 J	0,27
	62	18,25	17	14	42 000	45 000	6 000	8 500	HR 30305 C	0,276
	62	18,25	17	13	38 000	40 500	5 600	8 000	HR 30305 DJ	0,265
	62	18,25	17	13	38 000	40 500	5 600	8 000	HR 31305 J	0,265
	62	25,25	24	20	62 500	66 000	6 300	8 500	HR 32305 J	0,376
28	52	16	16	12	32 000	39 000	7 100	9 500	HR 320/28 XJ	0,146
	58	17,25	16	14	39 500	41 500	6 300	9 000	HR 302/28	0,203
	58	17,25	16	12	34 000	38 500	6 300	8 500	HR 302/28 C	0,198
	58	20,25	19	16	47 500	54 000	6 300	9 000	HR 322/28	0,243
	58	20,25	19	16	42 000	49 500	6 300	9 000	HR 322/28 CJ	0,251
	68	19,75	18	15	55 000	55 500	6 000	8 000	HR 303/28	0,341
	68	19,75	18	14	49 500	50 500	5 600	7 500	HR 303/28 C	0,335

The suffix C represents medium-angle tapered roller bearings. Since they are designed for specific applications, please consult NSK when using bearings with suffix C.

Tapered Roller Bearings

Bore Diameter 30 – 35 mm



Boundary Dimensions (mm)					Basic Load Ratings (N)		Limiting Speeds (min ⁻¹)		Bearing Numbers	Mass (kg) approx
d	D	T	B	C	C _r	C _{0r}	Grease	Oil		
30	47	12	12	9	17 600	24 400	7 500	10 000	HR 32906 J	0,074
	55	17	17	13	36 000	44 500	6 700	9 000	HR 32006 XJ	0,172
	55	20	20	16	42 000	54 000	6 700	9 000	HR 33006 J	0,208
	62	17,25	16	14	43 000	47 500	6 000	8 000	HR 30206 J	0,238
	62	17,25	16	12	35 500	37 000	5 600	7 500	HR 30206 C	0,221
	62	21,25	20	17	52 000	60 000	6 000	8 500	HR 32206 J	0,297
	62	21,25	20	16	48 000	56 000	6 000	8 000	HR 32206 C	0,293
	62	25	25	19,5	66 500	79 500	6 000	8 000	HR 33206 J	0,355
	72	20,75	19	16	59 500	60 000	5 300	7 500	HR 30306 J	0,403
	72	20,75	19	14	56 500	55 500	5 300	7 100	HR 30306 C	0,383
	72	20,75	19	14	49 000	52 500	4 800	6 700	HR 30306 DJ	0,393
	72	20,75	19	14	49 000	52 500	4 800	6 800	HR 31306 J	0,393
	72	28,75	27	23	80 000	88 500	5 600	7 500	HR 32306 J	0,57
	72	28,75	27	23	76 000	86 500	5 600	7 500	HR 32306 CJ	0,583
32	58	17	17	13	37 500	47 000	6 300	8 500	HR 320/32 XJ	0,191
	58	21	20	16	41 000	50 000	6 300	8 500	330/32	0,225
	65	18,25	17	15	48 500	54 000	5 600	8 000	HR 302/32	0,277
	65	18,25	17	14	45 500	52 500	5 600	7 500	HR 302/32 C	0,273
	65	22,25	21	18	56 000	65 000	6 000	8 000	HR 322/32	0,336
	65	22,25	21	17	49 500	60 000	5 600	7 500	HR 322/32 C	0,335
	65	26	26	20,5	70 000	86 500	5 600	8 000	HR 332/32 J	0,40
	75	21,75	20	17	56 000	56 000	5 300	7 100	303/32	0,435
35	55	14	14	11,5	27 400	39 000	6 300	8 500	HR 32907 J	0,123
	62	18	18	14	43 500	55 500	5 600	8 000	HR 32007 XJ	0,229
	62	21	21	17	49 000	65 000	5 600	8 000	HR 33007 J	0,267
	72	18,25	17	15	54 000	59 500	5 300	7 100	HR 30207 J	0,34
	72	18,25	17	13	47 000	54 500	5 000	6 700	HR 30207 C	0,331
	72	24,25	23	19	70 500	83 500	5 300	7 100	HR 32207 J	0,456
	72	24,25	23	18	60 500	71 500	5 000	7 100	HR 32207 C	0,442
	72	28	28	22	86 500	108 000	5 300	7 100	HR 33207 J	0,54
	80	22,75	21	18	76 000	79 000	4 800	6 700	HR 30307 J	0,538
	80	22,75	21	16	68 000	70 500	4 800	6 300	HR 30307 C	0,518
	80	22,75	21	15	62 000	68 000	4 300	6 000	HR 30307 DJ	0,519
	80	22,75	21	15	62 000	68 000	4 300	6 000	HR 31307 J	0,52
	80	32,75	31	25	99 000	111 000	5 000	6 700	HR 32307 J	0,765

The suffix C represents medium-angle tapered roller bearings. Since they are designed for specific applications, please consult NSK when using bearings with suffix C.

Tapered Roller Bearings

Bore Diameter 40 – 50 mm

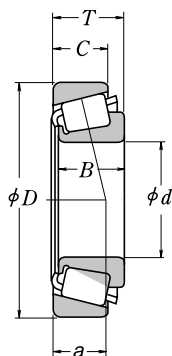

Boundary Dimensions (mm)					Basic Load Ratings (N)		Limiting Speeds (min ⁻¹)		Bearing Numbers	Mass (kg) approx
d	D	T	B	C	C _r	C _{0r}	Grease	Oil		
40	62	15	15	12	34 000	47 000	5 600	7 500	HR 32908 J	0,161
	68	19	19	14,5	53 000	71 000	5 300	7 100	HR 32008 XJ	0,28
	68	22	22	18	59 000	81 500	5 300	7 100	HR 33008 J	0,322
	75	26	26	20,5	78 500	101 000	4 800	6 700	HR 33108 J	0,503
	80	19,75	18	16	63 500	70 000	4 800	6 300	HR 30208 J	0,437
	80	24,75	23	19	77 000	90 500	4 800	6 300	HR 32208 J	0,548
	80	24,75	23	19	74 000	90 500	4 500	6 300	HR 32208 CJ	0,558
	80	32	32	25	107 000	137 000	4 800	6 300	HR 33208 J	0,744
	90	25,25	23	20	90 500	101 000	4 300	5 600	HR 30308 J	0,758
	90	25,25	23	18	84 500	93 500	4 300	5 600	HR 30308 C	0,735
	90	25,25	23	17	80 000	89 500	3 800	5 300	HR 30308 DJ	0,728
	90	25,25	23	17	80 000	89 500	3 800	5 300	HR 31308 J	0,728
90	35,25	33	27	120 000	145 000	4 300	6 000	HR 32308 J	1,05	
45	68	15	15	12	34 500	50 500	5 000	6 700	HR 32909 J	0,187
	75	20	20	15,5	60 000	83 000	4 500	6 300	HR 32009 XJ	0,354
	75	24	24	19	69 000	99 000	4 800	6 300	HR 33009 J	0,414
	80	26	26	20,5	84 000	113 000	4 500	6 000	HR 33109 J	0,552
	85	20,75	19	16	68 500	79 500	4 300	6 000	HR 30209 J	0,488
	85	24,75	23	19	83 000	102 000	4 300	6 000	HR 32209 J	0,602
	85	24,75	23	19	75 500	95 500	4 300	5 600	HR 32209 CJ	0,603
	85	32	32	25	111 000	147 000	4 300	6 000	HR 33209 J	0,817
	95	29	26,5	20	88 500	109 000	3 600	5 000	T7 FC045	0,918
	95	36	35	30	139 000	174 000	4 000	5 300	T2 ED045	1,22
	100	27,25	25	22	112 000	127 000	3 800	5 300	HR 30309 J	1,01
	100	27,25	25	18	95 500	109 000	3 400	4 800	HR 30309 DJ	0,957
	100	27,25	25	18	95 500	109 000	3 400	4 800	HR 31309 J	0,947
100	38,25	36	30	144 000	177 000	3 800	5 300	HR 32309 J	1,42	
50	100	36	35	30	144 000	185 000	3 800	5 000	T2 ED050	1,3
	72	15	15	12	36 000	54 000	4 500	6 300	HR 32910 J	0,193
	80	20	20	15,5	61 000	87 000	4 300	6 000	HR 32010 XJ	0,38
	80	24	24	19	70 500	104 000	4 300	6 000	HR 33010 J	0,452
	85	26	26	20	89 000	126 000	4 300	5 600	HR 33110 J	0,597
	90	21,75	20	17	76 000	91 500	4 000	5 300	HR 30210 J	0,557
	90	24,75	23	19	87 500	109 000	4 000	5 300	HR 32210 J	0,642
	90	24,75	23	18	77 500	102 000	3 800	5 300	HR 32210 CJ	0,655
	90	32	32	24,5	118 000	165 000	4 000	5 300	HR 33210 J	0,867
	105	32	29	22	109 000	133 000	3 200	4 500	T7 FC050	1,22
	110	29,25	27	23	130 000	148 000	3 400	4 800	HR 30310 J	1,28
	110	29,25	27	19	114 000	132 000	3 200	4 300	HR 30310 DJ	1,26
	110	29,25	27	19	114 000	132 000	3 200	4 300	HR 31310 J	1,26
	110	42,25	40	33	176 000	220 000	3 600	4 800	HR 32310 J	1,88
	110	42,25	40	33	164 000	218 000	3 400	4 800	HR 32310 CJ	1,93

The suffix C represents medium-angle tapered roller bearings. Since they are designed for specific applications, please consult NSK when using bearings with suffix C.

Tapered Roller Bearings

Bore Diameter 55 – 65 mm



Boundary Dimensions (mm)					Basic Load Ratings (N)		Limiting Speeds (min ⁻¹)		Bearing Numbers	Mass (kg) approx
d	D	T	B	C	C _r	C _{0r}	Grease	Oil		
55	80	17	17	14	45 500	74 500	4 300	5 600	HR 32911 J	0,282
	90	23	23	17,5	81 500	117 000	3 800	5 300	HR 32011 XJ	0,568
	90	27	27	21	91 500	138 000	3 800	5 300	HR 33011 J	0,657
	95	30	30	23	112 000	158 000	3 800	5 000	HR 33111 J	0,877
	100	22,75	21	18	94 500	113 000	3 600	5 000	HR 30211 J	0,736
	100	26,75	25	21	110 000	137 000	3 600	5 000	HR 32211 J	0,859
	100	35	35	27	141 000	193 000	3 600	5 000	HR 33211 J	1,18
	115	34	31	23,5	126 000	164 000	3 000	4 300	T7 FC055	1,58
	120	31,5	29	25	150 000	171 000	3 200	4 300	HR 30311 J	1,63
	120	31,5	29	21	131 000	153 000	2 800	4 000	HR 30311 DJ	1,58
	120	31,5	29	21	131 000	153 000	2 800	4 000	HR 31311 J	1,58
	120	45,5	43	35	204 000	258 000	3 200	4 300	HR 32311 J	2,39
	120	45,5	43	35	195 000	262 000	3 200	4 300	HR 32311 CJ	2,47
	60	85	17	17	14	49 000	84 500	3 800	5 300	HR 32912 J
95		23	23	17,5	85 500	127 000	3 600	5 000	HR 32012 XJ	0,608
95		27	27	21	96 000	150 000	3 600	5 000	HR 33012 J	0,713
100		30	30	23	115 000	166 000	3 400	4 800	HR 33112 J	0,91
110		23,75	22	19	104 000	123 000	3 400	4 500	HR 30212 J	0,930
110		29,75	28	24	131 000	167 000	3 400	4 500	HR 32212 J	1,18
110		38	38	29	166 000	231 000	3 400	4 500	HR 33212 J	1,56
125		37	33,5	26	151 000	197 000	2 800	3 800	T7 FC060	2,03
130		33,5	31	26	174 000	201 000	3 000	4 000	HR 30312 J	2,03
130		33,5	31	22	151 000	177 000	2 600	3 800	HR 30312 DJ	1,98
130		33,5	31	22	151 000	177 000	2 600	3 800	HR 31312 J	1,98
130		48,5	46	37	233 000	295 000	3 000	4 000	HR 32312 J	2,96
130		48,5	46	35	196 000	249 000	2 800	3 800	32312 C	2,86
65		90	17	17	14	49 000	86 500	3 600	5 000	HR 32913 J
	100	23	23	17,5	86 500	132 000	3 400	4 500	HR 32013 XJ	0,646
	100	27	27	21	97 500	156 000	3 400	4 500	HR 33013 J	0,76
	110	34	34	26,5	148 000	218 000	3 200	4 300	HR 33113 J	1,32
	120	24,75	23	20	122 000	151 000	3 000	4 000	HR 30213 J	1,18
	120	32,75	31	27	157 000	202 000	3 000	4 000	HR 32213 J	1,55
	120	41	41	32	202 000	282 000	3 000	4 000	HR 33213 J	2,04
	140	36	33	28	200 000	233 000	2 600	3 600	HR 30313 J	2,51
	140	36	33	23	173 000	205 000	2 400	3 400	HR 30313 DJ	2,43
	140	36	33	23	173 000	205 000	2 400	3 400	HR 31313 J	2,43
	140	51	48	39	267 000	340 000	2 800	3 800	HR 32313 J	3,6

The suffix C represents medium-angle tapered roller bearings. Since they are designed for specific applications, please consult NSK when using bearings with suffix C.

Tapered Roller Bearings

Bore Diameter 70 – 80 mm

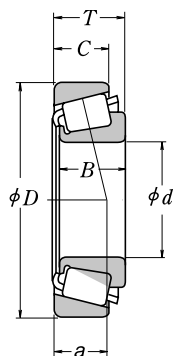

Boundary Dimensions (mm)					Basic Load Ratings (N)		Limiting Speeds (min ⁻¹)		Bearing Numbers	Mass (kg)	
d	D	T	B	C	C _r	C _{0r}	Grease	Oil		approx	
70	100	20	20	16	70 000	113 000	3 200	4 500	HR 32914 J	0,494	
	110	25	25	19	104 000	158 000	3 200	4 300	HR 32014 XJ	0,869	
	110	31	31	25,5	127 000	204 000	3 000	4 300	HR 33014 J	1,11	
	120	37	37	29	177 000	262 000	3 000	4 000	HR 33114 J	1,71	
	125	26,25	24	21	132 000	163 000	2 800	4 000	HR 30214 J	1,3	
	125	33,25	31	27	157 000	205 000	2 800	4 000	HR 32214 J	1,66	
	125	41	41	32	209 000	299 000	2 800	4 000	HR 33214 J	2,15	
	140	39	35,5	27	177 000	229 000	2 400	3 400	T7 FC070	2,55	
	150	38	35	30	227 000	268 000	2 400	3 400	HR 30314 J	3,03	
	150	38	35	25	192 000	229 000	2 200	3 200	HR 30314 DJ	2,94	
	150	38	35	25	192 000	229 000	2 200	3 200	HR 31314 J	2,94	
	150	54	51	42	300 000	390 000	2 600	3 400	HR 32314 J	4,35	
	150	54	51	42	280 000	390 000	2 400	3 400	HR 32314 CJ	4,47	
	75	105	20	20	16	72 500	120 000	3 200	4 300	HR 32915 J	0,53
115		25	25	19	109 000	171 000	3 000	4 000	HR 32015 XJ	0,925	
115		31	31	25,5	133 000	220 000	3 000	4 000	HR 33015 J	1,18	
125		37	37	29	182 000	275 000	2 800	3 800	HR 33115 J	1,8	
130		27,25	25	22	143 000	182 000	2 800	3 800	HR 30215 J	1,43	
130		33,25	31	27	165 000	219 000	2 800	3 800	HR 32215 J	1,72	
130		41	41	31	215 000	315 000	2 800	3 800	HR 33215 J	2,25	
160		40	37	31	253 000	300 000	2 400	3 200	HR 30315 J	3,63	
160		40	37	26	211 000	251 000	2 200	3 000	HR 30315 DJ	3,47	
160		40	37	26	211 000	251 000	2 200	3 000	HR 31315 J	3,47	
160		58	55	45	340 000	445 000	2 400	3 200	HR 32315 J	5,31	
160		58	55	43	310 000	420 000	2 200	3 200	32315 CA	5,3	
80		110	20	20	16	75 000	128 000	3 000	4 000	HR 32916 J	0,56
		125	29	29	22	140 000	222 000	2 800	3 600	HR 32016 XJ	1,32
	125	36	36	29,5	172 000	282 000	2 800	3 600	HR 33016 J	1,66	
	130	37	37	29	186 000	289 000	2 600	3 600	HR 33116 J	1,88	
	140	28,25	26	22	157 000	195 000	2 600	3 400	HR 30216 J	1,68	
	140	28,25	26	20	147 000	190 000	2 400	3 400	30216 CA	1,66	
	140	35,25	33	28	192 000	254 000	2 600	3 400	HR 32216 J	2,13	
	140	46	46	35	256 000	385 000	2 600	3 400	HR 33216 J	2,93	
	170	42,5	39	33	276 000	330 000	2 200	3 000	HR 30316 J	4,27	
	170	42,5	39	27	235 000	283 000	2 000	2 800	HR 30316 DJ	4,07	
	170	42,5	39	27	235 000	283 000	2 000	2 800	HR 31316 J	4,07	
	170	61,5	58	48	385 000	505 000	2 200	3 000	HR 32316 J	6,35	
	170	61,5	58	48	365 000	530 000	2 200	3 000	HR 32316 CJ	6,59	

The suffix C represents medium-angle tapered roller bearings. Since they are designed for specific applications, please consult NSK when using bearings with suffix C.

Tapered Roller Bearings

Bore Diameter 85 – 100 mm



Boundary Dimensions (mm)					Basic Load Ratings (N)		Limiting Speeds (min ⁻¹)		Bearing Numbers	Mass (kg) approx
d	D	T	B	C	C _r	C _{0r}	Grease	Oil		
85	120	23	23	18	93 500	157 000	2 800	3 800	HR 32917 J	0,8
	130	29	29	22	143 000	231 000	2 600	3 600	HR 32017 XJ	1,38
	130	36	36	29,5	180 000	305 000	2 600	3 600	HR 33017 J	1,75
	140	41	41	32	230 000	365 000	2 400	3 400	HR 33117 J	2,51
	150	30,5	28	24	184 000	233 000	2 400	3 200	HR 30217 J	2,12
	150	30,5	28	22	171 000	226 000	2 200	3 200	30217 CA	2,07
	150	38,5	36	30	210 000	277 000	2 200	3 200	HR 32217 J	2,64
	150	49	49	37	281 000	415 000	2 400	3 200	HR 33217 J	3,57
	180	44,5	41	34	310 000	375 000	2 000	2 800	HR 30317 J	5,08
	180	44,5	41	28	261 000	315 000	1 900	2 600	HR 30317 DJ	4,88
	180	44,5	41	28	261 000	315 000	1 900	2 600	HR 31317 J	4,88
	180	63,5	60	49	410 000	535 000	2 000	2 800	HR 32317 J	7,31
	90	125	23	23	18	97 000	167 000	2 600	3 600	HR 32918 J
140		32	32	24	170 000	273 000	2 400	3 200	HR 32018 XJ	1,78
140		39	39	32,5	220 000	360 000	2 400	3 200	HR 33018 J	2,21
150		45	45	35	259 000	405 000	2 400	3 200	HR 33118 J	3,14
160		32,5	30	26	201 000	256 000	2 200	3 000	HR 30218 J	2,6
160		42,5	40	34	256 000	350 000	2 200	3 000	HR 32218 J	3,41
190		46,5	43	36	345 000	425 000	1 900	2 600	HR 30318 J	5,91
190		46,5	43	30	264 000	315 000	1 800	2 400	HR 30318 DJ	5,52
190		46,5	43	30	264 000	315 000	1 800	2 400	HR 31318 J	5,52
190		67,5	64	53	450 000	590 000	2 000	2 600	HR 32318 J	8,6
95	130	23	23	18	98 000	172 000	2 400	3 400	HR 32919 J	0,877
	145	32	32	24	173 000	283 000	2 400	3 200	HR 32019 XJ	1,88
	145	39	39	32,5	231 000	390 000	2 400	3 200	HR 33019 J	2,3
	160	46	46	38	283 000	445 000	2 200	3 000	T2 ED095	3,74
	170	34,5	32	27	223 000	286 000	2 200	2 800	HR 30219 J	3,13
	170	45,5	43	37	289 000	400 000	2 200	2 800	HR 32219 J	4,22
	200	49,5	45	38	370 000	455 000	1 900	2 600	HR 30319 J	6,92
	200	49,5	45	36	350 000	430 000	1 800	2 400	30319 CA	6,71
	200	49,5	45	32	310 000	375 000	1 700	2 400	HR 30319 DJ	6,64
	200	49,5	45	32	310 000	375 000	1 700	2 400	HR 31319 J	6,64
	200	71,5	67	55	525 000	710 000	1 900	2 600	HR 32319 J	10,4
	100	140	25	25	20	117 000	205 000	2 200	3 200	HR 32920 J
145		24	22,5	17,5	113 000	163 000	2 200	3 000	T4 CB100	1,18
150		32	32	24	176 000	294 000	2 200	3 000	HR 32020 XJ	1,95
150		39	39	32,5	235 000	405 000	2 200	3 000	HR 33020 J	2,38
165		52	52	40	315 000	515 000	2 000	2 800	HR 33120 J	4,32
180		37	34	29	255 000	330 000	2 000	2 600	HR 30220 J	3,78
180		49	46	39	325 000	450 000	2 000	2 600	HR 32220 J	5,05
180		63	63	48	410 000	635 000	2 000	2 600	HR 33220 J	6,76
215		51,5	47	39	425 000	525 000	1 700	2 400	HR 30320 J	8,41
215		56,5	51	35	385 000	505 000	1 500	2 200	HR 31320 J	9,02
215		77,5	73	60	565 000	755 000	1 700	2 400	HR 32320 J	12,7

The suffix C represents medium-angle tapered roller bearings. Since they are designed for specific applications, please consult NSK when using bearings with suffix C.

Tapered Roller Bearings

Bore Diameter 105 – 130 mm

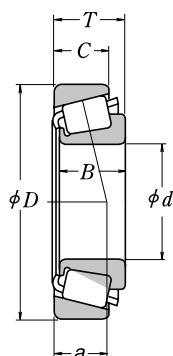

Boundary Dimensions (mm)					Basic Load Ratings (N)		Limiting Speeds (min ⁻¹)		Bearing Numbers	Mass (kg) approx
d	D	T	B	C	C _r	C _{0r}	Grease	Oil		
105	145	25	25	20	119 000	212 000	2 200	3 000	HR 32921 J	1,23
	160	35	35	26	204 000	340 000	2 000	2 800	HR 32021 XJ	2,48
	160	43	43	34	256 000	435 000	2 000	2 800	HR 33021 J	3,03
	190	39	36	30	280 000	365 000	1 900	2 600	HR 30221 J	4,51
	190	53	50	43	360 000	510 000	1 900	2 600	HR 32221 J	6,25
	225	53,5	49	41	455 000	565 000	1 600	2 200	HR 30321 J	9,52
	225	58	53	36	415 000	540 000	1 500	2 000	HR 31321 J	10
	225	81,5	77	63	670 000	925 000	1 700	2 200	HR 32321 J	14,9
110	150	25	25	20	123 000	224 000	2 200	2 800	HR 32922 J	1,29
	170	38	38	29	236 000	390 000	2 000	2 600	HR 32022 XJ	3,09
	170	47	47	37	294 000	515 000	2 000	2 600	HR 33022 J	3,84
	180	56	56	43	365 000	610 000	1 900	2 600	HR 33122 J	5,54
	200	41	38	32	315 000	420 000	1 800	2 400	HR 30222 J	5,28
	200	56	53	46	400 000	565 000	1 800	2 400	HR 32222 J	7,35
	240	54,5	50	42	485 000	595 000	1 500	2 000	HR 30322 J	11
	240	63	57	38	470 000	605 000	1 400	1 900	HR 31322 J	12,3
	240	84,5	80	65	675 000	910 000	1 500	2 000	HR 32322 J	17,1
120	165	29	29	23	161 000	291 000	1 900	2 600	HR 32924 J	1,8
	170	27	25	19,5	153 000	243 000	1 800	2 600	T4 CB120	1,78
	180	38	38	29	242 000	405 000	1 800	2 400	HR 32024 XJ	3,27
	180	48	48	38	300 000	540 000	1 800	2 600	HR 33024 J	4,2
	200	62	62	48	460 000	755 000	1 700	2 400	HR 33124 J	7,67
	215	43,5	40	34	335 000	450 000	1 600	2 200	HR 30224 J	6,28
	215	61,5	58	50	440 000	635 000	1 600	2 200	HR 32224 J	9,0
	260	59,5	55	46	535 000	655 000	1 400	1 900	HR 30324 J	13,9
	260	68	62	42	560 000	730 000	1 300	1 800	HR 31324 J	15,6
	260	90,5	86	69	770 000	1 060 000	1 400	1 900	HR 32324 J	21,8
130	180	32	30	26	167 000	281 000	1 800	2 400	32926	2,25
	180	32	32	25	200 000	365 000	1 800	2 400	HR 32926 J	2,46
	185	29	27	21	183 000	296 000	1 700	2 400	T4 CB130	2,32
	200	45	45	34	320 000	535 000	1 600	2 200	HR 32026 XJ	5,06
	200	55	55	43	395 000	715 000	1 700	2 200	HR 33026 J	6,25
	230	43,75	40	34	375 000	505 000	1 500	2 000	HR 30226 J	7,25
	230	67,75	64	54	530 000	790 000	1 500	2 000	HR 32226 J	11,3
	280	63,75	58	49	545 000	675 000	1 300	1 800	30326	16,6
	280	63,75	58	49	650 000	820 000	1 300	1 800	HR 30326 J	17,2
	280	72	66	44	625 000	820 000	1 200	1 700	HR 31326 J	18,8
	280	98,75	93	78	830 000	1 150 000	1 300	1 800	32326	26,6

The suffix C represents medium-angle tapered roller bearings. Since they are designed for specific applications, please consult NSK when using bearings with suffix C.

Tapered Roller Bearings

Bore Diameter 140 – 170 mm



Boundary Dimensions (mm)					Basic Load Ratings (N)		Limiting Speeds (min ⁻¹)		Bearing Numbers	Mass (kg)
d	D	T	B	C	C _r	C _{0r}	Grease	Oil		approx
140	190	32	32	25	206 000	390 000	1 700	2 200	HR 32928 J	2,64
	210	45	45	34	325 000	555 000	1 600	2 200	HR 32028 XJ	5,32
	210	56	56	44	410 000	770 000	1 600	2 200	HR 33028 J	6,74
	250	45,75	42	36	390 000	515 000	1 400	1 900	HR 30228 J	8,74
	250	71,75	68	58	610 000	915 000	1 400	1 900	HR 32228 J	14,3
	300	67,75	62	53	740 000	945 000	1 200	1 700	HR 30328 J	21,1
	300	77	70	47	695 000	955 000	1 100	1 500	HR 31328 J	28,5
	300	107,75	102	85	985 000	1 440 000	1 200	1 600	32328	33,9
150	210	38	36	31	247 000	440 000	1 500	2 000	32930	3,8
	210	38	38	30	281 000	520 000	1 500	2 000	HR 32930 J	4,05
	225	48	48	36	375 000	650 000	1 400	2 000	HR 32030 XJ	6,6
	225	59	59	46	435 000	805 000	1 400	2 000	HR 33030 J	8,07
	270	49	45	38	485 000	665 000	1 300	1 800	HR 30230 J	11,2
	270	77	73	60	705 000	1 080 000	1 300	1 800	HR 32230 J	17,8
	320	72	65	55	690 000	860 000	1 100	1 500	30330	24,2
	320	72	65	55	825 000	1 060 000	1 100	1 600	HR 30330 J	25
	320	82	75	50	790 000	1 100 000	1 000	1 400	HR 31330 J	28,5
	320	114	108	90	1 120 000	1 700 000	1 100	1 500	32330	41,4
160	220	38	38	30	296 000	570 000	1 400	1 900	HR 32932 J	4,32
	240	51	51	38	425 000	750 000	1 300	1 800	HR 32032 XJ	7,93
	290	52	48	40	530 000	730 000	1 200	1 600	HR 30232 J	13,7
	290	84	80	67	795 000	1 120 000	1 200	1 600	HR 32232 J	22,7
	340	75	68	58	765 000	960 000	1 000	1 400	30332	28,4
	340	75	68	58	870 000	1 110 000	1 100	1 400	HR 30332 J	29,2
	340	75	68	48	675 000	875 000	950	1 300	30332 D	27,5
340	121	114	95	1 210 000	1 770 000	1 000	1 400	32332	48,3	
170	230	38	36	31	258 000	485 000	1 300	1 800	32934	4,3
	230	38	38	30	294 000	560 000	1 400	1 800	HR 32934 J	4,44
	260	57	57	43	505 000	890 000	1 200	1 700	HR 32034 XJ	10,6
	310	57	52	43	630 000	885 000	1 100	1 500	HR 30234 J	17,1
	310	91	86	71	930 000	1 450 000	1 100	1 500	HR 32234 J	28
	360	80	72	62	845 000	1 080 000	950	1 300	30334	33,5
	360	80	72	62	960 000	1 230 000	1 000	1 300	HR 30334 J	34,5
	360	80	72	50	760 000	1 040 000	900	1 200	30334 D	33,4
	360	127	120	100	1 370 000	2 050 000	1 000	1 300	32334	57

The suffix C represents medium-angle tapered roller bearings. Since they are designed for specific applications, please consult NSK when using bearings with suffix C.

Tapered Roller Bearings

Bore Diameter 180 – 240 mm

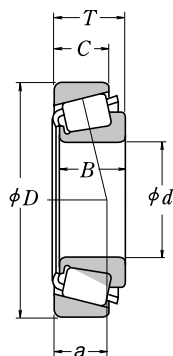

Boundary Dimensions (mm)					Basic Load Ratings (N)		Limiting Speeds (min ⁻¹)		Bearing Numbers	Mass (kg)
d	D	T	B	C	C _r	C _{0r}	Grease	Oil		approx
180	250	45	45	34	350 000	685 000	1 300	1 700	HR 32936 J	6,56
	280	64	64	48	640 000	1 130 000	1 200	1 600	HR 32036 XJ	14,3
	320	57	52	43	650 000	930 000	1 100	1 400	HR 30236 J	17,8
	320	91	86	71	960 000	1 540 000	1 100	1 400	HR 32236 J	29,8
	380	83	75	64	935 000	1 230 000	900	1 300	30336	39,3
	380	83	75	53	820 000	1 120 000	850	1 200	30336 D	38,5
	380	134	126	106	1 520 000	2 290 000	950	1 300	32336	66,8
190	260	45	45	34	365 000	715 000	1 200	1 600	HR 32938 J	6,83
	290	64	64	48	650 000	1 170 000	1 100	1 500	HR 32038 XJ	14,9
	340	60	55	46	760 000	1 080 000	1 000	1 300	HR 30238 J	21,4
	340	97	92	75	1 110 000	1 770 000	1 000	1 400	HR 32238 J	35,2
	400	86	78	65	1 010 000	1 340 000	850	1 200	30338	46
	400	140	132	109	1 660 000	2 580 000	850	1 200	32338	78,9
200	280	51	48	41	410 000	780 000	1 100	1 500	32940	9,26
	280	51	51	39	480 000	935 000	1 100	1 500	HR 32940 J	9,65
	310	70	70	53	760 000	1 370 000	1 000	1 400	HR 32040 XJ	18,9
	360	64	58	48	825 000	1 180 000	950	1 300	HR 30240 J	25,1
	360	104	98	82	1 210 000	1 920 000	950	1 300	HR 32240 J	42,6
	420	89	80	67	1 030 000	1 390 000	850	1 200	30340	52,3
	420	89	80	56	965 000	1 330 000	750	1 000	30340 D	49,6
	420	146	138	115	1 820 000	2 870 000	800	1 100	32340	90,9
220	300	51	51	39	490 000	990 000	1 000	1 400	HR 32944 J	10,3
	340	76	76	57	885 000	1 610 000	950	1 300	HR 32044 XJ	24,4
	400	72	65	54	810 000	1 150 000	850	1 100	30244	33,6
	400	114	108	90	1 340 000	2 210 000	850	1 100	32244	57,4
	460	97	88	73	1 430 000	1 990 000	750	1 000	30344	72,4
	460	154	145	122	2 020 000	3 200 000	750	1 000	32344	114
240	320	51	51	39	500 000	1 040 000	950	1 300	HR 32948 J	11,1
	360	76	76	57	920 000	1 730 000	850	1 200	HR 32048 XJ	26,2
	440	79	72	60	990 000	1 400 000	750	1 000	30248	45,2
	440	127	120	100	1 630 000	2 730 000	750	1 000	32248	78
	500	105	95	80	1 660 000	2 340 000	670	950	30348	92,6
	500	165	155	132	2 520 000	4 100 000	670	900	32348	145

The suffix C represents medium-angle tapered roller bearings. Since they are designed for specific applications, please consult NSK when using bearings with suffix C.

Tapered Roller Bearings

Bore Diameter 260 – 440 mm



Boundary Dimensions (mm)					Basic Load Ratings (N)		Limiting Speeds (min ⁻¹)		Bearing Numbers	Mass (kg) approx
d	D	T	B	C	C _r	C _{0r}	Grease	Oil		
260	360	63,5	63,5	48	730 000	1 450 000	850	1 100	HR 32952 J	18,6
	400	87	87	65	1 160 000	2 160 000	800	1 100	HR 32052 XJ	38,5
	480	89	80	67	1 190 000	1 700 000	670	900	30252	60,7
	480	137	130	106	1 900 000	3 300 000	670	950	32252	103
	540	113	102	85	1 870 000	2 640 000	630	850	30352	114
	540	176	165	136	2 910 000	4 800 000	630	850	32352	188
280	380	63,5	63,5	48	765 000	1 580 000	800	1 100	HR 32956 J	20
	420	87	87	65	1 180 000	2 240 000	710	1 000	HR 32056 XJ	40,6
	500	89	80	67	1 240 000	1 900 000	630	850	30256	66,3
	500	137	130	106	1 950 000	3 450 000	630	850	32256	109
	580	187	175	145	3 300 000	5 400 000	560	800	32356	224
300	420	76	72	62	895 000	1 820 000	710	950	32960	30,5
	420	76	76	57	1 010 000	2 100 000	710	950	HR 32960 J	31,4
	460	100	100	74	1 440 000	2 700 000	670	900	HR 32060 XJ	56,6
	540	96	85	71	1 440 000	2 100 000	600	800	30260	80,6
	540	149	140	115	2 220 000	3 700 000	600	800	32260	132
320	440	76	72	63	900 000	1 880 000	970	900	32964	32
	440	76	76	57	1 040 000	2 220 000	670	900	HR 32964 J	33,3
	480	100	100	74	1 510 000	2 910 000	630	850	HR 32064 XJ	60
	580	104	92	75	1 640 000	2 420 000	530	750	30264	99,3
	580	159	150	125	2 860 000	5 050 000	530	750	32264	175
	670	210	200	170	4 200 000	7 100 000	480	670	32364	343
340	460	76	72	63	910 000	1 940 000	630	850	32968	33,6
	460	76	76	57	1 050 000	2 220 000	630	850	HR 32968 J	34,3
	520	112	106	92	1 650 000	3 400 000	560	750	32068	83,7
360	480	76	72	62	945 000	2 100 000	600	800	32972	35,8
	480	76	76	57	1 080 000	2 340 000	560	800	HR 32972 J	36,1
	540	112	106	92	1 680 000	3 500 000	530	750	32072	86,5
380	520	87	82	71	1 210 000	2 550 000	560	750	32976	49,5
400	540	87	82	71	1 250 000	2 700 000	530	710	32980	52,7
	600	125	118	100	1 960 000	4 050 000	480	670	32080	116
420	560	87	82	72	1 300 000	2 810 000	500	670	32984	54,8
	620	125	118	100	2 000 000	4 200 000	450	630	32084	121
440	650	130	122	104	2 230 000	4 600 000	430	600	32088	136

The suffix C represents medium-angle tapered roller bearings. Since they are designed for specific applications, please consult NSK when using bearings with suffix C.

Tapered Roller Bearings (Inch)

Bore Diameter 12,000 – 22,225 mm

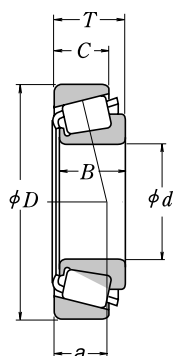

Boundary Dimensions (mm)					Basic Load Ratings (N)		Limiting Speeds (min ⁻¹)		Bearing Numbers		Mass (kg) approx	
d	D	T	B	C	C _r	C _{0r}	Grease	Oil	Cone	Cup	Cone	Cup
12,000	31,991	10,008	10,785	7,938	10 300	8 900	13 000	18 000	¹ A 2047	A 2126	0,023	0,017
12,700	34,988	10,998	10,988	8,730	11 700	10 900	12 000	16 000	A 4050	A 4138	0,033	0,022
15,000	34,988	10,998	10,988	8,730	11 700	10 900	12 000	16 000	¹ A 4059	A 4138	0,029	0,022
15,875	34,988	10,998	10,998	8,712	13 800	13 400	11 000	15 000	L 21549	L 21511	0,031	0,018
	39,992	12,014	11,153	9,525	14 900	15 700	9 500	13 000	A 6062	A 6157	0,044	0,031
	41,275	14,288	14,681	11,112	21 300	19 900	10 000	13 000	03062	03162	0,061	0,035
	42,862	14,288	14,288	9,525	17 300	17 200	8 500	12 000	11590	11520	0,061	0,040
	42,862	16,670	16,670	13,495	26 900	26 300	9 500	13 000	17580	17520	0,075	0,048
	44,450	15,494	14,381	11,430	23 800	23 900	8 500	11 000	05062	05175	0,081	0,039
	49,225	19,845	21,539	14,288	37 500	37 000	8 500	11 000	09062	09195	0,139	0,065
16,000	47,000	21,000	21,000	16,000	35 000	36 500	9 000	12 000	¹ HM 81649	² HM 81610	0,115	0,082
16,993	39,992	12,014	11,153	9,525	14 900	15 700	9 500	13 000	A 6067	A 6157	0,042	0,031
17,455	36,525	11,112	11,112	7,938	11 600	11 000	10 000	14 000	A 5069	A 5144	0,030	0,020
17,462	39,878	13,843	14,605	10,668	22 500	22 500	10 000	13 000	³ LM 11749	³ LM 11710	0,055	0,028
	47,000	14,381	14,381	11,112	23 800	23 900	8 500	11 000	05068	05185	0,082	0,047
19,050	39,992	12,014	11,153	9,525	14 900	15 700	9 500	13 000	A 6075	A 6157	0,037	0,031
	45,237	15,494	16,637	12,065	28 500	28 900	9 000	12 000	³ LM 11949	³ LM 11910	0,081	0,044
	47,000	14,381	14,381	11,112	23 800	23 900	8 500	11 000	05075	05185	0,077	0,047
	49,225	18,034	19,050	14,288	37 500	37 000	8 500	11 000	09067	09195	0,115	0,065
	49,225	19,845	21,539	14,288	37 500	37 000	8 500	11 000	09078	09195	0,124	0,065
	49,225	21,209	19,050	17,462	37 500	37 000	8 500	11 000	09067	09196	0,115	0,085
	49,225	23,020	21,539	17,462	37 500	37 000	8 500	11 000	09074	09194	0,124	0,082
	53,975	22,225	21,839	15,875	40 500	39 500	7 500	10 000	21075	21212	0,156	0,097
19,990	47,000	14,381	14,381	11,112	23 800	23 900	8 500	11 000	05079	05185	0,073	0,047
20,000	51,994	15,011	14,260	12,700	26 000	27 900	7 500	10 000	07079	07204	0,105	0,061
20,625	49,225	23,020	21,539	17,462	37 500	37 000	8 500	11 000	09081	09196	0,115	0,085
20,638	49,225	19,845	19,845	15,875	36 000	37 000	8 000	11 000	12580	12520	0,114	0,067
21,430	50,005	17,526	18,288	13,970	38 500	40 000	8 000	11 000	³ M 12649	³ M 12610	0,115	0,059
22,000	45,237	15,494	16,637	12,065	29 200	33 500	8 500	11 000	⁴ LM 12749	³ LM 12710	0,078	0,038
	45,975	15,494	16,637	12,065	29 200	33 500	8 500	11 000	⁴ LM 12749	³ LM 12711	0,078	0,043
22,225	50,005	13,495	14,260	9,525	26 000	27 900	7 500	10 000	07087	07196	0,097	0,035
	50,005	17,526	18,288	13,970	38 500	40 000	8 000	11 000	³ M 12648	³ M 12610	0,111	0,059
	52,388	19,368	20,168	14,288	40 500	43 000	7 500	10 000	1380	1328	0,137	0,067
	53,975	19,368	20,168	14,288	40 500	43 000	7 500	10 000	1380	1329	0,137	0,082
	56,896	19,368	19,837	15,875	38 000	40 500	7 100	9 500	1755	1729	0,152	0,102
	57,150	22,225	22,225	17,462	48 000	50 000	7 100	9 500	1280	1220	0,183	0,106

¹ The maximum bore diameter is listed and its tolerance is negative (See Table 8.4.1 on Page A68 in Cat. RB/A/GB/...).

² The maximum outside diameter is listed and its tolerance is negative (See Table 8.4.2 on Pages A68 and A69 in Cat. RB/A/GB/...).

³ The tolerances for the bore diameter and overall bearing width differ from the standard (See Table 5 on Page B110 in Cat. RB/A/GB/...).

⁴ The tolerance for the bore diameter is 0 to 20 µm, and for overall bearing width is +356 to 0 µm.

Tapered Roller Bearings (Inch)

Bore Diameter 22,606 – 28,575 mm



Boundary Dimensions (mm)					Basic Load Ratings (N)		Limiting Speeds (min ⁻¹)		Bearing Numbers		Mass (kg) approx	
d	D	T	B	C	C _r	C _{0r}	Grease	Oil	Cone	Cup	Cone	Cup
22,606	47,000	15,500	15,500	12,000	26 300	30 000	8 000	11 000	LM 72849	LM 72810	0,086	0,046
23,812	50,292	14,224	14,732	10,668	27 600	32 000	7 100	10 000	¹ L 44640	¹ L 44610	0,097	0,039
	56,896	19,368	19,837	15,875	38 000	40 500	7 100	9 500	1779	1729	0,143	0,102
24,000	55,000	25,000	25,000	21,000	49 500	55 000	7 100	9 500	² JHM 33449	² JHM 33410	0,181	0,107
24,981	51,994	15,011	14,260	12,700	26 000	27 900	7 500	10 000	07098	07204	0,085	0,061
	52,001	15,011	14,260	12,700	26 000	27 900	7 500	10 000	07098	07205	0,085	0,061
	62,000	16,002	16,566	14,288	37 000	39 500	6 300	8 500	17098	17244	0,165	0,091
25,000	50,005	13,495	14,260	9,525	26 000	27 900	7 500	10 000	07097	07196	0,085	0,035
	51,994	15,011	14,260	12,700	26 000	27 900	7 500	10 000	07097	07204	0,085	0,061
25,400	50,005	13,495	14,260	9,525	26 000	27 900	7 500	10 000	07100	SA 07196	0,082	0,035
	50,005	13,495	14,260	9,525	26 000	27 900	7 500	10 000	07100	07196	0,084	0,035
	50,292	14,224	14,732	10,668	27 600	32 000	7 100	10 000	¹ L 44643	¹ L 44610	0,090	0,039
	57,150	17,462	17,462	13,495	39 500	45 500	6 700	9 000	15578	15520	0,151	0,070
	57,150	19,431	19,431	14,732	42 500	49 000	6 700	9 000	M 84548	M 84510	0,156	0,089
	59,530	23,368	23,114	18,288	50 000	58 000	6 300	9 000	M 84249	M 84210	0,194	0,13
	62,000	19,050	20,638	14,288	46 000	53 000	6 000	8 000	15101	15245	0,222	0,081
	63,500	20,638	20,638	15,875	46 000	53 000	6 000	8 000	15100	15250 X	0,22	0,113
	64,292	21,433	21,433	16,670	51 000	64 500	5 600	8 000	M 86643	M 86610	0,246	0,128
	65,088	22,225	21,463	15,875	45 000	47 500	5 600	8 000	23100	23256	0,214	0,142
	68,262	22,225	22,225	17,462	55 000	64 000	5 600	7 500	02473	02420	0,28	0,152
	72,233	25,400	25,400	19,842	63 500	83 500	5 000	7 100	HM 88630	HM 88610	0,398	0,188
72,626	24,608	24,257	17,462	60 000	58 000	5 600	7 500	41100	41286	0,32	0,177	
26,988	50,292	14,224	14,732	10,668	27 600	32 000	7 100	10 000	¹ L 44649	¹ L 44610	0,081	0,039
	57,150	19,845	19,355	15,875	40 000	44 500	6 700	9 000	1997 X	1922	0,152	0,077
	60,325	19,842	17,462	15,875	39 500	45 500	6 700	9 000	15580	15523	0,141	0,123
	62,000	19,050	20,638	14,288	46 000	53 000	6 000	8 000	15106	15245	0,211	0,081
28,575	57,150	19,845	19,355	15,875	40 000	44 500	6 700	9 000	1988	1922	0,141	0,077
	59,131	15,875	16,764	11,811	34 500	41 500	6 300	8 500	¹ LM 67043	¹ LM 67010	0,147	0,062
	62,000	19,050	20,638	14,288	46 000	53 000	6 000	8 000	15112	15245	0,199	0,081
	62,000	19,050	20,638	14,288	46 000	53 000	6 000	8 000	15113	15245	0,20	0,081
	64,292	21,433	21,433	16,670	51 000	64 500	5 600	8 000	M 86647	M 86610	0,223	0,128
	68,262	22,225	22,225	17,462	55 000	64 000	5 600	7 500	02474	02420	0,257	0,152
	72,626	24,608	24,257	17,462	60 000	58 000	5 600	7 500	41125	41286	0,292	0,177
	72,626	24,608	24,257	17,462	60 000	58 000	5 600	7 500	41126	41286	0,295	0,177
	73,025	22,225	22,225	17,462	54 500	64 500	5 300	7 100	02872	02820	0,321	0,16

¹ The tolerances for the bore diameter and overall bearing width differ from the standard (See Table 5 on Page B110 in Cat. RB/A/GB/...).

² The tolerances are listed in Tables 2, 3 and 4 on Pages B109 and B110 in Cat. RB/A/GB/...

Tapered Roller Bearings (Inch)

Bore Diameter 29,000 – 32,000 mm

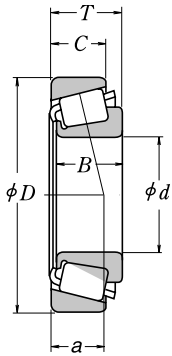

Boundary Dimensions (mm)					Basic Load Ratings (N)		Limiting Speeds (min ⁻¹)		Bearing Numbers		Mass (kg) approx	
d	D	T	B	C	C _r	C _{0r}	Grease	Oil	Cone	Cup	Cone	Cup
29,000	50,292	14,224	14,732	10,668	26 800	34 000	7 100	9 500	²⁾ L 45449	²⁾ L 45410	0,079	0,036
29,367	66,421	23,812	25,433	19,050	65 000	73 000	6 000	8 000	2690	2631	0,242	0,165
30,000	62,000	16,002	16,566	14,288	37 000	39 500	6 300	8 500	¹⁾ 17118	17244	0,136	0,091
	62,000	19,050	20,638	14,288	46 000	53 000	6 000	8 000	¹⁾ 15117	15245	0,189	0,081
	63,500	20,638	20,638	15,875	46 000	53 000	6 000	8 000	¹⁾ 15117	15250	0,189	0,113
	72,000	19,000	18,923	15,875	52 000	56 000	5 600	7 500	¹⁾ 26118	26283	0,225	0,163
30,112	62,000	19,050	20,638	14,288	46 000	53 000	6 000	8 000	15116	15245	0,189	0,081
30,162	58,738	14,684	15,080	10,716	28 800	33 500	6 000	8 000	08118	08231	0,12	0,057
	64,292	21,433	21,433	16,670	51 000	64 500	5 600	8 000	M 86649	M 86610	0,211	0,128
	68,262	22,225	22,225	17,462	55 500	70 500	5 300	7 500	M 88043	M 88010	0,263	0,146
	69,850	23,812	25,357	19,050	71 000	84 000	5 600	7 500	2558	2523	0,297	0,169
	69,850	23,812	25,357	19,050	71 000	84 000	5 600	7 500	2559	2523	0,298	0,169
76,200	24,608	24,074	16,670	67 500	69 500	5 000	6 700	43118	43300	0,383	0,146	
30,213	62,000	19,050	20,638	14,288	46 000	53 000	6 000	8 000	15118	15245	0,186	0,081
	62,000	19,050	20,638	14,288	46 000	53 000	6 000	8 000	15120	15245	0,188	0,081
	62,000	19,050	20,638	14,288	46 000	53 000	6 000	8 000	15119	15245	0,188	0,081
30,955	64,292	21,433	21,433	16,670	51 000	64 500	5 600	8 000	M 86648 A	M 86610	0,205	0,128
31,750	58,738	14,684	15,080	10,716	28 800	33 500	6 000	8 000	08125	08231	0,113	0,057
	59,131	15,875	16,764	11,811	34 500	41 500	6 300	8 500	²⁾ LM 67048	²⁾ LM 67010	0,127	0,062
	62,000	18,161	19,050	14,288	46 000	53 000	6 000	8 000	15123	15245	0,165	0,081
	62,000	19,050	20,638	14,288	46 000	53 000	6 000	8 000	15126	15245	0,176	0,081
	62,000	19,050	20,638	14,288	46 000	53 000	6 000	8 000	15125	15245	0,174	0,081
	63,500	20,638	20,638	15,875	46 000	53 000	6 000	8 000	15126	15250	0,176	0,113
	68,262	22,225	22,225	17,462	55 000	64 000	5 600	7 500	02475	02420	0,229	0,152
	68,262	22,225	22,225	17,462	55 500	70 500	5 300	7 500	M 88046	M 88010	0,25	0,146
	69,012	19,845	19,583	15,875	47 000	56 000	5 600	7 500	14125 A	14276	0,219	0,135
	69,012	26,982	26,721	15,875	47 000	56 000	5 600	7 500	14123 A	14274	0,289	0,132
	69,850	23,812	25,357	19,050	71 000	84 000	5 600	7 500	2580	2523	0,282	0,169
	69,850	23,812	25,357	19,050	71 000	84 000	5 600	7 500	2582	2523	0,28	0,169
	72,626	30,162	29,997	23,812	79 500	90 000	5 300	7 500	3188	3120	0,368	0,225
	73,025	29,370	27,783	23,020	74 000	100 000	5 000	7 100	HM 88542	HM 88510	0,379	0,242
80,000	21,000	22,403	17,826	68 500	75 500	4 500	6 300	346	332	0,419	0,146	
32,000	72,233	25,400	25,400	19,842	63 500	83 500	5 000	7 100	¹⁾ HM 88638	HM 88610	0,337	0,188

¹⁾ The maximum bore diameter is listed and its tolerance is negative (See Table 8.4.1 on Page A68 in Cat. RB/A/GB/...).

²⁾ The tolerances for the bore diameter and overall bearing width differ from the standard (See Table 5 on Page B110 in Cat. RB/A/GB/...).

Tapered Roller Bearings (Inch)

Bore Diameter 33,338 – 35,000 mm



Boundary Dimensions (mm)					Basic Load Ratings (N)		Limiting Speeds (min ⁻¹)		Bearing Numbers		Mass (kg) approx	
d	D	T	B	C	C _r	C _{0r}	Grease	Oil	Cone	Cup	Cone	Cup
33,338	66,675	20,638	20,638	15,875	46 000	53 500	5 600	7 500	1680	1620	0,196	0,121
	68,262	22,225	22,225	17,462	55 500	70 500	5 300	7 500	M 88048	M 88010	0,236	0,146
	69,012	19,845	19,583	15,875	47 000	56 000	5 600	7 500	14130	14274	0,207	0,132
	69,012	19,845	19,583	15,875	47 000	56 000	5 600	7 500	14131	14276	0,209	0,135
	69,850	23,812	25,357	19,050	71 000	84 000	5 600	7 500	2585	2523	0,263	0,169
	72,000	19,000	18,923	15,875	52 000	56 000	5 600	7 500	26131	26283	0,20	0,163
	72,626	30,162	29,997	23,812	79 500	90 000	5 300	7 500	3197	3120	0,348	0,225
	73,025	29,370	27,783	23,020	74 000	100 000	5 000	7 100	HM 88547	HM 88510	0,362	0,242
	76,200	29,370	28,575	23,020	78 500	106 000	4 800	6 700	HM 89444	HM 89411	0,419	0,261
	76,200	29,370	28,575	23,020	78 500	106 000	4 800	6 700	HM 89443	HM 89410	0,421	0,257
79,375	25,400	24,074	17,462	67 500	69 500	5 000	6 700	43131	43312	0,348	0,22	
34,925	65,088	18,034	18,288	13,970	47 500	57 500	5 600	7 500	³ LM 48548	³ LM 48510	0,172	0,087
	65,088	20,320	18,288	16,256	47 500	57 500	5 600	7 500	³ LM 48548	³ LM 48511	0,172	0,108
	66,675	20,638	20,638	16,670	53 000	62 500	5 600	7 500	M 38549	M 38510	0,194	0,112
	69,012	19,845	19,583	15,875	47 000	56 000	5 600	7 500	14138 A	14276	0,194	0,135
	69,012	19,845	19,583	15,875	47 000	56 000	5 600	7 500	14137 A	14276	0,196	0,135
	72,233	25,400	25,400	19,842	63 500	83 500	5 000	7 100	HM 88649	HM 88610	0,307	0,188
	73,025	22,225	22,225	17,462	54 500	64 500	5 300	7 100	02878	02820	0,266	0,16
	73,025	22,225	23,812	17,462	63 500	77 000	5 300	7 100	2877	2820	0,291	0,15
	73,025	23,812	24,608	19,050	71 000	86 000	5 300	7 100	25877	25821	0,306	0,167
	73,025	23,812	24,608	19,050	71 000	86 000	5 300	7 100	25878	25820	0,304	0,165
	76,200	29,370	28,575	23,020	78 500	106 000	4 800	6 700	HM 89446 A	HM 89411	0,403	0,261
	76,200	29,370	28,575	23,020	78 500	106 000	4 800	6 700	HM 89446	HM 89411	0,40	0,261
	76,200	29,370	28,575	23,020	78 500	106 000	4 800	6 700	HM 89446	HM 89410	0,40	0,257
	76,200	29,370	28,575	23,812	80 500	96 500	5 000	6 700	31594	31520	0,404	0,235
79,375	29,370	29,771	23,812	88 000	106 000	4 800	6 700	3478	3420	0,448	0,259	
34,976	68,262	15,875	16,520	11,908	45 000	53 500	5 300	7 100	19138	19268	0,196	0,073
	72,085	22,385	19,583	18,415	47 000	56 000	5 600	7 500	14139	14283	0,198	0,21
	80,000	21,006	20,940	15,875	56 500	64 500	5 000	6 700	28138	28315	0,308	0,199
35,000	59,131	15,875	16,764	11,938	35 000	47 000	6 000	8 000	⁴ L 68149	³ L 68110	0,117	0,056
	59,975	15,875	16,764	11,938	35 000	47 000	6 000	8 000	¹ L 68149	³ L 68111	0,117	0,064
	62,000	16,700	17,000	13,600	38 000	50 000	5 600	8 000	¹ LM 78349	² LM 78310	0,137	0,074
	62,000	16,700	17,000	13,600	38 000	50 000	5 600	8 000	¹ LM 78349	² LM 78310 A	0,138	0,073
	65,987	20,638	20,638	16,670	53 000	62 500	5 600	7 500	M 38547	M 38511	0,193	0,103
	73,025	26,988	26,975	22,225	75 500	88 500	5 300	7 500	23691	23621	0,309	0,212

¹ The maximum bore diameter is listed and its tolerance is negative (See Table 8.4.1 on Page A68 in Cat. RB/A/GB/...)
² The maximum outside diameter is listed and its tolerance is negative (See Table 8.4.2 on Pages A68 and A69 in Cat. RB/A/GB/...)
³ The tolerances for the bore diameter and overall bearing width differ from the standard (See Table 5 on Page B110 in Cat. RB/A/GB/...)
⁴ The tolerance for the bore diameter is 0 to 20 µm, and for overall bearing width is +356 to 0 µm.

Tapered Roller Bearings (Inch)

Bore Diameter 35,717 – 41,275 mm

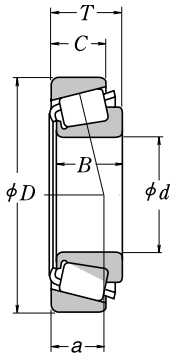

Boundary Dimensions (mm)					Basic Load Ratings (N)		Limiting Speeds (min ⁻¹)		Bearing Numbers		Mass (kg) approx	
d	D	T	B	C	C _r	C _{0r}	Grease	Oil	Cone	Cup	Cone	Cup
35,717	72,233	25,400	25,400	19,842	63 500	83 500	5 000	7 100	HM 88648	HM 88610	0,298	0,188
36,487	73,025	23,812	24,608	19,050	71 000	86 000	5 300	7 100	25880	25821	0,291	0,167
36,512	76,200	29,370	28,575	23,020	78 500	106 000	4 800	6 700	HM 89449	HM 89410	0,38	0,257
	79,375	29,370	29,771	23,812	88 000	106 000	4 800	6 700	3479	3420	0,429	0,259
	88,501	25,400	23,698	17,462	73 000	81 000	4 000	5 600	44143	44348	0,502	0,245
	93,662	31,750	31,750	26,195	110 000	142 000	4 000	5 600	46143	46368	0,765	0,405
38,000	63,000	17,000	17,000	13,500	38 500	52 000	5 600	7 500	³ JL 69349	³ JL 69310	0,132	0,071
38,100	63,500	12,700	11,908	9,525	24 100	30 500	5 300	7 100	13889	13830	0,109	0,046
	65,088	18,034	18,288	13,970	42 500	55 000	5 300	7 500	LM 29749	LM 29710	0,16	0,079
	65,088	18,034	18,288	13,970	42 500	55 000	5 300	7 500	LM 29748	LM 29710	0,158	0,079
	65,088	19,812	18,288	15,748	42 500	55 000	5 300	7 500	LM 29749	LM 29711	0,16	0,094
	68,262	15,875	16,520	11,908	45 000	53 500	5 300	7 100	19150	19268	0,173	0,073
	69,012	19,050	19,050	15,083	49 000	61 000	5 300	7 100	13687	13621	0,193	0,104
	69,012	19,050	19,050	15,083	49 000	61 000	5 300	7 100	13685	13620	0,191	0,105
	72,238	20,638	20,638	15,875	48 500	59 500	5 300	7 100	16150	16284	0,212	0,146
	73,025	23,812	25,654	19,050	73 500	91 000	5 000	6 700	2788	2735 X	0,312	0,135
	76,200	23,812	25,654	19,050	73 500	91 000	5 000	6 700	2788	2720	0,312	0,187
	76,200	23,812	25,654	19,050	73 500	91 000	5 000	6 700	2788	2729	0,312	0,191
	79,375	29,370	29,771	23,812	88 000	106 000	4 800	6 700	3490	3420	0,404	0,259
	80,035	24,608	23,698	18,512	69 000	84 500	4 500	6 300	27880	27820	0,362	0,209
	82,550	29,370	28,575	23,020	87 000	117 000	4 500	6 000	HM 801346	HM 801310	0,483	0,282
	88,501	25,400	23,698	17,462	73 000	81 000	4 000	5 600	44150	44348	0,484	0,245
88,501	26,988	29,083	22,225	96 500	109 000	4 500	6 000	418	414	0,50	0,329	
95,250	30,958	28,301	20,638	87 500	97 000	3 600	5 300	53150	53375	0,665	0,365	
39,688	73,025	25,654	22,098	21,336	62 500	80 000	5 000	6 700	M 201047	M 201011	0,266	0,169
	76,200	23,812	25,654	19,050	73 500	91 000	5 000	6 700	2789	2720	0,292	0,187
	80,167	29,370	30,391	23,812	92 500	108 000	4 800	6 300	3386	3320	0,442	0,217
40,000	80,000	21,000	22,403	17,826	68 500	75 500	4 500	6 300	344	332	0,338	0,146
	80,000	21,000	22,403	17,826	68 500	75 500	4 500	6 300	344 A	332	0,339	0,146
	88,501	25,400	23,698	17,462	73 000	81 000	4 000	5 600	44157	44348	0,463	0,245
41,000	68,000	17,500	18,000	13,500	43 500	58 000	5 300	7 100	¹ LM 300849	² LM 300811	0,16	0,082
41,275	73,025	16,667	17,462	12,700	44 500	54 000	4 800	6 700	18590	18520	0,199	0,086
	73,431	19,558	19,812	14,732	54 500	67 000	4 800	6 700	LM 501349	LM 501310	0,226	0,108
	73,431	21,430	19,812	16,604	54 500	67 000	4 800	6 700	LM 501349	LM 501314	0,226	0,129

¹⁾ The maximum bore diameter is listed and its tolerance is negative (See Table 8.4.1 on Page A68 in Cat. RB/A/GB/...).

²⁾ The maximum outside diameter is listed and its tolerance is negative (See Table 8.4.2 on Pages A68 and A69 in Cat. RB/A/GB/...).

³⁾ The tolerances are listed in Tables 2, 3 and 4 on Pages B109 and B110 in Cat. RB/A/GB/...

Tapered Roller Bearings (Inch)

Bore Diameter 41,275 – 44,450 mm



Boundary Dimensions (mm)					Basic Load Ratings (N)		Limiting Speeds (min ⁻¹)		Bearing Numbers		Mass (kg) approx	
d	D	T	B	C	C _r	C _{0r}	Grease	Oil	Cone	Cup	Cone	Cup
41,275	76,200	18,009	17,384	14,288	42 500	51 000	4 500	6 300	11162	11300	0,212	0,129
	76,200	22,225	23,020	17,462	66 000	82 000	4 800	6 700	24780	24720	0,279	0,15
	76,200	25,400	23,020	20,638	66 000	82 000	4 800	6 700	24780	24721	0,279	0,189
	79,375	23,812	25,400	19,050	77 000	98 500	4 800	6 300	26882	26822	0,349	0,186
	80,000	21,000	22,403	17,826	68 500	75 500	4 500	6 300	336	332	0,325	0,146
	80,000	21,000	22,403	17,826	68 500	75 500	4 500	6 300	342	332	0,323	0,146
	80,167	25,400	25,400	20,638	77 000	98 500	4 800	6 300	26882	26820	0,349	0,219
	82,550	26,543	25,654	20,193	78 500	102 000	4 300	6 000	M 802048	M 802011	0,406	0,23
	85,725	30,162	30,162	23,812	91 000	115 000	4 300	6 000	3877	3820	0,506	0,285
	87,312	30,162	30,886	23,812	96 000	120 000	4 300	6 000	3576	3525	0,532	0,304
	88,501	25,400	23,698	17,462	73 000	81 000	4 000	5 600	44162	44348	0,447	0,245
	88,900	30,162	29,370	23,020	96 500	129 000	4 000	5 600	HM 803146	HM 803110	0,579	0,322
	88,900	30,162	29,370	23,020	96 500	129 000	4 000	5 600	HM 803145	HM 803110	0,582	0,322
	90,488	39,688	40,386	33,338	139 000	180 000	4 300	5 600	4388	4335	0,789	0,459
	93,662	31,750	31,750	26,195	110 000	142 000	4 000	5 600	46162	46368	0,695	0,405
	95,250	30,162	29,370	23,020	106 000	143 000	3 800	5 300	HM 804840	HM 804810	0,726	0,354
98,425	30,958	28,301	20,638	87 500	97 000	3 600	5 300	53162	53387	0,618	0,442	
42,862	76,992	17,462	17,145	11,908	44 000	54 000	4 500	6 000	12168	12303	0,228	0,098
	82,550	19,842	19,837	15,080	58 500	69 000	4 500	6 300	22168	22325	0,283	0,176
	82,931	23,812	25,400	19,050	76 500	99 000	4 500	6 000	25578	25520	0,383	0,203
	82,931	26,988	25,400	22,225	76 500	99 000	4 500	6 000	25578	25523	0,383	0,248
42,875	76,200	25,400	25,400	20,638	77 000	98 500	4 800	6 300	26884	26823	0,337	0,136
	80,000	21,000	22,403	17,826	68 500	75 500	4 500	6 300	342 5	332	0,305	0,146
	82,931	26,988	25,400	22,225	76 500	99 000	4 500	6 000	25577	25523	0,381	0,248
	83,058	23,812	25,400	19,050	76 500	99 000	4 500	6 000	25577	25521	0,381	0,201
43,000	74,988	19,368	19,837	14,288	52 500	68 000	4 800	6 300	¹⁾ 16986	16929	0,24	0,106
44,450	80,962	19,050	17,462	14,288	45 000	57 000	4 300	6 000	13175	13318	0,252	0,144
	82,931	23,812	25,400	19,050	76 500	99 000	4 500	6 000	25580	25520	0,359	0,203
	83,058	23,812	25,400	19,050	76 500	99 000	4 500	6 000	25580	25521	0,359	0,201
	87,312	30,162	30,886	23,812	96 000	120 000	4 300	6 000	3578	3525	0,477	0,304
	88,900	30,162	29,370	23,020	96 500	129 000	4 000	5 600	HM 803149	HM 803110	0,528	0,322
	93,264	30,162	30,302	23,812	103 000	136 000	3 800	5 300	3782	3720	0,678	0,292
	93,662	31,750	31,750	25,400	120 000	147 000	4 000	5 600	49176	49368	0,648	0,371
	93,662	31,750	31,750	25,400	120 000	147 000	4 000	5 600	49175	49368	0,645	0,371
	93,662	31,750	31,750	26,195	110 000	142 000	4 000	5 600	46176	46368	0,635	0,405
	95,250	27,783	29,901	22,225	106 000	126 000	4 300	5 600	438	432	0,555	0,384

¹⁾ The maximum bore diameter is listed and its tolerance is negative (See Table 8.4.1 on Page A68 in Cat. RB/A/GB/...).

Tapered Roller Bearings (Inch)

Bore Diameter 44,450 – 47,625 mm

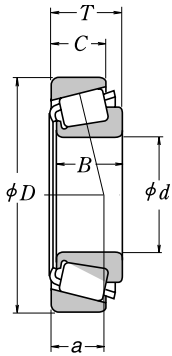

Boundary Dimensions (mm)					Basic Load Ratings (N)		Limiting Speeds (min ⁻¹)		Bearing Numbers		Mass (kg) approx	
d	D	T	B	C	C _r	C _{0r}	Grease	Oil	Cone	Cup	Cone	Cup
44,450	95,250	30,162	29,370	23,020	106 000	143 000	3 800	5 300	HM 804843	HM 804810	0,677	0,354
	95,250	30,958	28,301	20,638	87 500	97 000	3 600	5 300	53177	53375	0,572	0,365
	95,250	30,958	28,301	20,638	87 500	97 000	3 600	5 300	53176	53375	0,574	0,365
	95,250	30,958	28,301	20,638	87 500	97 000	3 600	5 300	53178	53375	0,574	0,365
	95,250	30,958	28,301	22,225	100 000	122 000	3 600	5 000	HM 903247	HM 903210	0,651	0,389
	95,250	30,958	28,575	22,225	100 000	122 000	3 600	5 000	HM 903249	HM 903210	0,635	0,389
	98,425	30,958	28,301	20,638	87 500	97 000	3 600	5 300	53177	53387	0,568	0,442
	103,188	43,658	44,475	36,512	178 000	238 000	3 800	5 000	5356	5335	1,23	0,637
	104,775	36,512	36,512	28,575	139 000	192 000	3 400	4 800	HM 807040	HM 807010	1,14	0,502
	107,950	27,783	29,317	22,225	116 000	149 000	3 400	4 800	460	453 A	0,93	0,42
	111,125	30,162	26,909	20,638	92 500	110 000	3 200	4 300	55175	55437	0,867	0,514
114,300	44,450	44,450	34,925	172 000	205 000	3 600	4 800	65385	65320	1,39	0,894	
44,983	82,931	23,812	25,400	19,050	76 500	99 000	4 500	6 000	25584	25520	0,354	0,203
45,000	93,264	20,638	22,225	15,082	77 000	93 000	3 800	5 300	376	374	0,492	0,174
45,230	79,985	19,842	20,638	15,080	62 000	78 500	4 500	6 000	17887	17831	0,274	0,136
45,242	73,431	19,558	19,812	15,748	53 500	75 000	4 800	6 300	LM 102949	LM 102910	0,213	0,102
	77,788	19,842	19,842	15,080	56 000	71 000	4 500	6 300	LM 603049	LM 603011	0,249	0,119
	77,788	21,430	19,842	16,667	56 000	71 000	4 500	6 300	LM 603049	LM 603012	0,249	0,137
45,618	82,931	23,812	25,400	19,050	76 500	99 000	4 500	6 000	25590	25520	0,343	0,203
	82,931	26,988	25,400	22,225	76 500	99 000	4 500	6 000	25590	25523	0,343	0,248
46,000	75,000	18,000	18,000	14,000	51 000	71 500	4 500	6 300	¹ LM 503349	² LM 503310	0,209	0,096
46,038	79,375	17,462	17,462	13,495	46 000	57 000	4 500	6 000	18690	18620	0,211	0,126
	80,962	19,050	17,462	14,288	45 000	57 000	4 300	6 000	13181	13318	0,236	0,144
	85,000	20,638	21,692	17,462	71 500	81 500	4 300	6 000	359 S	354 A	0,343	0,162
	85,000	25,400	25,608	20,638	79 500	105 000	4 300	6 000	2984	2924	0,397	0,223
	95,250	27,783	29,901	22,225	106 000	126 000	4 300	5 600	436	432 A	0,536	0,381
47,625	88,900	20,638	22,225	16,513	73 000	85 000	4 000	5 600	369 A	362 A	0,381	0,166
	88,900	25,400	25,400	19,050	86 000	107 000	4 000	5 600	M 804049	M 804010	0,455	0,218
	95,250	30,162	29,370	23,020	106 000	143 000	3 800	5 300	HM 804846	HM 804810	0,626	0,354
	101,600	34,925	36,068	26,988	137 000	169 000	3 800	5 000	528	522	0,894	0,416
	111,125	30,162	26,909	20,638	92 500	110 000	3 200	4 300	55187	55437	0,817	0,514
	112,712	30,162	26,909	20,638	92 500	110 000	3 200	4 300	55187	55443	0,816	0,554
	117,475	33,338	31,750	23,812	137 000	156 000	3 200	4 300	66187	66462	1,19	0,552
	123,825	36,512	32,791	25,400	143 000	160 000	3 000	4 000	72187	72487	1,29	0,79

¹⁾ The maximum bore diameter is listed and its tolerance is negative (See Table 8.4.1 on Page A68 in Cat. RB/A/GB/...).

²⁾ The maximum outside diameter is listed and its tolerance is negative (See Table 8.4.2 on Pages A68 and A69 in Cat. RB/A/GB/...).

Tapered Roller Bearings (Inch)

Bore Diameter 48,412 – 52,388 mm



Boundary Dimensions (mm)					Basic Load Ratings (N)		Limiting Speeds (min ⁻¹)		Bearing Numbers		Mass (kg) approx	
d	D	T	B	C	C _r	C _{0r}	Grease	Oil	Cone	Cup	Cone	Cup
48,412	95,250	30,162	29,370	23,020	106 000	143 000	3 800	5 300	HM 804849	HM 804810	0,61	0,354
	95,250	30,162	29,370	23,020	106 000	143 000	3 800	5 300	HM 804848	HM 804810	0,614	0,354
49,212	104,775	36,512	36,512	28,575	139 000	192 000	3 400	4 800	HM 807044	HM 807011	1,03	0,508
	114,300	44,450	44,450	36,068	196 000	243 000	3 400	4 800	HH 506348	HH 506310	1,43	0,837
50,000	82,000	21,500	21,500	17,000	71 000	96 000	4 300	5 600	² JLM 104948	² JLM 104910	0,306	0,129
	82,550	21,590	22,225	16,510	71 000	96 000	4 300	5 600	¹ LM 104947 A	LM 104911	0,316	0,133
	88,900	20,638	22,225	16,513	73 000	85 000	4 000	5 600	366	362 A	0,351	0,166
	90,000	28,000	28,000	23,000	104 000	136 000	4 000	5 600	² JM 205149	² JM 205110	0,507	0,246
	105,000	37,000	36,000	29,000	139 000	192 000	3 400	4 800	² JHM 807045	² JHM 807012	1,01	0,523
50,800	80,962	18,258	18,258	14,288	53 000	81 000	4 300	5 600	L 305649	L 305610	0,239	0,119
	82,550	23,622	22,225	18,542	71 000	96 000	4 300	5 600	LM 104949	LM 104911 A	0,303	0,156
	82,931	21,590	22,225	16,510	71 000	96 000	4 300	5 600	LM 104949	LM 104912	0,301	0,14
	85,000	17,462	17,462	13,495	48 500	63 000	4 300	5 600	18790	18720	0,239	0,136
	85,725	19,050	18,263	12,700	42 500	54 000	4 000	5 300	18200	18337	0,268	0,136
	88,900	20,638	22,225	16,513	73 000	85 000	4 000	5 600	368 A	362 A	0,338	0,166
	88,900	20,638	22,225	16,513	73 000	85 000	4 000	5 600	368	362 A	0,341	0,166
	92,075	24,608	25,400	19,845	84 500	117 000	4 000	5 300	28580	28521	0,46	0,247
	93,264	30,162	30,302	23,812	103 000	136 000	3 800	5 300	3775	3730	0,568	0,297
	93,264	30,162	30,302	23,812	103 000	136 000	3 800	5 300	3780	3730	0,564	0,297
	95,250	27,783	28,575	22,225	110 000	144 000	3 800	5 300	33889	33821	0,601	0,267
	101,600	31,750	31,750	25,400	118 000	150 000	3 600	5 000	49585	49520	0,744	0,389
	101,600	34,925	36,068	26,988	137 000	169 000	3 800	5 000	529	522	0,822	0,416
	101,600	34,925	36,068	26,988	137 000	169 000	3 800	5 000	529 X	522	0,819	0,416
	104,775	36,512	36,512	28,575	139 000	192 000	3 400	4 800	HM 807046	HM 807011	0,992	0,508
	104,775	36,512	36,512	28,575	139 000	192 000	3 400	4 800	HM 807046	HM 807010	0,993	0,502
	108,966	34,925	36,512	26,988	145 000	181 000	3 600	4 800	59200	59429	0,943	0,594
	111,125	30,162	26,909	20,638	113 000	152 000	3 000	4 300	55200 C	55437	0,845	0,514
	111,125	30,162	26,909	20,638	92 500	110 000	3 200	4 300	55200	55437	0,767	0,514
	123,825	36,512	32,791	25,400	162 000	199 000	2 800	4 000	72200 C	72487	1,33	0,79
123,825	36,512	32,791	25,400	143 000	160 000	3 000	4 000	72200	72487	1,22	0,79	
127,000	44,450	44,450	34,925	199 000	258 000	3 000	4 000	65200	65500	1,86	1,03	
127,000	50,800	52,388	41,275	236 000	300 000	3 200	4 300	6279	6220	2,08	1,22	
52,388	92,075	24,608	25,400	19,845	84 500	117 000	4 000	5 300	28584	28521	0,435	0,247
	100,000	25,000	22,225	21,824	77 000	93 000	3 800	5 300	377	372	0,392	0,435
	111,125	30,162	26,909	20,638	92 500	110 000	3 200	4 300	55206	55437	0,737	0,514

¹ The tolerances for the bore diameter and overall bearing width differ from the standard (See Table 5 on Page B110 in Cat. RB/A/GB/...).

² The tolerances are listed in Tables 2, 3 and 4 on Pages B109 and B110 in Cat. RB/A/GB/...

Tapered Roller Bearings (Inch)

Bore Diameter 53,975 – 58,738 mm

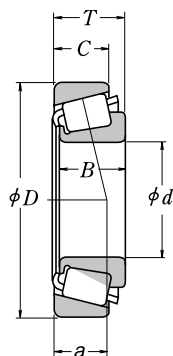

Boundary Dimensions (mm)					Basic Load Ratings (N)		Limiting Speeds (min ⁻¹)		Bearing Numbers		Mass (kg) approx		
d	D	T	B	C	C _r	C _{0r}	Grease	Oil	Cone	Cup	Cone	Cup	
53,975	104,775	39,688	40,157	33,338	150 000	210 000	3 600	4 800	4595	4535	0,972	0,583	
	107,950	36,512	36,957	28,575	144 000	182 000	3 600	4 800	539	532 X	0,88	0,57	
	122,238	33,338	31,750	23,812	135 000	156 000	3 000	4 000	66584	66520	1,2	0,558	
	123,825	36,512	32,791	25,400	143 000	160 000	3 000	4 000	72212	72487	1,16	0,79	
	123,825	36,512	32,791	25,400	162 000	199 000	2 800	4 000	72212 C	72487	1,27	0,79	
	123,825	38,100	36,678	30,162	161 000	221 000	3 000	4 000	557 S	552 A	1,49	0,764	
	127,000	44,450	44,450	34,925	199 000	258 000	3 000	4 000	65212	65500	1,76	1,03	
	127,000	50,800	52,388	41,275	236 000	300 000	3 200	4 300	6280	6220	1,97	1,22	
	130,175	36,512	33,338	23,812	133 000	154 000	2 600	3 600	HM911242	HM911210	1,45	0,725	
55,000	90,000	23,000	23,000	18,500	79 000	111 000	3 800	5 300	¹⁾ JLM506849	¹⁾ JLM506810	0,378	0,186	
	95,000	29,000	29,000	23,500	111 000	152 000	3 800	5 000	¹⁾ JM207049	¹⁾ JM207010	0,59	0,26	
	96,838	21,000	21,946	15,875	80 500	100 000	3 600	5 000	385	382 A	0,455	0,179	
	110,000	39,000	39,000	32,000	177 000	225 000	3 400	4 500	¹⁾ JH307749	¹⁾ JH307710	1,13	0,567	
	115,000	41,021	41,275	31,496	172 000	214 000	3 200	4 500	622 X	614 X	1,3	0,597	
55,562	97,630	24,608	24,608	19,446	89 000	129 000	3 600	5 000	28680	28622	0,499	0,27	
	122,238	43,658	43,764	36,512	198 000	292 000	3 000	4 000	5566	5535	1,76	0,815	
	123,825	36,512	32,791	25,400	143 000	160 000	3 000	4 000	72218	72487	1,12	0,79	
	123,825	36,512	32,791	25,400	162 000	199 000	2 800	4 000	72218 C	72487	1,23	0,79	
57,150	96,838	21,000	21,946	15,875	80 500	100 000	3 600	5 000	387 A	382 A	0,42	0,179	
	96,838	21,000	21,946	15,875	80 500	100 000	3 600	5 000	387	382 A	0,423	0,179	
	96,838	25,400	21,946	20,275	80 500	100 000	3 600	5 000	387 A	382 S	0,42	0,249	
	98,425	21,000	21,946	17,826	80 500	100 000	3 600	5 000	387 A	382	0,42	0,226	
	104,775	30,162	29,317	24,605	116 000	149 000	3 400	4 800	469	453 X	0,692	0,376	
	104,775	30,162	29,317	24,605	116 000	149 000	3 400	4 800	462	453 X	0,694	0,376	
	104,775	30,162	30,958	23,812	130 000	170 000	3 400	4 800	45289	45220	0,752	0,347	
	104,775	30,162	30,958	23,812	130 000	170 000	3 400	4 800	45289	45221	0,76	0,35	
	122,238	33,338	31,750	23,812	135 000	156 000	3 000	4 000	66587	66520	1,14	0,558	
	123,825	36,512	32,791	25,400	162 000	199 000	2 800	4 000	72225 C	72487	1,19	0,79	
	123,825	38,100	36,678	30,162	161 000	221 000	3 000	4 000	555 S	552 A	1,41	0,764	
	140,030	36,512	33,236	23,520	152 000	183 000	2 600	3 600	78225	78551	1,67	0,926	
	144,983	36,000	33,236	23,007	152 000	183 000	2 600	3 600	78225	78571	1,68	1,08	
	149,225	53,975	54,229	44,450	287 000	410 000	2 600	3 400	6455	6420	3,49	1,63	
	57,531	96,838	21,000	21,946	15,875	80 500	100 000	3 600	5 000	388 A	382 A	0,416	0,179
	58,738	112,712	33,338	30,048	26,988	120 000	173 000	3 200	4 300	3981	3926	0,899	0,541

¹⁾ The tolerances are listed in Tables 2, 3 and 4 on Pages B109 and B110 in Cat. RB/A/GB/...

Tapered Roller Bearings (Inch)

Bore Diameter 60,000 – 64,963 mm



Boundary Dimensions (mm)					Basic Load Ratings (N)		Limiting Speeds (min ⁻¹)		Bearing Numbers		Mass (kg) approx	
d	D	T	B	C	C _r	C _{0r}	Grease	Oil	Cone	Cup	Cone	Cup
60,000	95,000	24,000	24,000	19,000	86 500	125 000	3 600	5 000	² JLM 508748	² JLM 508710	0,43	0,20
	104,775	21,433	22,000	15,875	83 500	107 000	3 400	4 500	¹ 39236	39412	0,559	0,186
	110,000	22,000	21,996	18,824	85 500	113 000	3 200	4 300	397	394 A	0,642	0,263
	122,238	33,338	31,750	23,812	135 000	156 000	3 000	4 000	66585	66520	1,07	0,558
60,325	100,000	25,400	25,400	19,845	91 000	135 000	3 400	4 800	28985	28921	0,538	0,232
	101,600	25,400	25,400	19,845	91 000	135 000	3 400	4 800	28985	28920	0,538	0,272
	122,238	38,100	36,678	30,162	161 000	221 000	3 000	4 000	558	553 X	1,33	0,692
	122,238	38,100	38,354	29,718	188 000	245 000	3 000	4 000	HM 212044	HM 212010	1,43	0,604
	122,238	43,658	43,764	36,512	198 000	292 000	3 000	4 000	5582	5535	1,61	0,815
	127,000	44,450	44,450	34,925	199 000	258 000	3 000	4 000	65237	65500	1,56	1,03
	130,175	41,275	41,275	31,750	195 000	263 000	2 800	3 800	637	633	1,87	0,712
	135,755	53,975	56,007	44,450	264 000	355 000	2 800	3 800	6376	6320	2,45	1,39
61,912	136,525	46,038	46,038	36,512	233 000	370 000	2 600	3 400	H 715334	H 715311	2,51	0,961
	146,050	41,275	39,688	25,400	193 000	225 000	2 400	3 400	H 913842	H 913810	2,2	0,898
	152,400	47,625	46,038	31,750	237 000	267 000	2 400	3 400	9180	9121	2,77	1,21
63,500	94,458	19,050	19,050	15,083	59 000	100 000	3 600	4 800	L 610549	L 610510	0,306	0,154
	104,775	21,433	22,000	15,875	83 500	107 000	3 400	4 500	39250	39412	0,501	0,186
	107,950	25,400	25,400	19,050	90 000	138 000	3 200	4 300	29586	29520	0,661	0,281
	110,000	22,000	21,996	18,824	85 500	113 000	3 200	4 300	395	394 A	0,58	0,263
	110,000	22,000	21,996	18,824	85 500	113 000	3 200	4 300	390 A	394 A	0,583	0,263
	112,712	30,162	30,048	23,812	120 000	173 000	3 200	4 300	3982	3920	0,789	0,454
	112,712	30,162	30,162	23,812	142 000	202 000	3 200	4 300	39585	39520	0,899	0,359
	112,712	33,338	30,048	26,988	120 000	173 000	3 200	4 300	3982	3926	0,789	0,541
	122,238	38,100	38,354	29,718	188 000	245 000	3 000	4 000	HM 212047	HM 212011	1,34	0,598
	122,238	38,100	38,354	29,718	188 000	245 000	3 000	4 000	HM 212047	HM 212010	1,34	0,604
	122,238	38,100	38,354	29,718	188 000	245 000	3 000	4 000	HM 212046	HM 212010	1,35	0,604
	122,238	43,658	43,764	36,512	198 000	292 000	3 000	4 000	5584	5535	1,5	0,815
	123,825	38,100	36,678	30,162	161 000	221 000	3 000	4 000	559	522 A	1,23	0,764
	127,000	36,512	36,170	28,575	166 000	234 000	2 800	3 800	565	563	1,46	0,655
	130,175	41,275	41,275	31,750	195 000	263 000	2 800	3 800	639	633	1,77	0,712
	136,525	36,512	33,236	23,520	152 000	183 000	2 600	3 600	78250	78537	1,51	0,782
	136,525	41,275	41,275	31,750	195 000	263 000	2 800	3 800	639	632	1,77	1,04
140,030	36,512	33,236	23,520	152 000	183 000	2 600	3 600	78250	78551	1,51	0,926	
64,963	127,000	36,512	36,170	28,575	166 000	234 000	2 800	3 800	569	563	1,41	0,655

¹⁾ The maximum bore diameter is listed and its tolerance is negative (See Table 8.4.1 on Page A68 in Cat. RB/A/GB/...).

²⁾ The tolerances are listed in Tables 2, 3 and 4 on Pages B109 and B110 in Cat. RB/A/GB/...

Tapered Roller Bearings (Inch)

Bore Diameter 65,000 – 69,850 mm

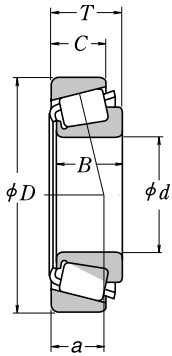

Boundary Dimensions (mm)					Basic Load Ratings (N)		Limiting Speeds (min ⁻¹)		Bearing Numbers		Mass (kg) approx	
d	D	T	B	C	C _r	C _{0r}	Grease	Oil	Cone	Cup	Cone	Cup
65,000	105,000	24,000	23,000	18,500	93 000	126 000	3 400	4 500	¹⁾ JLM 710949	¹⁾ JLM 710910	0,526	0,237
	110,000	28,000	28,000	22,500	120 000	173 000	3 200	4 300	¹⁾ JM 511946 JM	511910	0,72	0,342
	120,000	29,002	29,007	23,444	123 000	169 000	3 000	4 000	478	472 A	0,942	0,466
	120,000	39,000	38,500	32,000	185 000	249 000	3 000	4 000	¹⁾ JH 211749	¹⁾ JH 211710	1,25	0,625
65,088	135,755	53,975	56,007	44,450	264 000	355 000	2 800	3 800	6379	6320	2,25	1,39
	136,525	46,038	46,038	36,512	233 000	370 000	2 600	3 400	H 715340	H 715311	2,4	0,961
66,675	110,000	22,000	21,996	18,824	85 500	113 000	3 200	4 300	395 A	394 A	0,528	0,263
	110,000	22,000	21,996	18,824	85 500	113 000	3 200	4 300	395 S	394 A	0,524	0,263
	112,712	30,162	30,048	23,812	120 000	173 000	3 200	4 300	3984	3920	0,712	0,454
	112,712	30,162	30,048	23,812	120 000	173 000	3 200	4 300	3994	3920	0,706	0,454
	112,712	30,162	30,162	23,812	142 000	202 000	3 200	4 300	39590	39521	0,822	0,365
	112,712	30,162	30,162	23,812	142 000	202 000	3 200	4 300	39590	39520	0,822	0,359
	117,475	30,162	30,162	23,812	119 000	179 000	3 000	4 000	33262	33462	0,911	0,442
	122,238	38,100	36,678	30,162	161 000	221 000	3 000	4 000	560	553 X	1,14	0,692
	122,238	38,100	38,354	29,718	188 000	245 000	3 000	4 000	HM 212049	HM212010	1,25	0,604
	122,238	38,100	38,354	29,718	188 000	245 000	3 000	4 000	HM 212049	HM 212011	1,25	0,598
	123,825	38,100	36,678	30,162	161 000	221 000	3 000	4 000	560	552 A	1,14	0,764
	136,525	46,038	46,038	36,512	233 000	370 000	2 600	3 400	H 715341	H 715311	2,34	0,961
68,262	110,000	22,000	21,996	18,824	85 500	113 000	3 200	4 300	399 A	394 A	0,497	0,263
	120,000	29,795	29,007	24,237	123 000	169 000	3 000	4 000	480	472	0,862	0,493
	122,238	38,100	36,678	30,162	161 000	221 000	3 000	4 000	560 S	553 X	1,09	0,692
	127,000	36,512	36,170	28,575	166 000	234 000	2 800	3 800	570	563	1,32	0,655
	136,525	41,275	41,275	31,750	229 000	297 000	2 600	3 600	H 414245	H 414210	1,95	0,796
	136,525	46,038	46,038	36,512	233 000	370 000	2 600	3 400	H 715343	H 715311	2,28	0,961
	152,400	47,625	46,038	31,750	237 000	267 000	2 400	3 400	9185	9121	2,53	1,21
69,850	112,712	22,225	21,996	15,875	85 000	113 000	3 000	4 000	LM 613449	LM 613410	0,562	0,238
	112,712	25,400	25,400	19,050	96 000	152 000	2 800	4 000	29675	29620	0,695	0,273
	117,475	30,162	30,162	23,812	119 000	179 000	3 000	4 000	33275	33462	0,83	0,442
	120,000	32,545	32,545	26,195	152 000	225 000	3 000	4 000	47487	47420	1,02	0,477
	120,650	25,400	25,400	19,050	96 000	152 000	2 800	4 000	29675	29630	0,695	0,489
	127,000	36,512	36,170	28,575	166 000	234 000	2 800	3 800	566	563 X	1,27	0,658
	130,175	41,275	41,275	31,750	195 000	263 000	2 800	3 800	643	633	1,56	0,712
	146,050	41,275	39,688	25,400	193 000	225 000	2 400	3 400	H 913849	H 913810	1,95	0,898
	146,050	41,275	41,275	31,750	207 000	296 000	2 400	3 200	655	653	2,35	0,891
	149,225	53,975	54,229	44,450	287 000	410 000	2 600	3 400	6454	6420	2,95	1,63
	150,089	44,450	46,672	36,512	265 000	370 000	2 400	3 200	745 A	742	2,82	1,07

¹⁾ The tolerances are listed in Tables 2, 3 and 4 on Pages B109 and B110 in Cat. RB/A/GB/...

Tapered Roller Bearings (Inch)

Bore Diameter 70,000 – 76,200 mm



Boundary Dimensions (mm)					Basic Load Ratings (N)		Limiting Speeds (min ⁻¹)		Bearing Numbers		Mass (kg) approx	
d	D	T	B	C	C _r	C _{0r}	Grease	Oil	Cone	Cup	Cone	Cup
70,000	110,000	26,000	25,000	20,500	98 500	152 000	3 000	4 000	¹⁾ JLM 813049	¹⁾ JLM 813010	0,604	0,304
	115,000	29,000	29,000	23,000	126 000	177 000	3 000	4 000	¹⁾ JM 612949	¹⁾ JM 612910	0,800	0,362
	120,000	29,795	29,007	24,237	123 000	169 000	3 000	4 000	484	472	0,822	0,493
71,438	117,475	30,162	30,162	23,812	119 000	179 000	3 000	4 000	33281	33462	0,789	0,442
	120,000	32,545	32,545	26,195	152 000	225 000	3 000	4 000	47490	47420	0,983	0,477
	127,000	36,512	36,170	28,575	166 000	234 000	2 800	3 800	567 S	563	1,21	0,655
	127,000	36,512	36,170	28,575	166 000	234 000	2 800	3 800	567 A	563	1,23	0,655
	130,175	41,275	41,275	31,750	195 000	263 000	2 800	3 800	645	633	1,49	0,712
	136,525	41,275	41,275	31,750	195 000	263 000	2 800	3 800	644	632	1,5	1,04
	136,525	41,275	41,275	31,750	229 000	297 000	2 600	3 600	H 414249	H 414210	1,83	0,796
	136,525	46,038	46,038	36,512	233 000	370 000	2 600	3 400	H 715345	H 715311	2,15	0,961
73,025	112,712	25,400	25,400	19,050	96 000	152 000	2 800	4 000	29685	29620	0,62	0,273
	117,475	30,162	30,162	23,812	119 000	179 000	3 000	4 000	33287	33462	0,746	0,442
	127,000	36,512	36,170	28,575	166 000	234 000	2 800	3 800	567	563	1,17	0,655
	146,050	41,275	41,275	31,750	207 000	296 000	2 400	3 200	657	653	2,24	0,891
	149,225	53,975	54,229	44,450	287 000	410 000	2 600	3 400	6460	6420	2,8	1,63
73,817	127,000	36,512	36,170	28,575	166 000	234 000	2 800	3 800	568	563	1,15	0,655
74,612	150,000	41,275	41,275	31,750	207 000	296 000	2 400	3 200	658	653 X	2,37	0,932
75,000	115,000	25,000	25,000	19,000	101 000	150 000	3 000	4 000	¹⁾ JLM 714149	¹⁾ JLM 714110	0,638	0,272
	120,000	31,000	29,500	25,000	129 000	198 000	2 800	3 800	¹⁾ JM 714249	¹⁾ JM 714210	0,863	0,436
	145,000	51,000	51,000	42,000	287 000	410 000	2 600	3 400	¹⁾ JH 415647	¹⁾ JH 415610	2,64	1,19
76,200	121,442	24,608	23,012	17,462	89 000	124 000	2 800	3 800	34300	34478	0,65	0,316
	127,000	30,162	31,000	22,225	134 000	195 000	2 800	3 800	42687	42620	1,03	0,438
	127,000	30,162	31,001	22,225	134 000	195 000	2 800	3 800	42688	42620	1,01	0,438
	133,350	33,338	33,338	26,195	154 000	237 000	2 600	3 600	47680	47620	1,39	0,577
	135,732	44,450	46,101	34,925	216 000	340 000	2 600	3 600	5760	5735	1,86	0,887
	136,525	30,162	29,769	22,225	130 000	192 000	2 600	3 400	495 A	493	1,27	0,55
	136,525	30,162	29,769	22,225	130 000	192 000	2 600	3 400	495AX	493	1,26	0,55
	139,992	36,512	36,098	28,575	175 000	260 000	2 600	3 400	575	572	1,61	0,788
	149,225	53,975	54,229	44,450	287 000	410 000	2 600	3 400	6461	6420	2,64	1,63
	152,400	39,688	36,322	30,162	183 000	285 000	2 200	3 200	590 A	592 A	2,2	1,06
	152,400	41,275	41,275	31,750	207 000	296 000	2 400	3 200	659	652	2,11	1,26
	161,925	49,212	46,038	31,750	248 000	290 000	2 200	3 000	9285	9220	2,82	1,4
	161,925	53,975	55,100	42,862	325 000	480 000	2 200	3 000	6576	6535	3,74	1,67
	161,925	53,975	55,100	42,862	325 000	480 000	2 200	3 000	6575	6535	3,73	1,67
	161,925	53,975	55,100	42,862	325 000	480 000	2 200	3 000	6575	6536	3,73	1,68

¹⁾ The tolerances are listed in Tables 2, 3 and 4 on Pages B109 and B110 in Cat. RB/A/GB/...

Tapered Roller Bearings (Inch)

Bore Diameter 76,200 – 83,345 mm

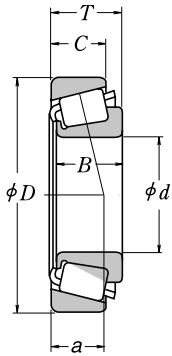

Boundary Dimensions (mm)					Basic Load Ratings (N)		Limiting Speeds (min ⁻¹)		Bearing Numbers		Mass (kg) approx	
d	D	T	B	C	C _r	C _{0r}	Grease	Oil	Cone	Cup	Cone	Cup
76,200	168,275	53,975	56,363	41,275	345 000	470 000	2 200	3 000	843	832	4,11	1,74
	168,275	53,975	56,363	41,275	345 000	470 000	2 200	3 000	837	832	4,13	1,74
	171,450	49,212	46,038	31,750	257 000	310 000	2 000	2 800	9380	9321	3,47	1,51
	177,800	55,562	50,800	34,925	257 000	310 000	2 000	2 800	9378	9320	3,71	2,24
77,788	121,442	24,608	23,012	17,462	89 000	124 000	2 800	3 800	34306	34478	0,612	0,316
	127,000	30,162	31,000	22,225	134 000	195 000	2 800	3 800	42690	42620	0,976	0,438
	135,733	44,450	46,101	34,925	216 000	340 000	2 600	3 600	5795	5735	1,79	0,887
79,375	146,050	41,275	41,275	31,750	207 000	296 000	2 400	3 200	661	653	1,99	0,891
	150,089	44,450	46,672	36,512	265 000	370 000	2 400	3 200	750	742	2,42	1,07
80,000	130,000	35,000	34,000	28,500	166 000	251 000	2 600	3 600	¹⁾ JM 515649	¹⁾ JM 515610	1,18	0,583
80,962	136,525	30,162	29,769	22,225	130 000	192 000	2 600	3 400	496	493	1,13	0,55
	139,700	36,512	36,098	28,575	175 000	260 000	2 600	3 400	581	572 X	1,44	0,774
	139,992	36,512	36,098	28,575	175 000	260 000	2 600	3 400	581	572	1,44	0,788
82,550	125,412	25,400	25,400	19,845	102 000	164 000	2 600	3 600	27687	27620	0,747	0,348
	133,350	30,162	29,769	22,225	130 000	192 000	2 600	3 400	495	492 A	1,08	0,434
	133,350	33,338	33,338	26,195	154 000	237 000	2 600	3 600	47686	47620	1,18	0,577
	133,350	33,338	33,338	26,195	154 000	237 000	2 600	3 600	47685	47620	1,18	0,577
	133,350	33,338	33,338	26,195	154 000	237 000	2 600	3 600	47687	47620	1,16	0,577
	133,350	39,688	39,688	32,545	179 000	310 000	2 600	3 600	HM 516448	HM 516410	1,35	0,767
	136,525	30,162	29,769	22,225	130 000	192 000	2 600	3 400	495	493	1,08	0,55
	139,700	36,512	36,098	28,575	175 000	260 000	2 600	3 400	580	572 X	1,39	0,774
	139,992	36,512	36,098	28,575	175 000	260 000	2 600	3 400	580	572	1,39	0,788
	139,992	36,512	36,098	28,575	175 000	260 000	2 600	3 400	582	572	1,37	0,788
	146,050	41,275	41,275	31,750	207 000	296 000	2 400	3 200	663	653	1,85	0,891
	150,000	44,455	46,672	35,000	265 000	370 000	2 400	3 200	749 A	743	2,26	1,04
	150,089	44,450	46,672	36,512	265 000	370 000	2 400	3 200	749 A	742	2,26	1,07
	152,400	41,275	41,275	31,750	207 000	296 000	2 400	3 200	663	652	1,85	1,26
	161,925	47,625	48,260	38,100	274 000	390 000	2 200	3 000	757	752	2,79	1,61
	161,925	53,975	55,100	42,862	325 000	480 000	2 200	3 000	6559	6535	3,4	1,67
	168,275	47,625	48,260	38,100	274 000	390 000	2 200	3 000	757	753	2,79	2,1
	168,275	53,975	56,363	41,275	345 000	470 000	2 200	3 000	842	832	3,76	1,74
	83,345	125,412	25,400	25,400	19,845	102 000	164 000	2 600	3 600	27690	27620	0,727
125,412		25,400	25,400	19,845	102 000	164 000	2 600	3 600	27689	27620	0,732	0,348

¹⁾ The tolerances are listed in Tables 2, 3 and 4 on Pages B109 and B110 in Cat. RB/A/GB/...

Tapered Roller Bearings (Inch)

Bore Diameter 84,138 – 90,488 mm



Boundary Dimensions (mm)					Basic Load Ratings (N)		Limiting Speeds (min ⁻¹)		Bearing Numbers		Mass (kg) approx	
d	D	T	B	C	C _r	C _{0r}	Grease	Oil	Cone	Cup	Cone	Cup
84,138	136,525	30,162	29,769	22,225	130 000	192 000	2 600	3 400	498	493	1,04	0,55
	146,050	41,275	41,275	31,750	207 000	296 000	2 400	3 200	664	653	1,79	0,891
	171,450	49,212	46,038	31,750	257 000	310 000	2 000	2 800	9385	9321	3,11	1,51
85,000	130,000	30,000	29,000	24,000	138 000	222 000	2 600	3 600	³ JM 716648	³ JM 716610	0,931	0,461
	130,000	30,000	29,000	24,000	138 000	222 000	2 600	3 600	³ JM 716649	³ JM 716610	0,943	0,461
	140,000	39,000	38,000	31,500	202 000	305 000	2 400	3 400	³ JHM 516849	³ JHM 516810	1,55	0,768
	150,000	46,000	46,000	38,000	275 000	390 000	2 400	3 200	³ JH 217249	³ JH 217210	2,29	1,09
85,026	150,089	44,450	46,672	36,512	265 000	370 000	2 400	3 200	749	742	2,14	1,07
	150,089	44,450	46,672	36,512	265 000	370 000	2 400	3 200	749 S	742	2,14	1,07
85,725	133,350	30,162	29,769	22,225	130 000	192 000	2 600	3 400	497	492 A	0,987	0,434
	136,525	30,162	29,769	22,225	130 000	192 000	2 600	3 400	497	493	0,987	0,55
	142,138	42,862	42,862	34,133	221 000	360 000	2 400	3 400	HM 617049	HM 617010	1,77	0,911
	146,050	41,275	41,275	31,750	207 000	296 000	2 400	3 200	665 A	653	1,71	0,891
	146,050	41,275	41,275	31,750	207 000	296 000	2 400	3 200	665	653	1,72	0,891
	152,400	39,688	36,322	30,162	183 000	285 000	2 200	3 200	596	592 A	1,85	1,06
	161,925	47,625	48,260	38,100	274 000	390 000	2 200	3 000	758	752	2,63	1,61
	168,275	41,275	41,275	30,162	223 000	345 000	2 000	2 800	677	672	2,91	1,24
	87,312	190,500	57,150	57,531	46,038	390 000	520 000	1 900	2 600	HH 221432	HH 221410	5,51
88,900	149,225	31,750	28,971	24,608	140 000	218 000	2 200	3 000	42350	42587	1,39	0,711
	152,400	39,688	36,322	30,162	183 000	285 000	2 200	3 200	593	592 A	1,73	1,06
	152,400	39,688	39,688	30,162	253 000	365 000	2 200	3 200	HM 518445	HM 518410	2,11	0,776
	161,925	47,625	48,260	38,100	274 000	390 000	2 200	3 000	759	752	2,47	1,61
	161,925	47,625	48,260	38,100	274 000	390 000	2 200	3 000	766	752	2,45	1,61
	161,925	53,975	55,100	42,862	325 000	480 000	2 200	3 000	6580	6535	3,03	1,67
	168,275	47,625	48,260	38,100	274 000	390 000	2 200	3 000	759	753	2,47	2,1
	168,275	53,975	56,363	41,275	345 000	470 000	2 200	3 000	850	832	3,39	1,74
	190,500	57,150	57,531	44,450	355 000	500 000	1 900	2 600	855	854	4,99	2,55
	190,500	57,150	57,531	46,038	390 000	520 000	1 900	2 600	HH 221434	HH 221410	5,41	2,24
90,000	145,000	35,000	34,000	27,000	190 000	285 000	2 400	3 200	³ JM 718149	³ JM 718110	1,49	0,66
	147,000	40,000	40,000	32,500	229 000	345 000	2 400	3 200	¹ HM 218248	² HM 218210	1,77	0,796
	155,000	44,000	44,000	35,500	274 000	395 000	2 200	3 000	³ JHM 318448	³ JHM 318410	2,32	1,01
90,488	161,925	47,625	48,260	38,100	274 000	390 000	2 200	3 000	760	752	2,38	1,61

¹⁾ The maximum bore diameter is listed and its tolerance is negative (See Table 8.4.1 on Page A68 in Cat. RB/A/GB/...).

²⁾ The maximum outside diameter is listed and its tolerance is negative (See Table 8.4.2 on Pages A68 and A69 in Cat. RB/A/GB/...).

³⁾ The tolerances are listed in Tables 2, 3 and 4 on Pages B109 and B110 in Cat. RB/A/GB/...

Tapered Roller Bearings (Inch)

Bore Diameter 92,075 – 100,012 mm

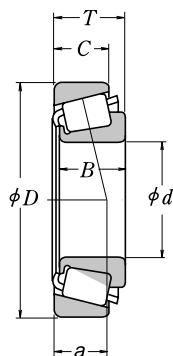

Boundary Dimensions (mm)					Basic Load Ratings (N)		Limiting Speeds (min ⁻¹)		Bearing Numbers		Mass (kg) approx	
d	D	T	B	C	C _r	C _{0r}	Grease	Oil	Cone	Cup	Cone	Cup
92,075	146,050	33,338	34,925	26,195	169 000	280 000	2 400	3 200	47890	47820	1,46	0,664
	148,430	28,575	28,971	21,433	140 000	218 000	2 200	3 000	42362	42584	1,29	0,553
	152,400	39,688	36,322	30,162	183 000	285 000	2 200	3 200	598	592 A	1,6	1,06
	152,400	39,688	36,322	30,162	183 000	285 000	2 200	3 200	598 A	592 A	1,59	1,06
	168,275	41,275	41,275	30,162	223 000	345 000	2 000	2 800	681	672	2,62	1,24
190,500	57,150	57,531	44,450	355 000	500 000	1 900	2 600	857	854	4,78	2,55	
93,662	148,430	28,575	28,971	21,433	140 000	218 000	2 200	3 000	42368	42584	1,24	0,553
	149,225	31,750	28,971	24,608	140 000	218 000	2 200	3 000	42368	42587	1,24	0,711
	152,400	39,688	36,322	30,162	183 000	285 000	2 200	3 200	597	592 A	1,54	1,06
95,000	150,000	35,000	34,000	27,000	183 000	285 000	2 200	3 200	¹⁾ JM 719149	¹⁾ JM 719113	1,46	0,765
95,250	146,050	33,338	34,925	26,195	169 000	280 000	2 400	3 200	47896	47820	1,33	0,664
	148,430	28,575	28,971	21,433	140 000	218 000	2 200	3 000	42375	42584	1,18	0,553
	149,225	31,750	28,971	24,608	140 000	218 000	2 200	3 000	42376	42587	1,18	0,711
	152,400	39,688	36,322	30,162	183 000	285 000	2 200	3 200	594	592 A	1,47	1,06
	152,400	39,688	36,322	33,338	183 000	285 000	2 200	3 200	594	592	1,47	1,12
	168,275	41,275	41,275	30,162	223 000	345 000	2 000	2 800	683	672	2,47	1,24
	171,450	47,625	48,260	38,100	282 000	415 000	2 000	2 800	77375	77675	2,91	1,67
	180,975	47,625	48,006	38,100	258 000	375 000	2 000	2 600	776	772	3,25	1,99
	190,500	57,150	57,531	44,450	355 000	500 000	1 900	2 600	864	854	4,57	2,55
190,500	57,150	57,531	46,038	390 000	520 000	1 900	2 600	HH 221440	HH 221410	5,0	2,24	
96,838	148,430	28,575	28,971	21,433	140 000	218 000	2 200	3 000	42381	42584	1,13	0,553
	149,225	31,750	28,971	24,606	140 000	218 000	2 200	3 000	42381	42587	1,13	0,711
98,425	161,925	36,512	36,116	26,195	191 000	310 000	2 000	2 800	52387	52637	1,89	0,942
	168,275	41,275	41,275	30,162	223 000	345 000	2 000	2 800	685	672	2,32	1,24
	180,975	47,625	48,006	38,100	258 000	375 000	2 000	2 600	779	772	3,06	1,99
	190,500	57,150	57,531	44,450	355 000	500 000	1 900	2 600	866	854	4,38	2,55
	190,500	57,150	57,531	46,038	390 000	520 000	1 900	2 600	HH 221442	HH 221410	4,81	2,24
99,982	190,500	57,150	57,531	46,038	390 000	520 000	1 900	2 600	HH 221447	HH 221410	4,68	2,24
100,000	150,000	32,000	30,000	26,000	146 000	235 000	2 200	3 000	¹⁾ JLM 820048	¹⁾ JLM 820012	1,27	0,616
	155,000	36,000	35,000	28,000	191 000	325 000	2 000	2 800	¹⁾ JM 720249	¹⁾ JM 720210	1,68	0,772
	160,000	41,000	40,000	32,000	239 000	380 000	2 000	2 800	¹⁾ JHM 720249	¹⁾ JHM 720210	2,09	0,974
100,012	157,162	36,512	36,116	26,195	191 000	310 000	2 000	2 800	52393	52618	1,81	0,702

¹⁾ The tolerances are listed in Tables 2, 3 and 4 on Pages B109 and B110 in Cat. RB/A/GB/...

Tapered Roller Bearings (Inch)

Bore Diameter 101,600 – 117,475 mm



Boundary Dimensions (mm)					Basic Load Ratings (N)		Limiting Speeds (min ⁻¹)		Bearing Numbers		Mass (kg) approx	
d	D	T	B	C	C _r	C _{0r}	Grease	Oil	Cone	Cup	Cone	Cup
101,600	157,162	36,512	36,116	26,195	191 000	310 000	2 000	2 800	52400	52618	1,75	0,702
	161,925	36,512	36,116	26,195	191 000	310 000	2 000	2 800	52400	52637	1,75	0,942
	168,275	41,275	41,275	30,162	223 000	345 000	2 000	2 800	687	672	2,15	1,24
	180,975	47,625	48,006	38,100	258 000	375 000	2 000	2 600	780	772	2,88	1,99
	190,500	57,150	57,531	44,450	355 000	500 000	1 900	2 600	861	854	4,13	2,55
	190,500	57,150	57,531	46,038	390 000	520 000	1 900	2 600	HH 221449	HH 221410	4,55	2,24
	212,725	66,675	66,675	53,975	570 000	810 000	1 700	2 200	HH 224335	HH 224310	8,14	3,06
104,775	180,975	47,625	48,006	38,100	258 000	375 000	2 000	2 600	787	772	2,66	1,99
	180,975	47,625	48,006	38,100	258 000	375 000	2 000	2 600	782	772	2,68	1,99
	190,500	47,625	49,212	34,925	296 000	465 000	1 800	2 400	71412	71750	4,0	1,71
106,362	165,100	36,512	36,512	26,988	195 000	320 000	2 000	2 600	56418	56650	1,87	0,861
107,950	158,750	23,020	21,438	15,875	102 000	165 000	2 000	2 800	37425	37625	0,886	0,488
	159,987	34,925	34,925	26,988	164 000	315 000	2 000	2 800	LM 522546	LM 522510	1,65	0,784
	161,925	34,925	34,925	26,988	164 000	280 000	2 000	2 800	48190	48120	1,59	0,83
	165,100	36,512	36,512	26,988	195 000	320 000	2 000	2 600	56425	56650	1,8	0,861
	190,500	47,625	49,212	34,925	296 000	465 000	1 800	2 400	71425	71750	3,79	1,71
	212,725	66,675	66,675	53,975	570 000	810 000	1 700	2 200	HH 224340	HH 224310	7,58	3,06
	109,987	159,987	34,925	34,925	26,988	164 000	315 000	2 000	2 800	LM 522549	LM 522510	1,55
	159,987	34,925	34,925	26,988	164 000	315 000	2 000	2 800	LM 522548	LM 522510	1,53	0,784
109,992	177,800	41,275	41,275	30,162	232 000	375 000	1 800	2 600	64433	64700	2,64	1,11
110,000	165,000	35,000	35,000	26,500	195 000	320 000	2 000	2 600	²⁾ JM 822049	²⁾ JM 822010	1,64	0,842
	180,000	47,000	46,000	38,000	310 000	490 000	1 900	2 600	²⁾ JHM 522649	²⁾ JHM 522610	3,12	1,51
111,125	190,500	47,625	49,212	34,925	296 000	465 000	1 800	2 400	71437	71750	3,58	1,71
114,300	152,400	21,433	21,433	16,670	89 500	178 000	2 000	2 800	L 623149	L 623110	0,725	0,344
	177,800	41,275	41,275	30,162	232 000	375 000	1 800	2 600	64450	64700	2,39	1,11
	180,000	34,925	31,750	25,400	174 000	254 000	1 800	2 400	68450	¹⁾ 68709	1,95	1,0
	190,500	47,625	49,212	34,925	296 000	465 000	1 800	2 400	71450	71750	3,37	1,71
	212,725	66,675	66,675	53,975	475 000	700 000	1 700	2 400	938	932	6,01	4,11
	212,725	66,675	66,675	53,975	570 000	810 000	1 700	2 200	HH 224346	HH 224310	7,01	3,06
	115,087	190,500	47,625	49,212	34,925	296 000	465 000	1 800	2 400	71453	71750	3,31
117,475	180,975	34,925	31,750	25,400	174 000	254 000	1 800	2 400	68462	68712	1,73	1,05

¹⁾ The maximum outside diameter is listed and its tolerance is negative (See Table 8.4.2 on Pages A68 and A69 in Cat. RB/A/GB/...).

²⁾ The tolerances are listed in Tables 2, 3 and 4 on Pages B109 and B110 in Cat. RB/A/GB/...

Tapered Roller Bearings (Inch)

Bore Diameter 120,000 – 165,100 mm

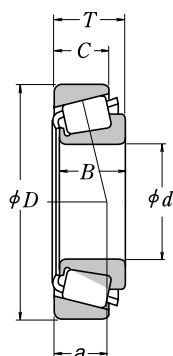

Boundary Dimensions (mm)					Basic Load Ratings (N)		Limiting Speeds (min ⁻¹)		Bearing Numbers		Mass (kg) approx	
d	D	T	B	C	C _r	C _{0r}	Grease	Oil	Cone	Cup	Cone	Cup
120,000	170,000	25,400	25,400	19,050	130 000	219 000	1 900	2 600	²⁾ JL 724348	²⁾ JL 724314	1,08	0,591
	174,625	35,720	36,512	27,783	212 000	385 000	1 900	2 600	¹⁾ M 224748	M 224710	1,9	0,866
120,650	182,562	39,688	38,100	33,338	228 000	445 000	1 800	2 400	48282	48220	2,56	1,14
	206,375	47,625	47,625	34,925	320 000	530 000	1 600	2 200	795	792	4,44	1,9
123,825	182,562	39,688	38,100	33,338	228 000	445 000	1 800	2 400	48286	48220	2,37	1,14
125,000	175,000	25,400	25,400	18,288	134 000	232 000	1 800	2 400	²⁾ JL 725346	²⁾ JL 725316	1,19	0,573
127,000	165,895	18,258	17,462	13,495	84 500	149 000	1 900	2 600	LL 225749	LL 225710	0,647	0,288
	182,562	39,688	38,100	33,338	228 000	445 000	1 800	2 400	48290	48220	2,19	1,14
	196,850	46,038	46,038	38,100	315 000	560 000	1 700	2 200	67388	67322	3,74	1,46
	215,900	47,625	47,625	34,925	287 000	495 000	1 500	2 000	74500	74850	4,92	1,99
128,588	206,375	47,625	47,625	34,925	320 000	530 000	1 600	2 200	799	792	3,86	1,9
130,000	206,375	47,625	47,625	34,925	320 000	530 000	1 600	2 200	797	792	3,76	1,9
130,175	203,200	46,038	46,038	38,100	315 000	560 000	1 700	2 200	67389	67320	3,51	2,06
	206,375	47,625	47,625	34,925	320 000	530 000	1 600	2 200	799 A	792	3,74	1,9
133,350	177,008	25,400	26,195	20,638	124 000	258 000	1 800	2 400	L 327249	L 327210	1,18	0,55
	190,500	39,688	39,688	33,338	240 000	485 000	1 700	2 200	48385	48320	2,58	1,16
	196,850	46,038	46,038	38,100	315 000	560 000	1 700	2 200	67390	67322	3,27	1,46
	215,900	47,625	47,625	34,925	287 000	495 000	1 500	2 000	74525	74850	4,44	1,99
136,525	190,500	39,688	39,688	33,338	240 000	485 000	1 700	2 200	48393	48320	2,37	1,16
	217,488	47,625	47,625	34,925	287 000	495 000	1 500	2 000	74537	74856	4,19	2,13
139,700	187,325	28,575	29,370	23,020	153 000	305 000	1 700	2 200	LM 328448	LM 328410	1,59	0,67
	215,900	47,625	47,625	34,925	287 000	495 000	1 500	2 000	74550	74850	3,93	1,99
	254,000	66,675	66,675	47,625	515 000	830 000	1 300	1 800	99550	99100	9,99	3,83
142,875	200,025	41,275	39,688	34,130	227 000	460 000	1 600	2 200	48685	48620	2,63	1,19
146,050	193,675	28,575	28,575	23,020	170 000	355 000	1 600	2 200	36690	36620	1,64	0,725
	236,538	57,150	56,642	44,450	455 000	720 000	1 400	1 900	HM 231140	HM 231110	6,07	2,93
	254,000	66,675	66,675	47,625	515 000	830 000	1 300	1 800	99575	99100	9,24	3,83
149,225	254,000	66,675	66,675	47,625	515 000	830 000	1 300	1 800	99587	99100	8,86	3,83
152,400	254,000	66,675	66,675	47,625	515 000	830 000	1 300	1 800	99600	99100	8,46	3,83
158,750	225,425	41,275	39,688	33,338	240 000	540 000	1 400	1 900	46780	46720	3,69	1,66
165,100	247,650	47,625	47,625	38,100	345 000	705 000	1 300	1 700	67780	67720	5,83	2,33

¹⁾ The maximum bore diameter is listed and its tolerance is negative (See Table 8.4.1 on Page A68 in Cat. RB/A/GB/...).

²⁾ The tolerances are listed in Tables 2, 3 and 4 on Pages B109 and B110 in Cat. RB/A/GB/...

Tapered Roller Bearings (Inch)

Bore Diameter 170,000 – 206,375 mm



Boundary Dimensions (mm)					Basic Load Ratings (N)		Limiting Speeds (min ⁻¹)		Bearing Numbers		Mass (kg) approx	
d	D	T	B	C	C _r	C _{0r}	Grease	Oil	Cone	Cup	Cone	Cup
170,000	230,000	39,000	38,000	31,000	278 000	520 000	1 300	1 800	¹⁾ JHM 534149	¹⁾ JHM 534110	3,1	1,3
	240,000	46,000	44,500	37,000	380 000	720 000	1 300	1 800	¹⁾ JM 734449	¹⁾ JM 734410	4,42	2,02
174,625	247,650	47,625	47,625	38,100	345 000	705 000	1 300	1 700	67787	67720	4,88	2,33
177,800	227,012	30,162	30,162	23,020	181 000	415 000	1 300	1 800	36990	36920	2,1	0,907
	247,650	47,625	47,625	38,100	345 000	705 000	1 300	1 700	67790	67720	4,56	2,33
	260,350	53,975	53,975	41,275	455 000	835 000	1 200	1 700	M 236849	M 236810	6,49	2,86
190,000	260,000	46,000	44,000	36,500	370 000	730 000	1 100	1 600	¹⁾ JM 738249	¹⁾ JM 738210	4,73	2,2
190,500	266,700	47,625	46,833	38,100	345 000	720 000	1 100	1 500	67885	67820	5,4	2,64
200,000	300,000	65,000	62,000	51,000	615 000	1 130 000	1 000	1 400	¹⁾ JHM 840449	¹⁾ JHM 840410	10,3	5,19
203,200	282,575	46,038	46,038	36,512	365 000	800 000	1 000	1 400	67983	67920	6,03	2,82
206,375	282,575	46,038	46,038	36,512	365 000	800 000	1 000	1 400	67985	67920	5,66	2,82

¹⁾ The tolerances are listed in Tables 2, 3 and 4 on Pages B109 and B110 in Cat. RB/A/GB/...

Spherical Roller Bearings



Bore Size
(multiply last two numbers
by 5 to get bore in mm)

20: 100 mm 48: 240 mm
32: 160 mm 96: 480 mm

500 mm millimeters and larger written as :
/500: 500 mm /710: 710 mm
/630: 630 mm /1000: 1000 mm

Bore Type

Blank: Cylindrical Bore
K: 1:12 Tapered bore
K30: 1:30 Tapered bore

Internal Clearance

C2: Tight
Blank: Normal
C3: Loose
C4: Extra Loose

231

Basic Type

22200: Spherical roller, medium
22300: Spherical roller, heavy
23000: Spherical roller, very light
23100: Spherical roller, light
23200: Spherical roller, medium, wide
23900: Spherical roller, extra light
24000: Spherical roller, very light, wide
24100: Spherical roller, light, wide

72

CAM

Cage Options

CAM: One piece brass cage, guide ring
C,CD: Two piece steel cage guide ring
EA: High capacity steel cage
M: Two piece brass cage,
integral guide flange

K

E4

Lubrication Features

E3: Holes only, outer
E4: Groove & holes, outer
E7: Groove & holes, outer & inner
Blank: No relubrication feature

C3

P53S11

Other Features

P52: Outer ring accuracy
P53: Inner ring accuracy
P55: Both ring accuracy
U22: Special inspection
measure
S11: Inner and outer ring
Heat stabilized
to 200°C

Please refer to the bearing tables for exact part number options



Design, Types, and Features

Shown in the figures, types EA, C, CD, CA, which are designed for high load capacity, are available. Types EA, C and CD have pressed steel cages, and type CA has machined brass cages. Type EA has especially high load capacity, and features such as low torque, and high strength cage. An oil groove and holes are provided in the outer ring to supply lubricant and the bearing numbers are suffixed with E4. To use bearings with oil grooves and holes, it is recommended to provide an oil groove in the housing bore, since the depth of the groove in the bearing is limited. The number and dimensions of the oil groove and holes are shown in Tables 1 and 2. When bearings with a hole for a locking pin to prevent outer ring rotation are required, please inform NSK.

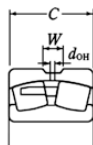

Table 1:
Dimensions of Oil Grooves and Holes (mm)

Nominal Outer Ring Width C		Oil Groove	Hole Diameter \varnothing
over	include	Width W	d_{OH}
18	30	5	2,5
30	40	6	3
40	50	7	4
50	65	8	5
65	80	10	6
80	100	12	8
100	120	15	10
120	160	20	12
160	200	25	15
200	250	30	20
250	315	35	20
315	400	40	25
400	-	40	25,0

Table 2:
Number of Oil Holes

Nominal Outer Ring Width C		Number of holes
over	include	
-	180	4
180	250	6
250	315	6
315	400	6
400	500	6
500	630	8
630	800	8
800	1000	8
1000	1250	8
1250	1600	8
1600	2000	8

Applications

› Continuous Casters (Support roll, Guide roll, Pinch roll, Table roll) › Other Metal Mill Equipment › Shaker Screens and Other Vibratory Equipment › Paper Making Equipment (Calender rolls, Dryer rolls, Fourdrinier, etc.) › Mining Equipment (Drag lines, Gyratory crushers, Continuous miners, Jaw crushers, etc.) › Blowers and Fans › Rubber and Plastic Forming Equipment (Extruders, Granulators, etc.) › Pumps and Compressors (Deep well, Slurry, etc.) › Gears, Drives and Reducers › Construction Equipment › Oil Field Equipment (Pump jacks, Compounders, Derricks, Hoists, etc.) › Overhead Cranes, Crane Hooks, Hoists › Metal Forming Equipment › Railroad Generators and Alternators

Radial Internal Clearances

Nominal Bore Diameter d (mm)		Clearance in Bearings with Cylindrical Bores										Clearance in Bearings with Tapered Bores									
		C2		CN		C3		C4		C5		C2		CN		C3		C4		C5	
over	include	min.	max.	min.	max.	min.	max.	min.	max.	min.	max.	min.	max.	min.	max.	min.	max.	min.	max.	min.	max.
24	30	15	25	25	40	40	55	55	75	75	95	20	30	30	40	40	55	55	75	75	95
30	40	15	30	30	45	45	60	60	80	80	100	25	35	35	50	50	65	65	85	85	105
40	50	20	35	35	55	55	75	75	100	100	125	30	45	45	60	60	80	80	100	100	130
50	65	20	40	40	65	65	90	90	120	120	150	40	55	55	75	75	95	95	120	120	160
65	80	30	50	50	80	80	110	110	145	145	180	50	70	70	95	95	120	120	150	150	200
80	100	35	60	60	100	100	135	135	180	180	225	55	80	80	110	110	140	140	180	180	230
100	120	40	75	75	120	120	160	160	210	210	260	65	100	100	135	135	170	170	220	220	280
120	140	50	95	95	145	145	190	190	240	240	300	80	120	120	160	160	200	200	260	260	330
140	160	60	110	110	170	170	220	220	280	280	350	90	130	130	180	180	230	230	300	300	380
160	180	65	120	120	180	180	240	240	310	310	390	100	140	140	200	200	260	260	340	340	430
180	200	70	130	130	200	200	260	260	340	340	430	110	160	160	220	220	290	290	370	370	470
200	225	80	140	140	220	220	290	290	380	380	470	120	180	180	250	250	320	320	410	410	520
225	250	90	150	150	240	240	320	320	420	420	520	140	200	200	270	270	350	350	450	450	570
250	280	100	170	170	260	260	350	350	460	460	570	150	220	220	300	300	390	390	490	490	620
280	315	110	190	190	280	280	370	370	500	500	630	170	240	240	330	330	430	430	540	540	680
315	355	120	200	200	310	310	410	410	550	550	690	190	270	270	360	360	470	470	590	590	740
355	400	130	220	220	340	340	450	450	600	600	750	210	300	300	400	400	520	520	650	650	820
400	450	140	240	240	370	370	500	500	660	660	820	230	330	330	440	440	570	570	720	720	910
450	500	140	260	260	410	410	550	550	720	720	900	260	370	370	490	490	630	630	790	790	1 000
500	560	150	280	280	440	440	600	600	780	780	1 000	290	410	410	540	540	680	680	870	870	1 100
560	630	170	310	310	480	480	650	650	850	850	1 100	320	460	460	600	600	760	760	980	980	1 230
630	710	190	350	350	530	530	700	700	920	920	1 190	350	510	510	670	670	850	850	1 090	1 090	1 360
710	800	210	390	390	580	580	770	770	1 010	1 010	1 300	390	570	570	750	750	960	960	1 220	1 220	1 500
800	900	230	430	430	650	650	860	860	1 120	1 120	1 440	440	640	640	840	840	1 070	1 070	1 370	1 370	
900	1 000	260	480	480	710	710	930	930	1 220	1 220	1 570	490	710	710	930	930	1 190	1 190	1 520	1 520	1 860
1 000	1 120	290	530	530	780	780	1 020	1 020	1 330	-	-	530	770	770	1 030	1 030	1 300	1 300	1 670	-	-
1 120	1 250	320	580	580	860	860	1 120	1 120	1 460	-	-	570	830	830	1 120	1 120	1 420	1 420	1 830	-	-
1 250	1 400	350	640	640	950	950	1 240	1 240	1 620	-	-	620	910	910	1 230	1 230	1 560	1 560	2 000	-	-

Units: μm

Interchange

Part Number	Description	NSK	SKF	FAG	NTN	SNR
	See Interchange list					
	Polyamide cage			TVPB		
	Steel Cage	C, CD, EA	Blank	Blank	J	A
	Machined Brass Cage	M, CAM	ECA, ECAC	M, MA, MB	L1	M, MB
	Extra Capacity	Blank	E, Explore	E, E1	E	E
	Tight Clearance	C2	C2	C2	C2	J20
	Normal Clearance	Blank	Blank	Blank	Blank	Blank
	Loose Clearance	C3	C3	C3	C3	C3
	Extra Loose Clearance	C4	C4	C4	C4	C4
	Tapered Bore 1:12	K	K	K	K	K
	Tapered Bore 1:30	K30	K30	K30	K30	K30
	Grease Groove and Holes	E4	W33	Blank, S	D1	B33
	Heat Stabilization	S11	Blank	Blank	Blank	Blank
	Vibrating Equipment Specification	U15VS	A15, VA405	T41A	UAVS1	F800, F801

Spherical Roller Bearings

Bore Diameter 20 – 70 mm

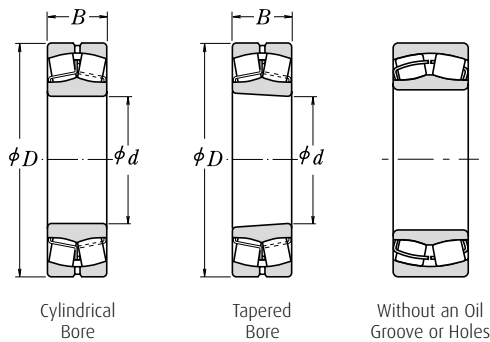

Boundary Dimensions (mm)			Basic Load Ratings (N)		Limiting Speeds (min ⁻¹)		Bearing Numbers		Mass (kg)
d	D	B	C _r	C _{0r}	Grease	Oil	Cylindrical Bore	Tapered Bore ¹⁾	approx
20	52	15	29 300	26 900	6 700	8 500	21304CDE4	21304CDKE4	0,17
25	52	18	37 500	37 000	7 100	9 000	22205CE4	22205CKE4	0,17
	62	17	43 000	40 500	5 300	6 700	21305CDE4	21305CDKE4	0,26
30	62	20	50 000	50 000	6 000	7 500	22206CE4	22206CKE4	0,27
	72	19	55 000	54 000	4 500	6 000	21306CDE4	21306CDKE4	0,39
35	72	23	69 000	71 000	5 300	6 700	22207CE4	22207CKE4	0,42
	80	21	71 500	76 000	4 000	5 300	21307CDE4	21307CDKE4	0,53
40	80	23	113 000	99 500	6 700	8 500	22208EAE4	22208EAKE4	0,50
	90	23	118 000	111 000	6 000	7 500	21308EAE4	21308EAKE4	0,73
	90	33	170 000	153 000	5 300	6 700	22308EAE4	22308EAKE4	0,98
45	85	23	118 000	111 000	6 000	7 500	22209EAE4	22209EAKE4	0,55
	100	25	149 000	144 000	5 000	6 300	21309EAE4	21309EAKE4	0,96
	100	36	207 000	195 000	4 500	5 600	22309EAE4	22309EAKE4	1,34
50	90	23	124 000	119 000	5 600	7 100	22210EAE4	22210EAKE4	0,61
	110	27	178 000	174 000	4 500	5 600	21310EAE4	21310EAKE4	1,21
	110	40	246 000	234 000	4 300	5 300	22310EAE4	22310EAKE4	1,78
55	100	25	149 000	144 000	5 300	6 700	22211EAE4	22211EAKE4	0,81
	120	29	178 000	174 000	4 500	5 600	21311EAE4	21311EAKE4	1,58
	120	43	292 000	292 000	3 800	4 800	22311EAE4	22311EAKE4	2,3
60	95	26	98 500	141 000	3 600	4 500	23012CE4	23012CKE4	0,68
	110	28	178 000	174 000	4 800	6 000	22212EAE4	22212EAKE4	1,1
	130	31	238 000	244 000	3 800	4 800	21312EAE4	21312EAKE4	1,98
	130	46	340 000	340 000	3 600	4 500	22312EAE4	22312EAKE4	2,89
65	120	31	221 000	230 000	4 300	5 300	22213EAE4	22213EAKE4	1,51
	140	33	264 000	275 000	3 600	4 500	21313EAE4	21313EAKE4	2,45
	140	48	375 000	380 000	3 200	4 000	22313EAE4	22313EAKE4	3,52
70	125	31	225 000	232 000	4 000	5 300	22214EAE4	22214EAKE4	1,58
	150	35	310 000	325 000	3 200	4 000	21314EAE4	21314EAKE4	3,0
	150	51	425 000	435 000	3 000	3 800	22314EAE4	22314EAKE4	4,28

¹⁾ The suffix K represents bearings with tapered bores (1 : 12).

An oil groove and holes are standard for the EA type. For the dimensions of adapters and withdrawal sleeves, refer to Pages B354, B355, and B362 in Cat. RB/A/GB/...

Spherical Roller Bearings

Bore Diameter 75 – 110 mm

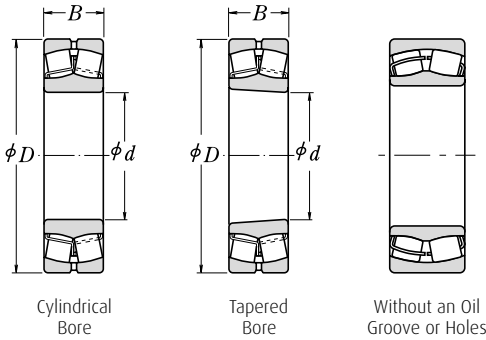

Boundary Dimensions (mm)			Basic Load Ratings (N)		Limiting Speeds (min ⁻¹)		Bearing Numbers		Mass (kg)
d	D	B	C _r	C _{0r}	Grease	Oil	Cylindrical Bore	Tapered Bore ¹⁾	approx
75	130	31	238 000	244 000	4 000	5 000	22215EAE4	22215EAKE4	1,64
	160	37	310 000	325 000	3 200	4 000	21315EAE4	21315EAKE4	3,64
	160	55	485 000	505 000	2 800	3 600	22315EAE4	22315EAKE4	5,26
80	140	33	264 000	275 000	3 600	4 500	22216EAE4	22216EAKE4	2,01
	170	39	355 000	375 000	3 000	3 800	21316EAE4	21316EAKE4	4,32
	170	58	540 000	565 000	2 600	3 400	22316EAE4	22316EAKE4	6,23
85	150	36	310 000	325 000	3 400	4 300	22217EAE4	22217EAKE4	2,54
	180	41	360 000	395 000	3 000	4 000	21317EAE4	21317EAKE4	5,2
	180	60	600 000	630 000	2 400	3 200	22317EAE4	22317EAKE4	7,23
90	160	40	360 000	395 000	3 200	4 000	22218EAE4	22218EAKE4	3,3
	160	52,4	340 000	490 000	1 800	2 400	23218CE4	23218CKE4	4,51
	190	43	415 000	450 000	2 800	3 600	21318EAE4	21318EAKE4	6,1
	190	64	665 000	705 000	2 400	3 000	22318EAE4	22318EAKE4	8,56
95	170	43	415 000	450 000	3 000	3 800	22219EAE4	22219EAKE4	4,04
	170	55,6	370 000	525 000	1 700	2 200	23219CAE4	23219CAKE4	5,33
	200	45	345 000	435 000	1 500	2 000	21319CE4	21319CKE4	6,92
	200	67	735 000	780 000	2 200	2 800	22319EAE4	22319EAKE4	9,91
100	150	37	212 000	335 000	2 200	2 800	23020CDE4	23020CDKE4	2,31
	150	50	276 000	470 000	1 800	2 400	24020CE4	24020CK30E4	3,08
	165	52	345 000	530 000	1 700	2 200	23120CE4	23120CKE4	4,38
	165	65	345 000	535 000	1 700	2 200	24120CAE4	24120CAK30E4	5,42
	180	46	455 000	490 000	2 800	3 600	22220EAE4	22220EAKE4	4,84
	180	60,3	420 000	605 000	1 600	2 200	23220CE4	23220CKE4	6,6
	215	47	395 000	485 000	1 400	1 900	21320CE4	21320CKE4	8,46
	215	73	860 000	930 000	2 000	2 600	22320EAE4	22320EAKE4	12,7
110	170	45	293 000	465 000	2 000	2 400	23022CDE4	23022CDKE4	3,76
	170	60	380 000	645 000	1 600	2 200	24022CE4	24022CK30E4	4,96
	180	56	385 000	630 000	1 600	2 000	23122CE4	23122CKE4	5,7
	180	69	460 000	750 000	1 600	2 000	24122CE4	24122CK30E4	6,84
	200	53	605 000	645 000	2 600	3 200	22222EAE4	22222EAKE4	6,99
	200	69,8	515 000	760 000	1 500	1 900	23222CE4	23222CKE4	9,54
	240	50	450 000	545 000	1 300	1 700	21322CAE4	21322CAKE4	11,2
	240	80	1 030 000	1 120 000	1 900	2 400	22322EAE4	22322EAKE4	17,6

¹⁾ The suffix K represents bearings with tapered bores (1 : 12).

An oil groove and holes are standard for the EA type. For the dimensions of adapters and withdrawal sleeves, refer to Pages B354, B355, and B362 in Cat. RB/A/GB/...

Spherical Roller Bearings

Bore Diameter 120 – 150 mm



Boundary Dimensions (mm)			Basic Load Ratings (N)		Limiting Speeds (min ⁻¹)		Bearing Numbers		Mass (kg)
d	D	B	C _r	C _{0r}	Grease	Oil	Cylindrical Bore	Tapered Bore ¹⁾	approx
120	180	46	315 000	525 000	1 800	2 200	23024CDE4	23024CDKE4	4,11
	180	60	395 000	705 000	1 500	2 000	24024CE4	24024CK30E4	5,33
	200	62	465 000	720 000	1 400	1 800	23124CE4	23124CKE4	7,85
	200	80	575 000	950 000	1 400	1 800	24124CE4	24124CK30E4	10
	215	58	685 000	765 000	2 400	3 000	22224EAE4	22224EAKE4	8,8
	215	76	630 000	970 000	1 300	1 700	23224CE4	23224CKE4	12,1
	260	86	1 190 000	1 320 000	1 700	2 200	22324EAE4	22324EAKE4	22,2
130	200	52	400 000	655 000	1 700	2 000	23026CDE4	23026CDKE4	5,98
	200	69	495 000	865 000	1 400	1 800	24026CE4	24026CK30E4	7,84
	210	64	505 000	825 000	1 300	1 700	23126CE4	23126CKE4	8,69
	210	80	590 000	1 010 000	1 300	1 700	24126CE4	24126CK30E4	10,7
	230	64	820 000	940 000	2 200	2 600	22226EAE4	22226EAKE4	11
	230	80	700 000	1 080 000	1 200	1 600	23226CE4	23226CKE4	14,3
	280	93	995 000	1 350 000	1 300	1 600	22326CE4	22326CKE4	28,1
140	210	53	420 000	715 000	1 600	1 900	23028CDE4	23028CDKE4	6,49
	210	69	525 000	945 000	1 300	1 700	24028CE4	24028CK30E4	8,37
	225	68	580 000	945 000	1 200	1 600	23128CE4	23128CKE4	10,5
	225	85	670 000	1 160 000	1 200	1 600	24128CE4	24128CK30E4	13
	250	68	645 000	930 000	1 400	1 700	22228CDE4	22228CDKE4	14,5
	250	88	835 000	1 300 000	1 100	1 500	23228CE4	23228CKE4	18,8
	300	102	1 160 000	1 590 000	1 200	1 500	22328CE4	22328CKE4	35,4
150	225	56	470 000	815 000	1 400	1 800	23030CDE4	23030CDKE4	7,9
	225	75	590 000	1 090 000	1 200	1 500	24030CE4	24030CK30E4	10,5
	250	80	725 000	1 180 000	1 100	1 400	23130CE4	23130CKE4	15,8
	250	100	890 000	1 530 000	1 100	1 400	24130CE4	24130CK30E4	19,8
	270	73	765 000	1 120 000	1 300	1 600	22230CDE4	22230CDKE4	18,4
	270	96	975 000	1 560 000	1 100	1 400	23230CE4	23230CKE4	24,2
	320	108	1 220 000	1 690 000	1 100	1 400	22330CAE4	22330CAKE4	41,5

¹⁾ The suffix K represents bearings with tapered bores (1 : 12).

An oil groove and holes are standard for the EA type. For the dimensions of adapters and withdrawal sleeves, refer to Pages B354, B355, and B362 in Cat. RB/A/GB/...

Spherical Roller Bearings

Bore Diameter 160 – 200 mm

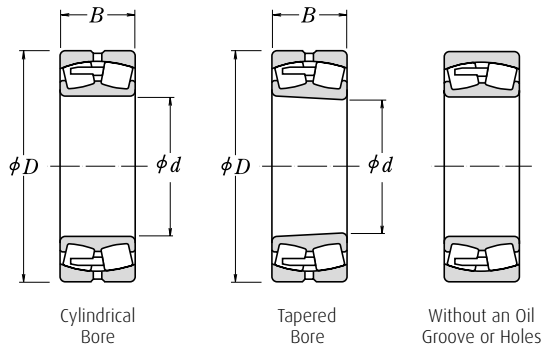

Boundary Dimensions (mm)			Basic Load Ratings (N)		Limiting Speeds (min ⁻¹)		Bearing Numbers		Mass (kg)
d	D	B	C _r	C _{0r}	Grease	Oil	Cylindrical Bore	Tapered Bore ¹⁾	approx
160	220	45	360 000	675 000	1 400	1 800	23932CAE4	23932CAKE4	4,97
	240	60	540 000	955 000	1 300	1 700	23032CDE4	23032CDKE4	9,66
	240	80	680 000	1 260 000	1 100	1 400	24032CE4	24032CK30E4	12,7
	270	86	855 000	1 400 000	1 000	1 300	23132CE4	23132CKE4	20,3
	270	109	1 040 000	1 760 000	1 000	1 300	24132CE4	24132CK30E4	25,4
	290	80	910 000	1 320 000	1 200	1 500	22232CDE4	22232CDKE4	23,1
	290	104	1 100 000	1 770 000	1 000	1 300	23232CE4	23232CKE4	30,5
	340	114	1 360 000	1 900 000	1 100	1 300	22332CAE4	22332CAKE4	49,3
170	230	45	350 000	660 000	1 400	1 800	23934BCAE4	23934BCAKE4	5,38
	260	67	640 000	1 090 000	1 200	1 600	23034CDE4	23034CDKE4	13
	260	90	825 000	1 520 000	1 000	1 300	24034CE4	24034CK30E4	17,3
	280	88	940 000	1 570 000	1 000	1 300	23134CE4	23134CKE4	21,8
	280	109	1 080 000	1 860 000	1 000	1 300	24134CE4	24134CK30E4	26,6
	310	86	990 000	1 500 000	1 100	1 400	22234CDE4	22234CDKE4	28,8
	310	110	1 200 000	1 910 000	900	1 200	23234CE4	23234CKE4	36,4
	360	120	1 580 000	2 110 000	1 000	1 200	22334CAE4	22334CAKE4	57,9
180	250	52	470 000	890 000	1 200	1 600	23936CAE4	23936CAKE4	7,64
	280	74	750 000	1 270 000	1 200	1 400	23036CDE4	23036CDKE4	17,1
	280	100	965 000	1 750 000	950	1 200	24036CE4	24036CK30E4	22,7
	300	96	1 050 000	1 760 000	900	1 200	23136CE4	23136CKE4	27,5
	300	118	1 190 000	2 040 000	900	1 200	24136CE4	24136CK30E4	33,1
	320	86	1 020 000	1 540 000	1 100	1 300	22236CDE4	22236CDKE4	30,2
	320	112	1 300 000	2 110 000	850	1 100	23236CE4	23236CKE4	38,9
	380	126	1 740 000	2 340 000	950	1 200	22336CAE4	22336CAKE4	67
190	260	52	460 000	875 000	1 200	1 500	23938CAE4	23938CAKE4	8,03
	290	75	775 000	1 350 000	1 100	1 400	23038CAE4	23038CAKE4	17,6
	290	100	975 000	1 840 000	900	1 200	24038CE4	24038CK30E4	24
	320	104	1 190 000	2 020 000	850	1 100	23138CE4	23138CKE4	34,5
	320	128	1 370 000	2 330 000	850	1 100	24138CE4	24138CK30E4	41,5
	340	92	1 140 000	1 730 000	1 000	1 200	22238CAE4	22238CAKE4	35,5
	340	120	1 440 000	2 350 000	800	1 100	23238CE4	23238CKE4	47,6
	400	132	1 890 000	2 590 000	900	1 100	22338CAE4	22338CAKE4	77,6
200	280	60	570 000	1 060 000	1 100	1 400	23940CAE4	23940CAKE4	11
	310	82	940 000	1 700 000	1 000	1 300	23040CAE4	23040CAKE4	22,6
	310	109	1 140 000	2 120 000	850	1 100	24040CE4	24040CK30E4	30,4
	340	112	1 360 000	2 330 000	800	1 000	23140CE4	23140CKE4	42,7
	340	140	1 570 000	2 670 000	800	1 000	24140CE4	24140CK30E4	51,3
	360	98	1 300 000	2 010 000	950	1 200	22240CAE4	22240CAKE4	42,6
	360	128	1 660 000	2 750 000	750	1 000	23240CE4	23240CKE4	57,1
	420	138	2 000 000	2 990 000	850	1 000	22340CAE4	22340CAKE4	92,6

¹⁾ The suffix K represents bearings with tapered bores (1 : 12 or 1 : 30)

For the dimensions of adapters and withdrawal sleeves, refer to Pages B358 and B364 in Cat. RB/A/GB/...

Spherical Roller Bearings

Bore Diameter 220 – 300 mm



Boundary Dimensions (mm)			Basic Load Ratings (N)		Limiting Speeds (min ⁻¹)		Bearing Numbers		Mass (kg)
d	D	B	C _r	C _{0r}	Grease	Oil	Cylindrical Bore	Tapered Bore ¹⁾	approx
220	300	60	625 000	1 240 000	1 000	1 300	23944CAE4	23944CAKE4	12,2
	340	90	1 090 000	1 980 000	950	1 200	23044CAE4	23044CAKE4	29,7
	340	118	1 360 000	2 600 000	750	1 000	24044CE4	24044CK30E4	40,5
	370	120	1 570 000	2 710 000	710	950	23144CE4	23144CKE4	53
	370	150	1 800 000	3 200 000	710	950	24144CE4	24144CK30E4	66,7
	400	108	1 570 000	2 430 000	850	1 000	22244CAE4	22244CAKE4	59
	400	144	2 020 000	3 400 000	670	900	23244CE4	23244CKE4	80,4
	460	145	2 350 000	3 400 000	750	950	22344CAE4	22344CAKE4	116
240	320	60	635 000	1 300 000	950	1 200	23948CAE4	23948CAKE4	13,3
	360	92	1 160 000	2 140 000	850	1 100	23048CAE4	23048CAKE4	32,6
	360	118	1 390 000	2 730 000	710	950	24048CE4	24048CK30E4	43,4
	400	128	1 790 000	3 100 000	670	850	23148CE4	23148CKE4	66,9
	400	160	2 130 000	3 800 000	670	850	24148CE4	24148CK30E4	79,5
	440	120	1 870 000	2 890 000	750	950	22248CAE4	22248CAKE4	80,2
	440	160	2 440 000	4 050 000	630	800	23248CAE4	23248CAKE4	106
	500	155	2 600 000	3 800 000	670	850	22348CAE4	22348CAKE4	147
260	360	75	930 000	1 870 000	850	1 000	23952CAE4	23952CAKE4	23
	400	104	1 430 000	2 580 000	800	950	23052CAE4	23052CAKE4	46,6
	400	140	1 810 000	3 500 000	630	850	24052CAE4	24052CAK30E4	62,6
	440	144	2 160 000	3 750 000	600	800	23152CAE4	23152CAKE4	88,2
	440	180	2 560 000	4 700 000	600	800	24152CAE4	24152CAK30E4	109
	480	130	2 180 000	3 400 000	670	850	22252CAE4	22252CAKE4	104
	480	174	2 740 000	4 550 000	560	750	23252CAE4	23252CAKE4	137
	540	165	3 100 000	4 600 000	630	800	22352CAE4	22352CAKE4	180
280	380	75	925 000	1 950 000	800	950	23956CAE4	23956CAKE4	24,5
	420	106	1 540 000	2 950 000	710	900	23056CAE4	23056CAKE4	50,5
	420	140	1 880 000	3 800 000	600	800	24056CAE4	24056CAK30E4	66,4
	460	146	2 230 000	4 000 000	560	750	23156CAE4	23156CAKE4	94,3
	460	180	2 640 000	5 000 000	560	750	24156CAE4	24156CAK30E4	115
	500	130	2 280 000	3 650 000	630	800	22256CAE4	22256CAKE4	110
	500	176	2 880 000	4 900 000	530	670	23256CAE4	23256CAKE4	147
	580	175	3 500 000	5 150 000	560	710	22356CAE4	22356CAKE4	221
300	420	90	1 230 000	2 490 000	710	900	23960CAE4	23960CAKE4	38,2
	460	118	1 920 000	3 700 000	670	850	23060CAE4	23060CAKE4	70,5
	460	160	2 310 000	4 600 000	530	710	24060CAE4	24060CAK30E4	93,6
	500	160	2 670 000	4 800 000	500	670	23160CAE4	23160CAKE4	125
	500	200	3 100 000	5 800 000	500	670	24160CAE4	24160CAK30E4	152
	540	140	2 610 000	4 250 000	600	750	22260CAE4	22260CAKE4	139
	540	192	3 400 000	5 900 000	480	630	23260CAE4	23260CAKE4	189

¹⁾ The suffix K represents bearings with tapered bores (1 : 12 or 1 : 30)

For the dimensions of adapters and withdrawal sleeves, refer to Pages B359 and B365 in Cat. RB/A/GB/...

Spherical Roller Bearings

Bore Diameter 320 – 420 mm

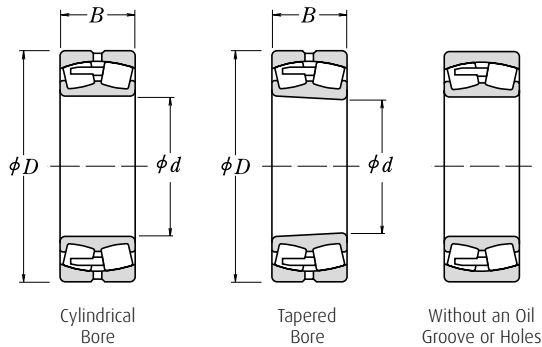

Boundary Dimensions (mm)			Basic Load Ratings (N)		Limiting Speeds (min ⁻¹)		Bearing Numbers		Mass (kg)
d	D	B	C _r	C _{0r}	Grease	Oil	Cylindrical Bore	Tapered Bore ¹⁾	approx
320	440	90	1 300 000	2 750 000	670	850	23964CAE4	23964CAKE4	40,6
	480	121	1 960 000	3 850 000	630	800	23064CAE4	23064CAKE4	75,6
	480	160	2 440 000	5 050 000	500	670	24064CAE4	24064CAK30E4	99,7
	540	176	3 050 000	5 500 000	480	600	23164CAE4	23164CAKE4	162
	540	218	3 550 000	6 650 000	480	600	24164CAE4	24164CAK30E4	196
	580	150	2 990 000	4 850 000	530	670	22264CAE4	22264CAKE4	174
	580	208	3 900 000	6 900 000	450	600	23264CAE4	23264CAKE4	239
340	460	90	1 330 000	2 840 000	630	800	23968CAE4	23968CAKE4	42,4
	520	133	2 280 000	4 400 000	560	710	23068CAE4	23068CAKE4	101
	520	180	2 920 000	6 050 000	480	600	24068CAE4	24068CAK30E4	135
	580	190	3 600 000	6 600 000	430	560	23168CAE4	23168CAKE4	206
	580	243	4 250 000	7 900 000	430	560	24168CAE4	24168CAK30E4	257
	620	224	4 400 000	7 800 000	400	530	23268CAE4	23268CAKE4	295
360	480	90	1 390 000	3 050 000	600	750	23972CAE4	23972CAKE4	44,7
	540	134	2 390 000	4 700 000	530	670	23072CAE4	23072CAKE4	106
	540	180	2 930 000	6 100 000	450	600	24072CAE4	24072CAK30E4	139
	600	192	3 800 000	7 100 000	400	530	23172CAE4	23172CAKE4	217
	600	243	4 200 000	8 000 000	400	530	24172CAE4	24172CAK30E4	264
	650	232	4 800 000	8 550 000	380	500	23272CAE4	23272CAKE4	342
380	520	106	1 870 000	4 100 000	530	670	23976CAE4	23976CAKE4	65,4
	560	135	2 500 000	5 100 000	530	630	23076CAE4	23076CAKE4	113
	560	180	3 050 000	6 600 000	430	560	24076CAE4	24076CAK30E4	148
	620	194	4 000 000	7 600 000	400	500	23176CAE4	23176CAKE4	229
	620	243	4 350 000	8 450 000	400	500	24176CAE4	24176CAK30E4	275
	680	240	5 150 000	9 200 000	360	480	23276CAE4	23276CAKE4	372
400	540	106	1 890 000	4 250 000	530	630	23980CAE4	23980CAKE4	69,1
	600	148	2 970 000	5 900 000	480	600	23080CAE4	23080CAKE4	146
	600	200	3 600 000	7 600 000	400	500	24080CAE4	24080CAK30E4	193
	650	200	4 150 000	7 900 000	380	480	23180CAE4	23180CAKE4	257
	650	250	4 950 000	10 100 000	380	480	24180CAE4	24180CAK30E4	316
	720	256	5 800 000	10 400 000	340	450	23280CAE4	23280CAKE4	449
420	560	106	1 870 000	4 250 000	500	600	23984CAE4	23984CAKE4	71,6
	620	150	2 910 000	5 850 000	450	560	23084CAE4	23084CAKE4	151
	620	200	3 750 000	8 100 000	380	480	24084CAE4	24084CAK30E4	199
	700	224	5 000 000	9 400 000	340	450	23184CAE4	23184CAKE4	341
	700	280	6 000 000	12 000 000	340	450	24184CAE4	24184CAK30E4	421
	760	272	6 450 000	11 700 000	320	430	23284CAE4	23284CAKE4	534

¹⁾ The suffix K represents bearings with tapered bores (1 : 12 or 1 : 30)

For the dimensions of adapters and withdrawal sleeves, refer to Pages B358 and B364 in Cat. RB/A/GB/...

Spherical Roller Bearings

Bore Diameter 440 – 560 mm



Boundary Dimensions (mm)			Basic Load Ratings (N)		Limiting Speeds (min ⁻¹)		Bearing Numbers		Mass (kg)
d	D	B	C _r	C _{0r}	Grease	Oil	Cylindrical Bore	Tapered Bore ¹⁾	approx
440	600	118	2 190 000	4 800 000	450	560	23988CAE4	23988CAKE4	96,3
	650	157	3 150 000	6 350 000	430	530	23088CAE4	23088CAKE4	173
	650	212	4 150 000	9 100 000	360	450	24088CAE4	24088CAK30E4	237
	720	226	5 300 000	10 300 000	320	430	23188CAE4	23188CAKE4	360
	720	280	6 000 000	12 100 000	320	430	24188CAE4	24188CAK30E4	433
	790	280	6 900 000	12 800 000	300	400	23288CAE4	23288CAKE4	594
460	620	118	2 220 000	4 950 000	430	530	23992CAE4	23992CAKE4	100
	680	163	3 450 000	7 100 000	400	500	23092CAE4	23092CAKE4	201
	680	218	4 500 000	9 950 000	340	430	24092CAE4	24092CAK30E4	266
	760	240	5 700 000	10 900 000	300	400	23192CAE4	23192CAKE4	423
	760	300	6 300 000	12 400 000	300	400	24192CAE4	24192CAK30E4	512
	830	296	7 350 000	13 700 000	280	380	23292CAE4	23292CAKE4	691
480	650	128	2 580 000	5 850 000	400	500	23996CAE4	23996CAKE4	121
	700	165	3 800 000	7 950 000	400	480	23096CAE4	23096CAKE4	211
	700	218	4 600 000	10 200 000	320	430	24096CAE4	24096CAK30E4	270
	790	248	6 050 000	11 700 000	300	380	23196CAE4	23196CAKE4	475
	790	308	7 150 000	14 600 000	300	380	24196CAE4	24196CAK30E4	567
	870	310	7 850 000	14 400 000	260	360	23296CAE4	23296CAKE4	795
500	670	128	2 460 000	5 550 000	400	500	239/500CAE4	239/500CAKE4	124
	720	167	3 750 000	8 100 000	380	480	230/500CAE4	230/500CAKE4	220
	720	218	4 450 000	9 900 000	300	400	240/500CAE4	240/500CAK30E4	276
	830	264	6 850 000	13 400 000	280	360	231/500CAE4	231/500CAKE4	567
	830	325	8 000 000	16 000 000	280	360	241/500CAE4	241/500CAK30E4	666
	920	336	9 000 000	16 600 000	260	320	232/500CAE4	232/500CAKE4	969
530	710	136	2 930 000	6 800 000	360	450	239/530CAE4	239/530CAKE4	149
	780	185	4 400 000	9 200 000	340	430	230/530CAE4	230/530CAKE4	298
	780	250	5 400 000	11 800 000	280	360	240/530CAE4	240/530CAK30E4	390
	870	272	7 150 000	14 100 000	260	340	231/530CAE4	231/530CAKE4	628
	870	335	8 500 000	17 500 000	260	340	241/530CAE4	241/530CAK30E4	773
	980	355	10 100 000	18 800 000	240	300	232/530CAE4	232/530CAKE4	1170
560	750	140	3 100 000	7 250 000	340	430	239/560CAE4	239/560CAKE4	172
	820	195	5 000 000	10 700 000	320	400	230/560CAE4	230/560CAKE4	344
	820	258	5 950 000	13 300 000	260	340	240/560CAE4	240/560CAK30E4	440
	920	280	7 850 000	15 500 000	240	320	231/560CAE4	231/560CAKE4	727
	920	355	9 400 000	19 600 000	240	320	241/560CAE4	241/560CAK30E4	886
	1 030	365	10 900 000	20 500 000	220	280	232/560CAE4	232/560CAKE4	1320

¹⁾ The suffix K represents bearings with tapered bores (1 : 12 or 1 : 30)

For the dimensions of adapters and withdrawal sleeves, refer to Pages B361 and B367 in Cat. RB/A/GB/...

Thrust Bearings

Ball Thrust Bearings



Series

- 1: Extra light
- 2: Light
- 3: Medium
- 4: Heavy
- XLT: Extra light
- LT: Light
- MT: Medium

Cage Type

- Blank: Steel
- M: Brass

53

2

05

M

U

Basic Type & Design

- 51: Ball Thrust, single direction, Metric
- 52: Ball Thrust, double direction, Metric
- 53: Ball Thrust, single direction, w/aligning seat, Metric
- 54: Ball Thrust, double direction, w/aligning seat, Metric
- XLT, LT, MT: Ball Thrust, single direction, Inch

Bore Size

- Metric:
(04 and up: multiply last two numbers by 5 to get bore in mm)
- | | |
|-----------|------------|
| 00: 10 mm | 04: 20 mm |
| 01: 12 mm | 05: 25 mm |
| 02: 15 mm | 12: 60 mm |
| 03: 17 mm | 20: 100 mm |
- Inch: directly indicated

Other Features

- U: w/Aligning seat washer
- X: Modified boundary to ISO
- P5: Precision Class 5 (ABEC 5)

Design, Types, and Features

Ball Thrust Bearings are composed of washer-like bearing rings with raceway grooves for the balls. The ring attached to the shaft is called the inner ring or tight washer and the ring attached to the housing is called the outer ring or loose washer.

In double direction thrust ball bearings there are three rings, with the center ring fixed to the shaft. Single direction thrust ball bearings can support axial loads in one direction only; double direction, in two. Both are available with an aligning seat and washer beneath the outer ring to compensate for shaft misalignment or deflection.

Cylindrical Roller Thrust Bearings are thrust bearings containing cylindrical rollers. They can sustain only axial loads, but they are suitable for heavy loads and have high axial rigidity. The cages are machined brass.

Spherical Thrust Roller Bearings have a spherical raceway in the outer ring with the rollers diagonally arranged in a single row. These bearings have a very high axial load capacity and are capable of taking moderate radial loads when an axial load is imposed. Because of the configuration of their rolling elements, spherical roller thrust bearings are capable of handling misalignment and are suited for moderate speed operation.

Thrust Bearings

Spherical Thrust Roller Bearings



Bore Size
(05 and up: multiply last two numbers by 5 to get bore in mm)
12: 60 mm 48: 240 mm
20: 100 mm 96: 480 mm
500 millimeters and larger written as:
/500: 500 mm /710: 710 mm
/630: 630 mm /1000: 1000 mm

293

26

E

Basic Type & Design

292xx: Spherical Roller Thrust, Light
293xx: Spherical Roller Thrust, Medium
294xx: Spherical Roller Thrust, Heavy

Cage Type

E: Pressed Steel
M: Machined Brass
(not always shown in the part number)

Please refer to the bearing tables for exact part number options

Applications

Listed below are popular applications for the two thrust bearing styles shown in this section. They are ball thrust bearings and spherical roller thrust bearings. Also available, but not shown, are cylindrical roller thrust bearings (TMP) and tapered roller thrust bearings (TT, TTF or V-Flat). Please consult an NSK representative for more information.

The ball thrust bearings are designed to handle thrust loads while operating at moderate speeds.

These bearings can be ordered with an aligning seat and aligning washer if misalignment or deflection can not be avoided.

The spherical thrust bearings are designed to handle very heavy thrust loads in one direction while operating at low to moderate speeds. The design of the spherical thrust will also allow for some radial load while thrust load is imposed.

The spherical shape of the outer ring raceway makes these bearings excellent for handling misalignment.

Ball Thrust Bearings

› Screw Jacks › Machine Tool Spindle Tail Stock › Vertical Openers (Spinning and Weaving Machines)

Spherical Thrust Bearings

› Deep Well Pumps › Centrifugal Pumps › Power Plant Preheater › Coal Pulverizer › Plastic Forming Equipment
› Crane Hook › Industrial Gear Boxes › Axial Piston Pumps

Thrust Bearings

Single-direction Thrust Ball Bearings, Bore Diameter 10 – 50 mm

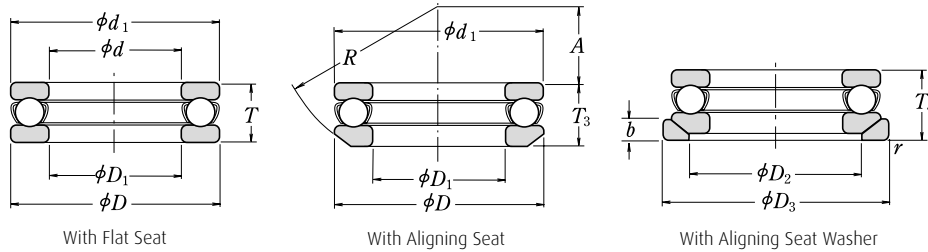

Boundary Dimensions (mm)					Bearing Numbers	Basic Load Ratings (N)		Limiting Speeds (min ⁻¹)		Mass (kg) approx	
d	D_1	D	d_1	T		With Flat Seat		Grease	Oil		
10	11	24	24	9	51100	10 100	14 000	6 700	10 000	0,019	
	12	26	26	11		51200	12 800	17 100	6 000	9 000	0,028
12	13	26	26	9	51101	10 400	15 400	6 700	10 000	0,021	
	14	28	28	11		51201	13 300	19 000	5 600	8 500	0,031
15	16	28	28	9	51102	10 600	16 800	6 300	9 500	0,023	
	17	32	32	12		51202	16 700	24 800	5 000	7 500	0,043
17	18	30	30	9	51103	11 400	19 500	6 000	9 000	0,025	
	19	35	35	12		51203	17 300	27 300	4 800	7 500	0,050
20	21	35	35	10	51104	15 100	26 600	5 300	8 000	0,037	
	22	40	40	14		51204	22 500	37 500	4 300	6 300	0,077
25	26	42	42	11	51105	19 700	37 000	4 800	7 100	0,056	
	27	47	47	15		51205	28 000	50 500	3 800	5 600	0,111
	27	52	52	18		51305	36 000	61 500	3 200	5 000	0,169
	27	60	60	24		51405	56 000	89 500	2 600	4 000	0,334
30	32	47	47	11	51106	20 600	42 000	4 300	6 700	0,064	
	32	52	52	16		51206	29 500	58 000	3 400	5 300	0,137
	32	60	60	21		51306	43 000	78 500	2 800	4 300	0,267
	32	70	70	28		51406	73 000	126 000	2 200	3 400	0,519
35	37	52	52	12	51107	22 100	49 500	4 000	6 000	0,081	
	37	62	62	18		51207	39 500	78 000	3 000	4 500	0,21
	37	68	68	24		51307	56 000	105 000	2 400	3 800	0,386
	37	80	80	32		51407	87 500	155 000	2 000	3 000	0,769
40	42	60	60	13	51108	27 100	63 000	3 600	5 300	0,12	
	42	68	68	19		51208	47 500	98 500	2 800	4 300	0,27
	42	78	78	26		51308	70 000	135 000	2 200	3 400	0,536
	42	90	90	36		51408	103 000	188 000	1 700	2 600	1,1
45	47	65	65	14	51109	28 100	69 000	3 400	5 000	0,143	
	47	73	73	20		51209	48 000	105 000	2 600	4 000	0,31
	47	85	85	28		51309	80 500	163 000	2 000	3 000	0,672
	47	100	100	39		51409	128 000	246 000	1 600	2 400	1,46
50	52	70	70	14	51110	29 000	75 500	3 200	4 800	0,153	
	52	78	78	22		51210	49 000	111 000	2 400	3 600	0,378
	52	95	95	31		51310	97 500	202 000	1 800	2 800	0,931
	52	110	110	43		51410	147 000	288 000	1 400	2 200	1,94

For all dimensions and specifications refer to Cat. RB/A/GB/... from page B203 to B229.

Thrust Bearings

Single-direction Thrust Ball Bearings, Bore Diameter 55 – 100 mm



Boundary Dimensions (mm)					Bearing Numbers	Basic Load Ratings (N)		Limiting Speeds (min ⁻¹)		Mass (kg) approx
<i>d</i>	<i>D</i> ₁	<i>D</i>	<i>d</i> ₁	<i>T</i>		<i>C</i> _a	<i>C</i> _{0a}	Grease	Oil	
55	57	78	78	16	51111	35 000	93 000	2 800	4 300	0,227
	57	90	90	25	51211	70 000	159 000	2 200	3 200	0,599
	57	105	105	35	51311	115 000	244 000	1 600	2 400	1,31
	57	120	120	48	51411	181 000	350 000	1 300	1 900	2,58
60	62	85	85	17	51112	41 500	113 000	2 600	4 000	0,281
	62	95	95	26	51212	71 500	169 000	2 000	3 000	0,673
	62	110	110	35	51312	119 000	263 000	1 600	2 400	1,4
	62	130	130	51	51412	202 000	395 000	1 200	1 800	3,16
65	67	90	90	18	51113	42 000	117 000	2 400	3 800	0,324
	67	100	100	27	51213	75 500	189 000	1 900	2 800	0,756
	67	115	115	36	51313	123 000	282 000	1 500	2 400	1,54
	68	140	140	56	51413	234 000	495 000	1 100	1 700	4,1
70	72	95	95	18	51114	43 500	127 000	2 400	3 600	0,346
	72	105	105	27	51214	74 000	189 000	1 900	2 800	0,793
	72	125	125	40	51314	137 000	315 000	1 400	2 000	2,0
	73	150	150	60	51414	252 000	555 000	1 000	1 500	5,05
75	77	100	100	19	51115	43 500	131 000	2 200	3 400	0,389
	77	110	110	27	51215	78 000	209 000	1 800	2 800	0,845
	77	135	135	44	51315	159 000	365 000	1 300	1 900	2,6
	78	160	160	65	51415	254 000	560 000	950	1 400	6,15
80	82	105	105	19	51116	45 000	141 000	2 200	3 400	0,417
	82	115	115	28	51216	79 000	218 000	1 800	2 600	0,931
	82	140	140	44	51316	164 000	395 000	1 300	1 900	2,74
	83	170	170	68	51416	272 000	620 000	900	1 300	7,21
85	87	110	110	19	51117	46 500	150 000	2 200	3 200	0,44
	88	125	125	31	51217	96 000	264 000	1 600	2 400	1,22
	88	150	150	49	51317	207 000	490 000	1 100	1 700	3,57
	88	180	177	72	51417X	310 000	755 000	850	1 300	8,51
90	92	120	120	22	51118	60 000	190 000	1 900	3 000	0,646
	93	135	135	35	51218	114 000	310 000	1 400	2 200	1,69
	93	155	155	50	51318	214 000	525 000	1 100	1 700	3,83
	93	190	187	77	51418X	330 000	825 000	800	1 200	10,2
100	102	135	135	25	51120	86 000	268 000	1 700	2 600	0,96
	103	150	150	38	51220	135 000	375 000	1 300	2 000	2,25
	103	170	170	55	51320	239 000	595 000	1 000	1 500	4,98
	103	210	205	85	51420X	370 000	985 000	710	1 100	14,8

For all dimensions and specifications refer to Cat. RB/A/GB/... from page B203 to B229.

Thrust Bearings

Single-direction Thrust Ball Bearings, Bore Diameter 110 – 190 mm

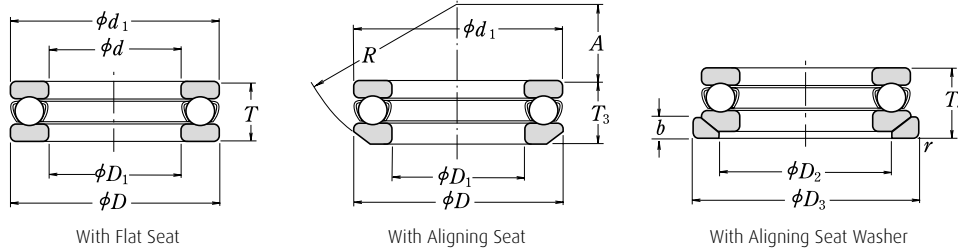

Boundary Dimensions (mm)					Bearing Numbers	Basic Load Ratings (N)		Limiting Speeds (min ⁻¹)		Mass (kg) approx
d	D _i	D	d _i	T		With Flat Seat	C _a	C _{0a}	Grease	
110	112	145	145	25	51122	88 000	288 000	1 700	2 400	1,04
	113	160	160	38	51222	136 000	395 000	1 300	1 900	2,42
	113	190	187	63	51322X	282 000	755 000	900	1 300	7,19
	113	230	225	95	51422X	415 000	1 150 000	630	950	20
120	122	155	155	25	51124	90 000	310 000	1 600	2 400	1,12
	123	170	170	39	51224	141 000	430 000	1 200	1 800	2,7
	123	210	205	70	51324X	330 000	930 000	800	1 200	9,7
	123	250	245	102	51424X	480 000	1 400 000	600	900	26,2
130	132	170	170	30	51126	105 000	350 000	1 400	2 000	1,68
	133	190	187	45	51226X	183 000	550 000	1 100	1 600	3,95
	134	225	220	75	51326X	350 000	1 030 000	750	1 100	12,1
	134	270	265	110	51426X	525 000	1 590 000	530	800	32,3
140	142	180	178	31	51128X	107 000	375 000	1 300	2 000	1,83
	143	200	197	46	51228X	186 000	575 000	1 000	1 500	4,3
	144	240	235	80	51328X	370 000	1 130 000	670	1 000	14,2
	144	280	275	112	51428X	550 000	1 750 000	530	800	34,7
150	152	190	188	31	51130X	110 000	400 000	1 300	1 900	1,95
	153	215	212	50	51230X	238 000	735 000	950	1 400	5,52
	154	250	245	80	51330X	380 000	1 200 000	670	1 000	15
	154	300	295	120	51430X	620 000	2 010 000	480	710	43,5
160	162	200	198	31	51132X	113 000	425 000	1 200	1 900	2,07
	163	225	222	51	51232X	249 000	805 000	900	1 400	6,04
	164	270	265	87	51332X	475 000	1 570 000	600	900	19,6
	164	320	315	130	51432X	650 000	2 210 000	450	670	52,7
170	172	215	213	34	51134X	135 000	510 000	1 100	1 700	2,72
	173	240	237	55	51234X	280 000	915 000	850	1 300	7,41
	174	280	275	87	51334X	465 000	1 570 000	600	900	20,3
	174	340	335	135	51434X	715 000	2 480 000	430	630	61,2
180	183	225	222	34	51136X	136 000	530 000	1 100	1 700	2,79
	183	250	247	56	51236X	284 000	955 000	800	1 200	7,94
	184	300	295	95	51336X	480 000	1 680 000	560	850	25,9
	184	360	355	140	51436X	750 000	2 730 000	400	600	70,5
190	193	240	237	37	51138X	172 000	655 000	1 000	1 600	3,6
	194	270	267	62	51238X	320 000	1 110 000	750	1 100	11,8
	195	320	315	105	51338X	550 000	1 960 000	500	750	36,5

For all dimensions and specifications refer to Cat. RB/A/GB/... from page B203 to B229.

Thrust Bearings

Single-direction Thrust Ball Bearings, Bore Diameter 200 – 360 mm



Boundary Dimensions (mm)					Bearing Numbers	Basic Load Ratings (N)		Limiting Speeds (min ⁻¹)		Mass (kg) approx
<i>d</i>	<i>D_i</i>	<i>D</i>	<i>d_i</i>	<i>T</i>		With Flat Seat	<i>C_a</i>	<i>C_{0a}</i>	Grease	
200	203	250	247	37	51140X	173 000	675 000	1 000	1 500	3,75
	204	280	277	62	51240X	315 000	1 110 000	710	1 100	12,3
	205	340	335	110	51340X	600 000	2 220 000	480	710	43,6
220	223	270	267	37	51144X	179 000	740 000	950	1 500	4,09
	224	300	297	63	51244X	325 000	1 210 000	670	1 000	13,6
240	243	300	297	45	51148X	229 000	935 000	850	1 200	6,55
	244	340	335	78	51248X	420 000	1 650 000	560	850	23,7
260	263	320	317	45	51152X	233 000	990 000	800	1 200	7,01
	264	360	355	79	51252X	435 000	1 800 000	560	850	25,1
280	283	350	347	53	51156X	315 000	1 310 000	710	1 000	12
	284	380	375	80	51256X	450 000	1 950 000	530	800	27,1
300	304	380	376	62	51160X	360 000	1 560 000	600	900	17,2
	304	420	415	95	51260X	540 000	2 410 000	450	670	43,5
320	324	400	396	63	51164X	365 000	1 660 000	600	900	18,6
	325	440	435	95	51264X	585 000	2 680 000	450	670	45
340	344	420	416	64	51168X	375 000	1 760 000	560	850	19,9
	345	460	455	96	51268X	595 000	2 800 000	430	630	47,9
360	364	440	436	65	51172X	385 000	1 860 000	560	800	21,5
	365	500	495	110	51272X	705 000	3 500 000	380	560	68,8

For all dimensions and specifications refer to Cat. RB/A/GB/... from page B203 to B229.

Thrust Bearings (Inch)

Single-direction Thrust Ball Bearings, Bore Diameter $\frac{1}{4}$ – $2\frac{1}{8}$ Inch

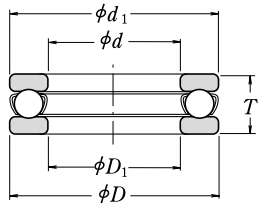

With Flat Seat

Boundary Dimensions (Inch)					Bearing Numbers	Basic Load Ratings (N)		Limiting Speeds (min ⁻¹)		Mass (kg) approx
d	D ₁	D	d ₁	T		C _a	C _{0a}	Grease	Oil	
$\frac{1}{4}$	$\frac{9}{32}$	$\frac{13}{16}$	$\frac{25}{32}$	$\frac{3}{8}$	LT $\frac{1}{4}$ B	6 550	7 760	9 600	14 500	0,014
$\frac{5}{16}$	$\frac{11}{32}$	1	$\frac{17}{32}$	$\frac{17}{32}$	LT $\frac{5}{16}$ B	8 900	11 200	7 900	12 000	0,043
$\frac{3}{8}$	$\frac{9}{32}$	1	$\frac{31}{32}$	$\frac{17}{32}$	LT $\frac{3}{8}$ B	8 900	11 200	7 900	12 000	0,043
$\frac{7}{16}$	$\frac{5}{32}$	$1\frac{1}{32}$	1 $\frac{1}{4}$	$\frac{5}{8}$	LT $\frac{7}{16}$ B	14 900	19 900	6 400	9 600	0,078
$\frac{1}{2}$	$\frac{17}{32}$	$1\frac{1}{32}$	1 $\frac{1}{4}$	$\frac{5}{8}$	LT $\frac{1}{2}$ B	19 200	25 100	6 400	9 600	0,074
$\frac{9}{16}$	$\frac{9}{32}$	$1\frac{1}{32}$	1 $\frac{3}{8}$	$\frac{5}{8}$	LT $\frac{9}{16}$ B	20 000	28 300	5 700	8 700	0,085
$\frac{5}{8}$	$2\frac{1}{32}$	$1\frac{1}{32}$	1 $\frac{3}{8}$	$\frac{5}{8}$	LT $\frac{5}{8}$ B	20 000	28 300	5 700	8 700	0,085
$\frac{3}{4}$	$2\frac{5}{32}$	$1\frac{1}{32}$	1 $\frac{1}{2}$	$\frac{5}{8}$	LT $\frac{3}{4}$ B	18 200	29 800	5 200	7 900	0,099
1	$1\frac{1}{32}$	$1\frac{25}{32}$	1 $\frac{3}{4}$	$\frac{5}{8}$	LT1B	19 300	29 800	4 600	7 000	0,113
	$1\frac{1}{8}$	2	1 $\frac{7}{8}$	$\frac{3}{4}$	MT1	27 300	46 600	4 300	6 600	0,17
1 $\frac{1}{8}$	$1\frac{1}{32}$	$1\frac{29}{32}$	1 $\frac{7}{8}$	$\frac{5}{8}$	LT1 $\frac{1}{8}$ B	20 500	39 700	4 200	6 400	0,122
	$1\frac{1}{4}$	2 $\frac{1}{4}$	2 $\frac{1}{8}$	$\frac{7}{8}$	MT1 $\frac{1}{8}$	34 100	55 900	3 900	5 900	0,248
1 $\frac{1}{4}$	1 $\frac{1}{4}$	2 $\frac{1}{16}$	2 $\frac{1}{16}$	$2\frac{3}{32}$	LT1 $\frac{1}{4}$ B	23 100	44 000	3 900	5 900	0,177
	$1\frac{3}{8}$	2 $\frac{1}{2}$	2 $\frac{3}{8}$	1	MT1 $\frac{1}{4}$	45 600	76 100	3 500	5 300	0,354
1 $\frac{3}{8}$	$1\frac{9}{32}$	2 $\frac{7}{32}$	2 $\frac{3}{16}$	$2\frac{3}{32}$	LT1 $\frac{3}{8}$ B	22 700	44 000	3 600	5 500	0,181
1 $\frac{1}{2}$	$1\frac{17}{32}$	2 $\frac{11}{32}$	2 $\frac{5}{16}$	$2\frac{3}{32}$	LT1 $\frac{1}{2}$ B	24 300	50 300	3 400	5 200	0,2
	$1\frac{5}{8}$	2 $\frac{7}{8}$	2 $\frac{3}{4}$	1 $\frac{1}{8}$	MT1 $\frac{1}{2}$	57 500	99 400	3 000	4 600	0,531
1 $\frac{5}{8}$	$1\frac{21}{32}$	2 $\frac{5}{32}$	2 $\frac{7}{16}$	$2\frac{3}{32}$	LT1 $\frac{5}{8}$ B	23 900	50 300	3 200	4 900	0,213
1 $\frac{3}{4}$	$1\frac{25}{32}$	2 $\frac{11}{16}$	2 $\frac{21}{32}$	$\frac{3}{4}$	LT1 $\frac{3}{4}$ B	35 400	75 100	3 000	4 500	0,276
	$1\frac{7}{8}$	3 $\frac{3}{16}$	3 $\frac{3}{16}$	1 $\frac{1}{4}$	MT1 $\frac{3}{4}$	84 500	154 000	2 600	4 000	0,744
1 $\frac{7}{8}$	$1\frac{29}{32}$	2 $\frac{9}{16}$	2 $\frac{25}{32}$	$\frac{3}{4}$	LT1 $\frac{7}{8}$ B	31 000	69 900	2 800	4 200	0,291
2	$2\frac{1}{32}$	3 $\frac{1}{32}$	2 $\frac{5}{16}$	$\frac{3}{4}$	LT2	33 600	81 500	2 600	4 000	0,304
	$2\frac{1}{32}$	3 $\frac{3}{16}$	3 $\frac{1}{32}$	$\frac{11}{16}$	XLT2	25 900	62 900	2 600	3 900	0,312
	$2\frac{1}{8}$	3 $\frac{11}{16}$	3 $\frac{5}{16}$	1 $\frac{3}{8}$	MT2	96 000	186 000	2 300	3 500	1,06
2 $\frac{1}{8}$	$2\frac{5}{32}$	3 $\frac{7}{16}$	3 $\frac{5}{32}$	$\frac{11}{16}$	XLT2 $\frac{1}{8}$	25 500	62 900	2 400	3 700	0,326
	$2\frac{3}{8}$	3 $\frac{1}{32}$	3 $\frac{3}{16}$	$\frac{7}{8}$	LT2 $\frac{1}{8}$	43 700	101 000	2 500	3 800	0,404

For all dimensions and specifications refer to Cat. RB/A/GB/... from page B203 to B229.

Thrust Bearings (Inch)

Single-direction Thrust Ball Bearings, Bore Diameter 2¼ – 3⅞ Inch



Boundary Dimensions (Inch)					Bearing Numbers	Basic Load Ratings (N)		Limiting Speeds (min ⁻¹)		Mass (kg) approx
<i>d</i>	<i>D</i> ₁	<i>D</i>	<i>d</i> ₁	<i>T</i>		<i>C</i> _a	<i>C</i> _{0a}	Grease	Oil	
2¼	2½ ₃₂	3⅝	3⅝ ₃₂	⅞ ₁₆	XLT2¼	26 800	69 200	2 300	3 500	0,34
	2½ ₃₂	3⅝ ₃₂	3⅝	⅞	LT2¼	43 100	101 000	2 400	3 600	0,454
	2½	4¼	4⅞	1⅞ ₁₆	MT2¼	128 000	246 000	2 000	3 100	1,75
2⅝	2⅞ ₃₂	3⅞	3⅞ ₃₂	⅞ ₁₆	XLT2⅝	26 500	69 200	2 200	3 400	0,354
	2⅞ ₃₂	3⅞ ₃₂	3⅞	1	LT2⅝	58 000	137 000	2 200	3 400	0,581
2½	2⅞ ₃₂	3⅞	3⅞ ₃₂	⅞ ₁₆	XLT2½	27 700	75 400	2 100	3 300	0,368
	2⅞ ₃₂	3⅞ ₃₂	3⅞	1	LT2½	57 500	137 000	2 100	3 200	0,64
	2⅞	4¼	4⅞	2	MT2½	160 000	304 000	1 800	2 800	2,78
2⅞	2⅞ ₃₂	3⅞	3⅞ ₃₂	¾	XLT2⅞	32 100	85 400	2 000	3 100	0,454
	2⅞ ₃₂	3⅞ ₃₂	3⅞	1	LT2⅞	57 000	137 000	2 000	3 100	0,64
2¾	2⅞ ₃₂	3⅞	3⅞ ₃₂	¾	XLT2¾	33 700	93 100	2 000	3 000	0,513
	2⅞ ₃₂	4⅞ ₃₂	4	1	LT2¾	56 500	137 000	2 000	3 000	0,68
	2⅞	5	4⅞	2	MT2¾	177 000	365 000	1 700	2 600	2,89
2⅞	2⅞ ₃₂	4	3⅞ ₃₂	¾	XLT2⅞	35 100	101 000	1 900	2 900	0,513
	2⅞ ₃₂	4⅞ ₃₂	4⅞	1	LT2⅞	64 000	157 000	1 900	2 900	0,708
3	3⅞ ₁₆	4⅞	4⅞ ₁₆	¾	XLT3	34 800	101 000	1 800	2 800	0,513
	3⅞ ₁₆	4⅞	4⅞ ₁₆	1⅞	LT3	72 500	179 000	1 800	2 700	0,948
	3⅞	5⅞	5½	2¼	MT3	226 000	477 000	1 500	2 300	4,14
3⅞	3⅞ ₁₆	4½	4⅞ ₁₆	1⅞	LT3⅞	87 000	224 000	1 700	2 600	0,953
3¼	3⅞ ₁₆	4⅞	4⅞ ₁₆	¾	XLT3¼	35 800	97 000	1 700	2 600	0,54
	3⅞ ₁₆	4⅞ ₁₆	4¾	1¼	LT3¼	90 500	226 000	1 600	2 400	1,29
3⅞	3⅞ ₁₆	4⅞ ₁₆	4⅞	1¼	LT3⅞	89 500	226 000	1 600	2 400	1,23
3½	3⅞ ₁₆	4⅞	4⅞ ₁₆	¾	XLT3½	36 800	116 000	1 600	2 400	0,567
	3⅞ ₁₆	5⅞ ₁₆	5	1¼	LT3½	88 500	226 000	1 500	2 300	1,39
	3⅞	6⅞ ₁₆	6⅞ ₁₆	2½	MT3½	274 000	616 000	1 300	1 900	5,81
3⅞	3⅞ ₁₆	5⅞ ₁₆	5⅞	1¼	LT3⅞	94 500	251 000	1 500	2 200	1,31
3¾	3⅞ ₁₆	4⅞	4⅞ ₁₆	¾	XLT3¾	37 700	124 000	1 500	2 200	0,5943
	3⅞ ₁₆	5⅞ ₁₆	5¼	1¼	LT3¾	93 500	251 000	1 400	2 100	1,36
3⅞	3⅞ ₁₆	5⅞ ₁₆	5⅞	1⅞	LT3⅞	107 000	308 000	1 300	2 000	1,741

For all dimensions and specifications refer to Cat. RB/A/GB/... from page B203 to B229.

Thrust Bearings (Inch)

Single-direction Thrust Ball Bearings, Bore Diameter 4 – 9½ Inch

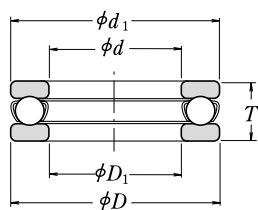

With Flat Seat

Boundary Dimensions (Inch)					Bearing Numbers	Basic Load Ratings (N)		Limiting Speeds (min ⁻¹)		Mass (kg) approx
d	D_1	D	d_1	T		With Flat Seat		Grease	Oil	
4	4 $\frac{1}{16}$	5 $\frac{1}{4}$	5 $\frac{3}{16}$	$\frac{7}{8}$	XLT4	49 500	156 000	1 400	2 100	0,866
	4 $\frac{1}{8}$	5 $\frac{5}{16}$	5 $\frac{1}{2}$	1 $\frac{1}{8}$	LT4	122 000	325 000	1 300	2 000	2
	4 $\frac{1}{4}$	7 $\frac{1}{4}$	7 $\frac{1}{8}$	2 $\frac{9}{16}$	MT4	305 000	745 000	1 100	1 700	7,98
4 $\frac{1}{4}$	4 $\frac{5}{16}$	6 $\frac{5}{16}$	6 $\frac{1}{4}$	1 $\frac{3}{4}$	LT4 $\frac{1}{4}$	153 000	403 000	1 200	1 800	2,89
4 $\frac{1}{2}$	4 $\frac{1}{8}$	5 $\frac{3}{4}$	5 $\frac{7}{16}$	1	XLT4 $\frac{1}{2}$	50 500	168 000	1 200	1 900	1,11
	4 $\frac{1}{4}$	6 $\frac{5}{16}$	6 $\frac{1}{2}$	1 $\frac{1}{4}$	LT4 $\frac{1}{2}$	150 000	402 000	1 100	1 700	3,13
	4 $\frac{3}{8}$	8 $\frac{3}{8}$	8 $\frac{1}{4}$	3 $\frac{3}{8}$	MT4 $\frac{1}{2}$	398 000	1 070 000	950	1 400	13,8
4 $\frac{3}{4}$	4 $\frac{9}{16}$	7 $\frac{1}{16}$	7	2	LT4 $\frac{3}{4}$	203 000	547 000	1 000	1 600	4,32
5	5 $\frac{1}{16}$	6 $\frac{1}{2}$	6 $\frac{1}{16}$	1 $\frac{1}{8}$	XLT5	67 000	228 000	1 100	1 600	1,67
	5 $\frac{1}{8}$	7 $\frac{1}{16}$	7 $\frac{1}{4}$	2	LT5	201 000	548 000	1 000	1 500	4,47
	5 $\frac{1}{4}$	9 $\frac{1}{2}$	9 $\frac{3}{8}$	4	MT5	473 000	1 340 000	850	1 300	21,2
5 $\frac{1}{2}$	5 $\frac{1}{8}$	7	6 $\frac{5}{16}$	1 $\frac{1}{8}$	XLT5 $\frac{1}{2}$	68 500	243 000	950	1 500	1,7
	5 $\frac{1}{4}$	8 $\frac{1}{16}$	8	2 $\frac{3}{16}$	LT5 $\frac{1}{2}$	258 000	715 000	900	1 300	5,99
	5 $\frac{3}{8}$	10 $\frac{3}{8}$	10 $\frac{1}{4}$	4 $\frac{1}{4}$	MT5 $\frac{1}{2}$	486 000	1 640 000	750	1 100	25,9
6	6 $\frac{1}{16}$	7 $\frac{3}{8}$	7 $\frac{1}{16}$	1 $\frac{1}{4}$	XLT6	88 000	318 000	900	1 300	2,21
	6 $\frac{1}{8}$	8 $\frac{1}{16}$	8 $\frac{3}{8}$	2 $\frac{3}{8}$	LT6	280 000	808 000	800	1 200	7,44
	6 $\frac{1}{4}$	11 $\frac{1}{8}$	11	4 $\frac{1}{2}$	MT6	564 000	1 750 000	650	1 000	31,3
6 $\frac{1}{2}$	6 $\frac{5}{16}$	8 $\frac{3}{8}$	8	1 $\frac{1}{4}$	XLT6 $\frac{1}{2}$	90 000	338 000	800	1 200	2,48
	6 $\frac{3}{8}$	9 $\frac{9}{32}$	9 $\frac{9}{32}$	2 $\frac{1}{2}$	LT6 $\frac{1}{2}$	312 000	956 000	750	1 100	9,3
7	7 $\frac{1}{8}$	8 $\frac{3}{4}$	8 $\frac{3}{8}$	1 $\frac{3}{8}$	XLT7	113 000	428 000	750	1 100	3,06
	7 $\frac{1}{4}$	10 $\frac{1}{8}$	10	2 $\frac{5}{8}$	LT7	346 000	1 120 000	650	1 000	10,7
	7 $\frac{1}{2}$	12 $\frac{3}{4}$	12 $\frac{3}{8}$	5	MT7	619 000	2 410 000	550	850	45,8
7 $\frac{1}{2}$	7 $\frac{3}{8}$	9 $\frac{1}{4}$	9 $\frac{3}{8}$	1 $\frac{3}{8}$	XLT7 $\frac{1}{2}$	115 000	453 000	700	1 000	3,23
	7 $\frac{1}{2}$	10 $\frac{1}{8}$	10 $\frac{3}{4}$	2 $\frac{3}{4}$	LT7 $\frac{1}{2}$	310 000	1 030 000	600	950	13,4
8	8 $\frac{1}{8}$	10	9 $\frac{3}{8}$	1 $\frac{1}{2}$	XLT8	135 000	528 000	600	950	4,25
	8 $\frac{1}{4}$	11 $\frac{1}{8}$	11 $\frac{1}{2}$	3	LT8	339 000	1 120 000	550	850	16,3
	8 $\frac{1}{2}$	14 $\frac{1}{8}$	14 $\frac{1}{4}$	5 $\frac{1}{8}$	MT8	713 000	2 480 000	470	700	64,4
8 $\frac{1}{2}$	8 $\frac{3}{8}$	10 $\frac{1}{2}$	10 $\frac{3}{8}$	1 $\frac{1}{2}$	XLT8 $\frac{1}{2}$	138 000	559 000	600	900	4,72
9	9 $\frac{1}{8}$	11 $\frac{1}{4}$	11 $\frac{1}{8}$	1 $\frac{1}{8}$	XLT9	136 000	760 000	550	800	6,94
	9 $\frac{1}{4}$	13 $\frac{1}{8}$	13	3 $\frac{1}{2}$	LT9	476 000	1 790 000	480	750	25,9
9 $\frac{1}{2}$	9 $\frac{3}{8}$	11 $\frac{3}{4}$	11 $\frac{1}{8}$	1 $\frac{1}{8}$	XLT9 $\frac{1}{2}$	196 000	805 000	500	750	7,26

For all dimensions and specifications refer to Cat. RB/A/GB/... from page B203 to B229.

Thrust Bearings (Inch)

Single-direction Thrust Ball Bearings, Bore Diameter 10 – 18 Inch



Boundary Dimensions (Inch)					Bearing Numbers	Basic Load Ratings (N)		Limiting Speeds (min ⁻¹)		Mass (kg) approx
<i>d</i>	<i>D_i</i>	<i>D</i>	<i>d_i</i>	<i>T</i>		<i>C_a</i>	<i>C_{0a}</i>	Grease	Oil	
10	10 $\frac{1}{8}$	12 $\frac{1}{2}$	12 $\frac{3}{8}$	2 $\frac{1}{8}$	XLT10	246 000	974 000	470	700	9,93
	10 $\frac{1}{8}$	14 $\frac{1}{8}$	14 $\frac{1}{2}$	4	LT10	559 000	2 190 000	410	600	36,2
10 $\frac{1}{2}$	10 $\frac{5}{8}$	13	12 $\frac{1}{2}$	2 $\frac{1}{8}$	XLT10 $\frac{1}{2}$	253 000	1 030 000	440	650	9,98
11	11 $\frac{1}{8}$	13 $\frac{3}{4}$	13 $\frac{3}{8}$	2 $\frac{3}{8}$	XLT11	275 000	1 100 000	410	600	13,4
	11 $\frac{1}{8}$	15 $\frac{1}{8}$	15 $\frac{3}{4}$	4 $\frac{1}{4}$	LT11	583 000	2 430 000	370	550	43,9
11 $\frac{1}{2}$	11 $\frac{5}{8}$	14 $\frac{1}{2}$	14 $\frac{1}{8}$	2 $\frac{3}{8}$	XLT11 $\frac{1}{2}$	284 000	1 120 000	390	600	14
12	12 $\frac{1}{8}$	15	14 $\frac{1}{2}$	2 $\frac{1}{2}$	XLT12	308 000	1 270 000	360	550	15,9
12 $\frac{1}{2}$	12 $\frac{1}{2}$	15 $\frac{1}{2}$	15 $\frac{1}{8}$	2 $\frac{1}{8}$	XLT12 $\frac{1}{2}$	317 000	1 340 000	340	500	18,6
13	13 $\frac{1}{8}$	16 $\frac{1}{4}$	16 $\frac{1}{8}$	2 $\frac{3}{4}$	XLT13	332 000	1 420 000	320	490	21,9
13 $\frac{1}{2}$	13 $\frac{1}{2}$	16 $\frac{3}{4}$	16 $\frac{1}{2}$	2 $\frac{1}{8}$	XLT13 $\frac{1}{2}$	363 000	1 600 000	310	470	22,5
14	14 $\frac{1}{8}$	17 $\frac{1}{2}$	17 $\frac{1}{8}$	3	XLT14	375 000	1 670 000	290	440	16,3
14 $\frac{1}{2}$	14 $\frac{1}{2}$	18	17 $\frac{1}{8}$	3 $\frac{1}{8}$	XLT14 $\frac{1}{2}$	408 000	1 860 000	280	420	28,4
15	15 $\frac{1}{4}$	18 $\frac{3}{4}$	18 $\frac{1}{2}$	3 $\frac{1}{4}$	XLT15	420 000	1 990 000	260	400	33,1
15 $\frac{1}{2}$	15 $\frac{3}{4}$	19 $\frac{1}{4}$	19	3 $\frac{1}{8}$	XLT15 $\frac{1}{2}$	434 000	2 050 000	250	380	35,8
16	16 $\frac{1}{4}$	20	19 $\frac{3}{4}$	3 $\frac{1}{2}$	XLT16	465 000	2 250 000	240	360	39,
16 $\frac{1}{2}$	16 $\frac{3}{4}$	20 $\frac{1}{2}$	20 $\frac{1}{4}$	3 $\frac{1}{8}$	XLT16 $\frac{1}{2}$	481 000	2 400 000	230	350	44,5
17	17 $\frac{1}{4}$	21 $\frac{1}{4}$	21	3 $\frac{3}{4}$	XLT17	513 000	2 610 000	220	330	49,9
17 $\frac{1}{2}$	17 $\frac{3}{4}$	21 $\frac{3}{4}$	21 $\frac{1}{2}$	3 $\frac{1}{8}$	XLT17 $\frac{1}{2}$	548 000	2 840 000	210	320	54
18	18 $\frac{1}{4}$	22 $\frac{1}{2}$	22 $\frac{1}{4}$	4	XLT18	543 000	2 860 000	200	310	59

For all dimensions and specifications refer to Cat. RB/A/GB/... from page B203 to B229.

Thrust Bearings

Double-direction Thrust Ball Bearings, Bore Diameter 10 – 65 mm

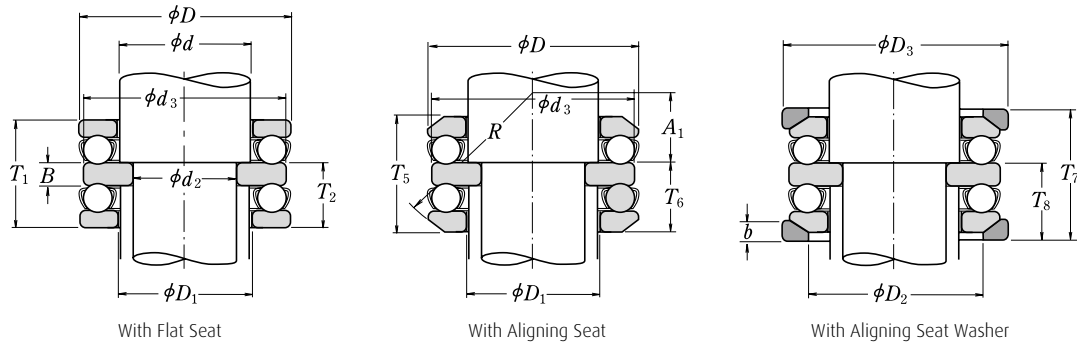

Boundary Dimensions (mm)					Bearing Numbers	Basic Load Ratings (N)		Limiting Speeds (min ⁻¹)		Mass (kg) approx
d_2	d	D_1	D	T_1		C_a	C_{0a}	Grease	Oil	
					With Flat Seat					
10	15	17	32	22	52202	16 700	24 800	4 800	7 100	0,081
15	20	22	40	26	52204	22 500	37 500	4 000	6 000	0,148
	25	27	60	45	52405	56 000	89 500	2 400	3 600	0,641
20	25	27	47	28	52205	28 000	50 500	3 400	5 300	0,213
	25	27	52	34	52305	36 000	61 500	3 000	4 500	0,324
	30	32	70	52	52406	73 000	126 000	2 200	3 200	0,978
25	30	32	52	29	52206	29 500	58 000	3 200	5 000	0,254
	30	32	60	38	52306	43 000	78 500	2 600	4 000	0,483
	35	37	80	59	52407	87 500	155 000	1 800	2 800	1,43
30	35	37	62	34	52207	39 500	78 000	2 800	4 300	0,406
	35	37	68	44	52307	56 000	105 000	2 400	3 600	0,71
	40	42	68	36	52208	47 500	98 500	2 600	3 800	0,543
	40	42	78	49	52308	70 000	135 000	2 000	3 000	1,04
	40	42	90	65	52408	103 000	188 000	1 700	2 400	1,98
35	45	47	73	37	52209	48 000	105 000	2 400	3 600	0,606
	45	47	85	52	52309	80 500	163 000	1 900	2 800	1,28
	45	47	100	72	52409	128 000	246 000	1 500	2 200	2,71
40	50	52	78	39	52210	49 000	111 000	2 400	3 400	0,697
	50	52	95	58	52310	97 500	202 000	1 700	2 600	1,78
	50	52	110	78	52410	147 000	288 000	1 400	2 000	3,51
45	55	57	90	45	52211	70 000	159 000	2 000	3 000	1,11
	55	57	105	64	52311	115 000	244 000	1 500	2 400	2,43
	55	57	120	87	52411	181 000	350 000	1 200	1 800	4,66
50	60	62	95	46	52212	71 500	169 000	1 900	3 000	1,22
	60	62	110	64	52312	119 000	263 000	1 500	2 200	2,59
	60	62	130	93	52412	202 000	395 000	1 100	1 700	5,74
	65	68	140	101	52413	234 000	495 000	1 000	1 600	7,41
55	65	67	100	47	52213	75 500	189 000	1 900	2 800	1,34
	65	67	115	65	52313	123 000	282 000	1 500	2 200	2,8
	70	72	105	47	52214	74 000	189 000	1 800	2 800	1,44
	70	72	125	72	52314	137 000	315 000	1 300	2 000	3,67
	70	73	150	107	52414	252 000	555 000	1 000	1 500	8,99
60	75	77	110	47	52215	78 000	209 000	1 800	2 600	1,54
	75	77	135	79	52315	159 000	365 000	1 200	1 800	4,74
	75	78	160	115	52415	254 000	560 000	900	1 400	10,8
65	80	82	115	48	52216	79 000	218 000	1 700	2 600	1,66
	80	82	140	79	52316	164 000	395 000	1 200	1 800	4,99
	80	83	170	120	52416	272 000	620 000	850	1 300	12,6
	85	88	180	128	52417X	310 000	755 000	800	1 200	15,4

For all dimensions and specifications refer to Cat. RB/A/GB/... from page B203 to B229.

Thrust Bearings

Double-direction Thrust Ball Bearings, Bore Diameter 70 – 190 mm



Boundary Dimensions (mm)					Bearing Numbers	Basic Load Ratings (N)		Limiting Speeds (min ⁻¹)		Mass (kg) approx
d_2	d	D_1	D	T_1		C_a	C_{0a}	Grease	Oil	
70	85	88	125	55	52217	96 000	264 000	1 500	2 200	2,26
	85	88	150	87	52317	207 000	490 000	1 100	1 600	6,38
	90	93	190	135	52418X	330 000	825 000	750	1 100	17,5
75	90	93	135	62	52218	114 000	310 000	1 400	2 000	3,09
	90	93	155	88	52318	214 000	525 000	1 100	1 600	6,79
80	100	103	210	150	52420X	370 000	985 000	670	1 000	26,8
85	100	103	150	67	52220	135 000	375 000	1 300	1 900	4,08
	100	103	170	97	52320	239 000	595 000	950	1 500	8,82
90	110	113	230	166	52422X	415 000	1 150 000	600	900	35,6
95	110	113	160	67	52222	136 000	395 000	1 200	1 800	4,39
	110	113	190	110	52322X	282 000	755 000	850	1 300	12,7
	120	123	250	177	52424X	515 000	1 540 000	560	850	47,6
100	120	123	170	68	52224	141 000	430 000	1 200	1 800	4,92
	120	123	210	123	52324X	330 000	930 000	750	1 100	17,6
	130	134	270	192	52426X	525 000	1 590 000	530	800	57,8
110	130	133	190	80	52226X	183 000	550 000	1 000	1 500	7,43
	130	134	225	130	52326X	350 000	1 030 000	710	1 100	21,5
	140	144	280	196	52428X	550 000	1 750 000	500	750	62,4
120	140	143	200	81	52228X	186 000	575 000	1 000	1 500	8,01
	140	144	240	140	52328X	370 000	1 130 000	670	1 000	24,8
	150	153	300	209	52430X	620 000	2 010 000	480	710	77,8
130	150	153	215	89	52230X	238 000	735 000	900	1 300	10,4
	150	154	250	140	52330X	380 000	1 200 000	630	950	30,3
	160	164	320	226	52432X	650 000	2 210 000	430	630	93,6
135	170	174	340	236	52434X	715 000	2 480 000	400	600	110
140	160	163	225	90	52232X	249 000	805 000	850	1 300	11,2
	160	164	270	153	52332X	475 000	1 570 000	600	900	35,1
	180	184	360	245	52436X	750 000	2 730 000	380	560	126
150	170	173	240	97	52234X	280 000	915 000	800	1 200	13,6
	170	174	280	153	52334X	465 000	1 570 000	560	850	40,8
	180	183	250	98	52236X	284 000	955 000	800	1 200	14,8
	180	184	300	165	52336X	480 000	1 680 000	530	800	46,3
160	190	194	270	109	52238X	320 000	1 110 000	710	1 100	22,1
	190	195	320	183	52338X	550 000	1 960 000	480	710	113
170	200	204	280	109	52240X	315 000	1 110 000	710	1 000	23,1
	200	205	340	192	52340X	600 000	2 220 000	450	670	78,4
190	220	224	300	110	52244X	325 000	1 210 000	670	1 000	25,2

For all dimensions and specifications refer to Cat. RB/A/GB/... from page B203 to B229.

Thrust Bearings

Spherical Thrust Roller Bearings, Bore Diameter 60 – 240 mm

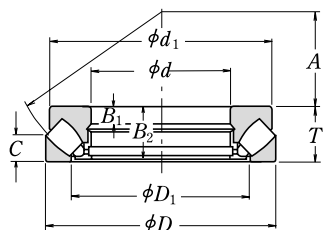

Boundary Dimensions (mm)					Bearing Numbers	Basic Load Ratings (N)		Limiting Speeds (min ⁻¹)	Mass (kg)
d	D ₁	D	d ₁	T		C _a	C _{0a}		
					With Flat Seat			Oil	approx
60	89	130	114,5	42	29412E	330 000	885 000	2 600	2,55
65	93	140	121,5	45	29413E	405 000	1 100 000	2 400	3,2
70	102	150	131,5	48	29414E	450 000	1 240 000	2 400	3,9
75	107	160	138	51	29415E	515 000	1 430 000	2 200	4,65
80	114,5	170	148	54	29416E	575 000	1 600 000	2 000	5,55
85	112	150	134,5	39	29317E	330 000	1 040 000	2 400	2,7
	124	180	156,5	58	29417E	630 000	1 760 000	1 900	6,55
90	118	155	139,5	39	29318E	350 000	1 080 000	2 200	2,83
	129,5	190	165,5	60	29418E	695 000	1 950 000	1 800	7,55
100	128	170	152	42	29320E	410 000	1 280 000	2 000	3,6
	144	210	185	67	29420E	840 000	2 400 000	1 600	10,3
110	142,5	190	169,5	48	29322E	530 000	1 710 000	1 800	5,25
	157	230	200	73	29422E	1 010 000	2 930 000	1 500	13,3
120	156,5	210	187,5	54	29324E	645 000	2 100 000	1 600	7,3
	171	250	215	78	29424E	1 160 000	3 400 000	1 400	16,6
130	168,5	225	203,5	58	29326E	740 000	2 450 000	1 500	8,95
	185	270	235	85	29426E	1 330 000	3 900 000	1 200	21,1
140	179	240	216,5	60	29328E	840 000	2 810 000	1 400	10,4
	195,5	280	244,5	85	29428E	1 370 000	4 200 000	1 200	22,2
150	190	250	224	60	29330E	870 000	2 900 000	1 400	10,8
	209	300	266	90	29430E	1 580 000	4 900 000	1 100	27,3
160	203	270	243	67	29332E	1 010 000	3 400 000	1 300	14,3
	224,5	320	278	95	29432E	1 740 000	5 400 000	1 100	32,1
170	214,5	280	252	67	29334E	1 050 000	3 500 000	1 200	14,8
	243	340	310	103	29434	1 680 000	5 800 000	1 000	43,5
180	227	300	270	73	29336E	1 230 000	4 200 000	1 100	19
	255	360	330	109	29436	1 870 000	6 500 000	900	52
190	244	320	288,5	78	29338E	1 370 000	4 700 000	1 100	23
	271	380	345	115	29438	2 100 000	7 450 000	850	60
200	236	280	266	48	29240	540 000	2 310 000	1 500	8,55
	257	340	306,5	85	29340E	1 570 000	5 450 000	1 000	28,5
	280	400	365	122	29440	2 290 000	8 150 000	800	69
220	254	300	285	48	29244	560 000	2 500 000	1 400	9,2
	280	360	335	85	29344	1 340 000	5 200 000	950	33
	308	420	385	122	29444	2 350 000	8 650 000	800	74
240	283	340	325	60	29248	800 000	3 450 000	1 200	16,5
	300	380	355	85	29348	1 360 000	5 400 000	950	35,5
	326	440	405	122	29448	2 420 000	9 100 000	750	79

For all dimensions and specifications refer to Cat. RB/A/GB/... from page B203 to B229.

Thrust Bearings

Spherical Thrust Roller Bearings, Bore Diameter 260 – 500 mm



Boundary Dimensions (mm)					Bearing Numbers	Basic Load Ratings (N)		Limiting Speeds (min ⁻¹)	Mass (kg)
<i>d</i>	<i>D</i> ₁	<i>D</i>	<i>d</i> ₁	<i>T</i>		With Flat Seat			
						<i>C</i> _a	<i>C</i> _{0a}	Oil	approx
260	302	360	345	60	29252	855 000	3 850 000	1 200	18
	329	420	390	95	29352	1 700 000	6 800 000	800	48,5
	357	480	445	132	29452	2 820 000	10 700 000	710	105
280	323	380	365	60	29256	885 000	4 100 000	1 100	19
	348	440	410	95	29356	1 830 000	7 650 000	800	52,5
	384	520	480	145	29456	3 400 000	13 100 000	630	132
300	353	420	400	73	29260	1 160 000	5 150 000	950	30
	379	480	450	109	29360	2 190 000	9 100 000	710	74
	402	540	500	145	29460	3 500 000	13 700 000	630	140
320	372	440	420	73	29264	1 190 000	5 450 000	950	32,5
	399	500	470	109	29364	2 230 000	9 400 000	670	77
	436	580	555	155	29464	3 650 000	14 600 000	560	175
340	395	460	440	73	29268	1 230 000	5 750 000	900	33,5
	428	540	510	122	29368	2 640 000	11 200 000	630	103
	462	620	590	170	29468	4 400 000	17 400 000	530	218
360	423	500	480	85	29272	1 550 000	7 300 000	800	51
	448	560	525	122	29372	2 670 000	11 500 000	600	107
	480	640	610	170	29472	4 200 000	17 200 000	500	228
380	441	520	496	85	29276	1 620 000	7 800 000	800	52
	477	600	568	132	29376	3 300 000	14 500 000	560	140
	504	670	640	175	29476	4 800 000	19 500 000	480	254
400	460	540	517	85	29280	1 640 000	8 000 000	750	55
	494	620	590	132	29380	3 250 000	14 500 000	530	150
	536	710	680	185	29480	5 400 000	22 100 000	450	306
420	489	580	553	95	29284	2 010 000	9 800 000	670	72
	520	650	620	140	29384	3 500 000	15 700 000	500	170
	556	730	700	185	29484	5 650 000	23 500 000	450	323
440	508	600	575	95	29288	2 030 000	10 100 000	670	77
	548	680	645	145	29388	3 750 000	16 700 000	480	190
	588	780	745	206	29488	6 550 000	27 200 000	400	407
460	530	620	592	95	29292	2 060 000	10 300 000	670	80
	567	710	666	150	29392	4 100 000	18 400 000	450	210
	608	800	765	206	29492	6 750 000	28 600 000	380	420
480	556	650	624	103	29296	2 370 000	12 100 000	600	97
	590	730	690	150	29396	4 150 000	19 000 000	450	215
	638	850	810	224	29496	7 200 000	31 000 000	360	545
500	574	670	645	103	292/500	2 390 000	12 400 000	600	100
	611	750	715	150	293/500	4 350 000	20 400 000	450	220
	661	870	830	224	294/500	7 850 000	33 000 000	340	560

For all dimensions and specifications refer to Cat. RB/A/GB/... from page B203 to B229.

Accessories

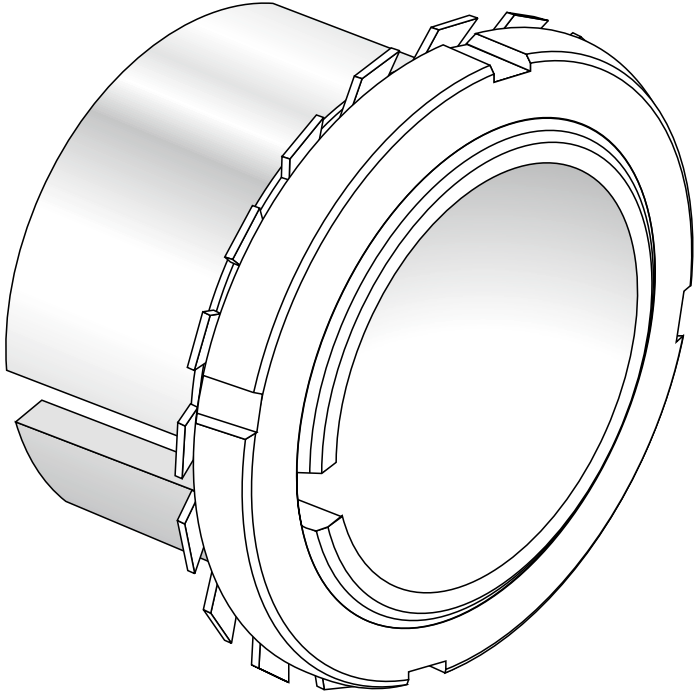

Sleeves, Locknuts and Washers

Sleeve Cross Reference Table

Bearings	Sleeves					
	H200	H300	H2300	H3000	H3100	H3200
Rigid Radial Ball Bearings	6211K to 6222K	6311K to 6322K	-	6224K to 6240K	6324K to 6340K	-
Double Row Self-aligning Ball Bearings	1204K to 1222K	1304K to 1322K	2304K to 2322K	-	-	-
		2204K to 2222K				
Spherical Roller Bearings	-	22205K to 22222K	23218K to 23256K	23024K to 230 / 500K	23122K to 230 / 500K	23260K to 232 / 500K
		21304K to 21322K	22308K to 22356K		22224K to 22264K	
Cylindrical Roller Bearings	N206K to N222K	NU2205K to NU2222K	NU2305K to NU2356K	N224K to N264K	NU2224K to NU2264K	-
	NU204K to NU222K	N306K to N322K		NU224K to NU264K	N324K to N340K	
		NU304K to NU322K		N344K to N356K	NU324K to NU340K	
				NU344K to NU356K		

Sleeves, Locknuts and Washers

Series H200/H300 (Metric), Series HE200/HE300/HS200/HS300/HA200 (Inch)

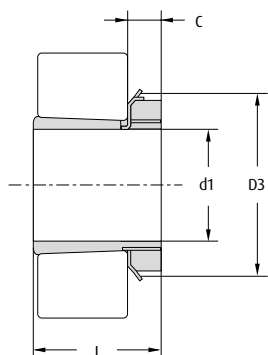

Sleeve	D1				L (mm)	D3 (mm)	C (mm)	Mass (kg)	Nut	Lock Washer
	H (mm)	HE (Inch)	HS (Inch)	HA (Inch)						
H204	17	-	-	-	24	32	7	0,041	KM 04	MB 04
H205	20	3/4	7/8	-	26	38	8	0,070	KM 05	MB 05
H206	25	1	7/8	1 1/16	27	45	8	0,099	KM 06	MB 06
H207	30	-	1 1/8	1 3/16	29	52	9	0,125	KM 07	MB 07
H208	35	1 1/4	1 3/8	1 3/8	31	58	10	0,174	KM 08	MB 08
H209	40	1 1/2	1 5/8	1 7/16	33	65	11	0,227	KM 09	MB 09
H210	45	1 3/4	1 7/8	1 7/16	35	70	12	0,274	KM 10	MB 10
H211	50	2	1 7/8	1 5/8	37	75	12	0,308	KM 11	MB 11
H212	55	-	2 1/8	-	38	80	13	0,346	KM 12	MB 12
H213	60	2 1/4	2 3/8	2 3/16	40	85	14	0,401	KM 13	MB 13
H215	65	2 1/2	-	2 3/16	43	98	15	0,707	KM 15	MB 15
H216	70	2 3/4	-	2 1/16	46	105	17	0,882	KM 16	MB 16
H217	75	3	-	2 5/16	50	110	18	1,020	KM 17	MB 17
H218	80	-	-	3 3/16	52	120	18	1,190	KM 18	MB 18
H219	85	3 1/4	-	-	55	125	19	1,370	KM 19	MB 19
H220	90	3 1/2	-	3 7/16	58	130	20	1,490	KM 20	MB 20
H222	100	4	-	3 5/16	63	145	21	1,930	KM 22	MB 22
H304	17	-	-	-	28	32	7	0,045	KM 04	MB 04
H305	20	3/4	7/8	-	29	38	8	0,075	KM 05	MB 05
H306	25	1	7/8	1 1/16	31	45	8	0,109	KM 06	MB 06
H307	30	-	1 1/8	1 3/16	35	52	9	0,142	KM 07	MB 07
H308	35	1 1/4	1 3/8	1 3/8	36	58	10	0,189	KM 08	MB 08
H309	40	1 1/2	1 5/8	1 7/16	39	65	11	0,248	KM 09	MB 09
H310	45	1 3/4	1 7/8	1 7/16	42	70	12	0,303	KM 10	MB 10
H311	50	2 1/2	1 7/8	1 5/8	45	75	12	0,345	KM 11	MB 11
H312	55	2 3/4	2 1/8	-	47	80	13	0,394	KM 12	MB 12
H313	60	3	2 3/8	2 3/16	50	85	14	0,458	KM 13	MB 13
H315	65	3 1/4	-	2 7/16	55	98	15	0,831	KM 15	MB 15
H316	70	3 1/2	-	2 1/16	59	105	17	1,030	KM 16	MB 16
H317	75	-	-	2 5/16	63	110	18	1,180	KM 17	MB 17
H318	80	-	-	3 3/16	65	120	18	1,370	KM 18	MB 18
H319	85	-	-	-	68	125	19	1,560	KM 19	MB 19
H320	90	-	-	3 7/16	71	130	20	1,690	KM 20	MB 20
H322	100	4	-	3 5/16	77	145	21	2,180	KM 22	MB 22

The reference for the sleeve includes the nut and the lock washer.

Sleeves, Locknuts and Washers

Series H2300 (Metric), Series HE2300/HS2300/HA2300 (Inch)

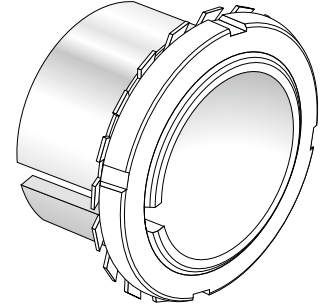

Sleeve	D1				L (mm)	D3 (mm)	C (mm)	Mass (kg)	Nut	Lock Washer
	H (mm)	HE (Inch)	HS (Inch)	HA (Inch)						
H2304	17	-	-	-	31	32	7	0,049	KM 04	MB 04
H2305	20	¾	-	-	35	38	8	0,087	KM 05	MB 05
H2306	25	1	-	-	38	45	8	0,126	KM 06	MB 06
H2307	30	-	-	-	43	52	9	0,165	KM 07	MB 07
H2308	35	1¼	1⅜	-	46	58	10	0,224	KM 08	MB 08
H2309	40	1½	-	1⅞	50	65	11	0,280	KM 09	MB 09
H2310	45	1¾	1⅞	1⅞	55	70	12	0,362	KM 10	MB 10
H2311	50	2	1⅞	1⅞	59	75	12	0,420	KM 11	MB 11
H2312	55	-	2⅞	-	62	80	13	0,481	KM 12	MB 12
H2313	60	2¼	2⅞	2⅞	65	85	14	0,557	KM 13	MB 13
H2315	65	2½	-	2⅞	73	98	15	1,050	KM 15	MB 15
H2316	70	2¾	-	2⅞	78	105	17	1,280	KM 16	MB 16
H2317	75	3	-	2⅞	82	110	18	1,450	KM 17	MB 17
H2318	80	-	-	3⅞	86	120	18	1,690	KM 18	MB 18
H2319	85	3¼	-	-	90	125	19	1,920	KM 19	MB 19
H2320	90	3½	-	3⅞	97	130	20	2,150	KM 20	MB 20
H2322	100	4	-	3⅞	105	145	21	2,740	KM 22	MB 22
H2324	110	4¼	-	4⅞	112	155	22	3,190	KM 24	MB 24
H2326	115	4½	-	4⅞	121	165	23	4,600	KM 26	MB 26
H2328	125	5	-	4⅞	131	180	24	5,550	KM 28	MB 28
H2330	135	5¼	-	5⅞	139	195	26	6,630	KM 30	MB 30
H2332	140	5½	-	5⅞	147	210	28	9,140	KM 32	MB 32
H2334	150	6	-	5⅞	154	220	29	10,200	KM 34	MB 34
H2336	160	6½	-	6⅞	161	230	30	11,300	KM 36	MB 36
H2338	170	6¾	-	6⅞	169	240	31	12,600	KM 38	MB 38
H2340	180	7	-	7⅞	176	250	32	13,900	KM 40	MB 40
H2344	200	-	-	-	183	280	35	16,700	HM 44 T	MB 44
H2348	220	-	-	-	199	300	37	19,700	HM 48 T	MB 48
H2352	240	-	-	-	208	330	39	24,200	HM 52 T	MB 52
H2356	260	-	-	-	221	350	41	27,800	HM 56 T	MB 56

The reference for the sleeve includes the nut and the lock washer.

Sleeves, Locknuts and Washers

Series H3000/H3100/H3200 (Metric), Series HE3100/HA3100 (Inch)

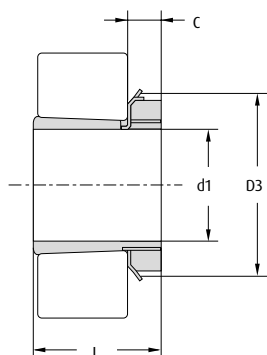

Sleeve	D1		L (mm)	D3 (mm)	C (mm)	Mass (kg)	Nut	Lock Washer	
	H (mm)	HE (Inch)							HA (Inch)
H3024	110	-	-	72	145	22	1,930	KML 24	MBL 24
H3026	115	-	-	80	155	23	2,850	KML 26	MBL 26
H3028	125	-	-	82	165	24	3,160	KML 28	MBL 28
H3030	135	-	-	87	180	26	3,890	KML 30	MBL 30
H3032	140	-	-	93	190	28	5,210	KML 32	MBL 32
H3034	150	-	-	101	200	29	5,990	KML 34	MBL 34
H3036	160	-	-	109	210	30	6,830	KML 36	MBL 36
H3038	170	-	-	112	220	31	7,450	KML 38	MBL 38
H3040	180	-	-	120	240	32	9,190	KML 40	MBL 40
H3044X	200	-	-	126	260	30	10,300	HM 3044	MS 3044
H3048	220	-	-	133	290	34	13,200	HM 3048	MS 3048
H3052X	240	-	-	145	310	34	15,300	HM 3052	MS 3052
H3056	260	-	-	152	330	38	17,700	HM 3056	MS 3056
H3060	280	-	-	168	360	42	22,800	HM 3060	MS 3060
H3064	300	-	-	171	380	42	24,600	HM 3064	MS 3064
H3124	110	4¼	4¾	88	155	22	2,640	KM 24	MB 24
H3126	115	4½	4¾	92	165	23	3,660	KM 26	MB 26
H3128	125	5	4¾	97	180	24	4,340	KM 28	MB 28
H3130	135	5¼	5¾	111	195	26	5,520	KM 30	MB 30
H3132	140	5½	5¾	119	210	28	7,670	KM 32	MB 32
H3134	150	6	5¾	122	220	29	8,380	KM 34	MB 34
H3136	160	6½	6¾	131	230	30	9,500	KM 36	MB 36
H3138	170	6¾	6¾	141	240	31	10,800	KM 38	MB 38
H3140	180	7	7¾	150	250	32	12,100	KM 40	MB 40
H3144	200	-	7¾	161	280	35	14,700	HM 44 T	MB 44
H3148	220	-	-	172	300	37	17,300	HM 48 T	MB 48
H3152	240	-	-	190	330	39	22,000	HM 52 T	MB 52
H3156	260	-	-	195	350	41	24,500	HM 56 T	MB 56
H3160	280	-	-	208	380	40	30,200	HM 3160	MS 3160
H3164	300	-	-	226	400	42	34,900	HM 3164	MS 3164
H3168	320	-	-	254	440	55	49,500	HM 3168	MS 3168
H3172	340	-	-	259	460	58	54,200	HM 3172	MS 3172
H3176	360	-	-	264	490	60	61,700	HM 3176	MS 3176
H3180	380	-	-	272	520	62	70,600	HM 3180	MS 3180
H3184	400	-	-	304	540	70	84,200	HM 3184	MS 3184
H3260	280	-	-	240	380	40	34,100	HM 3160	MS 3160
H3264	300	-	-	258	400	42	39,300	HM 3164	MS 3164
H3268	320	-	-	288	440	55	54,600	HM 3168	MS 3168
H3272	340	-	-	299	460	58	60,600	HM 3172	MS 3172
H3276	360	-	-	310	490	60	69,600	HM 3176	MS 3176
H3280	380	-	-	328	520	62	81,000	HM 3180	MS 3180

The reference for the sleeve includes the nut and the lock washer.

Withdrawal Sleeves

AH, AHX 300 and AH, AHX 2300 Series

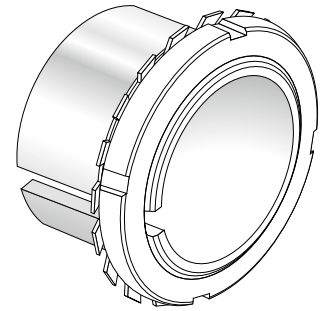
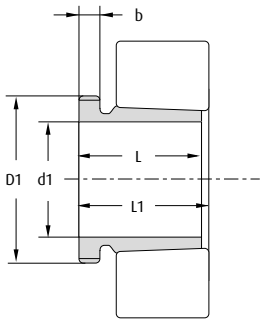

Sleeve	d1 (mm)	D1 (mm)	L (mm)	L1 (mm)	b (mm)	Mass (kg)	Thread	Nut
AH 308	35	45	29	32	6	0,090	M 45 x 1,5	KM 09
AH 309	40	50	31	34	6	0,109	M 50 x 1,5	KM 10
AHX 310	45	55	35	38	7	0,137	M 55 x 2,0	KM 11
AHX 311	50	60	37	40	7	0,161	M 60 x 2,0	KM 12
AHX 312	55	65	40	43	8	0,189	M 65 x 2,0	KM 13
AHX 313	60	75	42	45	8	0,253	M 75 x 2,0	KM 15
AH 314	65	80	43	47	8	0,280	M 80 x 2,0	KM 16
AH 315	70	85	45	49	8	0,313	M 85 x 2,0	KM 17
AH 316	75	90	48	52	8	0,365	M 90 x 2,0	KM 18
AHX 317	80	95	52	56	9	0,429	M 95 x 2,0	KM 19
AHX 318	85	100	53	57	9	0,461	M 100 x 2,0	KM 20
AHX 319	90	105	57	61	10	0,532	M 105 x 2,0	KM 21
AHX 320	95	110	59	63	10	0,582	M 110 x 2,0	KM 22
AH 2308	35	45	40	43	7	0,128	M 45 x 1,5	KM 09
AH 2309	40	50	44	47	7	0,164	M 50 x 1,5	KM 10
AHX 2310	45	55	50	53	9	0,209	M 55 x 2,0	KM 11
AHX 2311	50	60	54	57	10	0,253	M 60 x 2,0	KM 12
AHX 2312	55	65	58	61	11	0,297	M 65 x 2,0	KM 13
AHX 2313	60	75	61	64	12	0,395	M 75 x 2,0	KM 15
AHX 2314	65	80	64	68	12	0,466	M 80 x 2,0	KM 16
AHX 2315	70	85	68	72	12	0,534	M 85 x 2,0	KM 17
AHX 2316	75	90	71	75	12	0,597	M 90 x 2,0	KM 18
AHX 2317	80	95	74	78	13	0,670	M 95 x 2,0	KM 19
AHX 2318	85	100	79	83	14	0,779	M 100 x 2,0	KM 20
AHX 2319	90	105	85	89	16	0,886	M 105 x 2,0	KM 21
AHX 2320	95	110	90	94	16	0,998	M 110 x 2,0	KM 22
AHX 2322	105	125	98	102	16	1,350	M 125 x 2,0	KM 25
AHX 2324	115	135	105	109	17	1,600	M 135 x 2,0	KM 27
AHX 2326	125	145	115	119	19	1,970	M 145 x 2,0	KM 29
AHX 2328	135	155	125	130	20	2,330	M 155 x 3,0	KM 31
AHX 2330	145	165	135	140	24	2,820	M 165 x 3,0	KM 33
AH 2332	150	180	140	146	24	4,720	M 180 x 3,0	KM 36
AH 2334	160	190	146	152	24	5,250	M 190 x 3,0	KM 38
AH 2336	170	200	154	160	26	5,830	M 200 x 3,0	KM 40
AH 2338	180	210	160	167	26	6,630	MTr 210 x 4,0	HM 42 T
AH 2340	190	220	170	177	30	7,540	MTr 220 x 4,0	HM 44 T
AH 2344	200	240	181	189	30	13,500	MTr 240 x 4,0	HM 48 T

Withdrawal Sleeves

AH, AHX 300 and AH, AHX 2300 Series

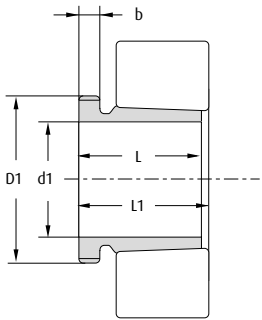

Sleeve	d1 (mm)	D1 (mm)	L (mm)	L1 (mm)	b (mm)	Mass (kg)	Thread	Nut
AH 2348	220	260	189	197	30	15,500	MTr 260 x 4,0	HM 52 T
AH 2352	240	290	205	213	30	19,600	MTr 290 x 4,0	HM 58 T
AH 2356	260	310	212	220	30	21,600	MTr 310 x 5,0	HM 62 T
AHX 3122	105	120	68	72	11	0,760	M 120 x 2	KM 24
AHX 3124	115	130	75	79	12	0,950	M 130 x 2	KM 26
AHX 3126	125	140	78	82	12	1,080	M 140 x 2	KM 28
AHX 3128	135	150	83	88	14	1,280	M 150 x 2	KM 30
AHX 3130	145	165	96	101	15	1,790	M 165 x 3	KM 33
AHX 3132	150	180	103	108	16	3,210	M 180 x 3	KM 36
AH 3134	160	190	104	109	16	3,400	M 190 x 3	KM 38
AH 3136	170	200	116	122	19	4,220	M 200 x 3	KM 40
AH 3138	180	210	125	131	20	4,890	MTr 210 x 4	HM 42 T
AH 3140	190	220	134	140	21	5,490	MTr 220 x 4	HM 44 T
AH 3144	200	240	145	151	23	10,400	MTr 240 x 4	HM 48 T
AH 3148	220	260	154	161	25	12,000	MTr 260 x 4	HM 52 T
AH 3152	240	290	172	179	26	16,200	MTr 290 x 4	HM 58 T
AH 3156	260	310	175	183	28	17,500	MTr 310 x 5	HM 62 T
AH 3160	280	330	192	200	30	20,800	MTr 330 x 5	HM 66 T
AH 3164	300	350	209	217	31	24,500	MTr 350 x 5	HM 70 T
AH 3168	320	370	225	234	33	29,000	MTr 370 x 5	HM 74 T
AH 3172	340	400	229	238	35	33,000	MTr 400 x 5	HM 80 T
AH 3176	360	420	232	242	36	35,700	MTr 420 x 5	HM 84 T
AH 3180	380	440	240	250	38	39,500	MTr 440 x 5	HM 88 T
AH 3184	400	460	266	276	40	46,500	MTr 460 x 5	HM 92 T
AHX 3218	85	100	63	67	10	0,576	M 100 x 2	KM 20
AHX 3220	95	110	73	77	11	0,767	M 110 x 2	KM 22
AHX 3222	105	125	82	86	11	1,040	M 125 x 2	KM 25
AHX 3224	115	135	90	94	13	1,300	M 135 x 2	KM 27
AHX 3226	125	145	98	102	15	1,580	M 145 x 2	KM 29
AHX 3228	135	155	104	109	15	1,840	M 155 x 3	KM 31
AHX 3230	145	165	114	119	17	2,220	M 165 x 3	KM 33
AH 3232	150	180	124	130	20	4,080	M 180 x 3	KM 36
AH 3234	160	190	134	140	24	4,800	M 190 x 3	KM 38
AH 3236	170	200	140	146	25	5,320	M 200 x 3	KM 40
AH 3238	180	210	145	152	25	5,900	MTr 210 x 4	HM 42 T
AH 3240	190	220	153	160	34	6,680	MTr 220 x 4	HM 44 T

Locknuts

KM Series

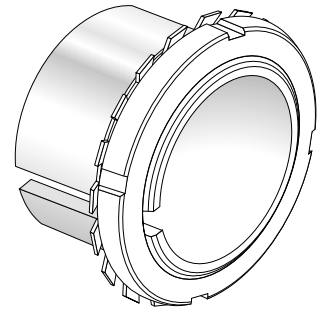
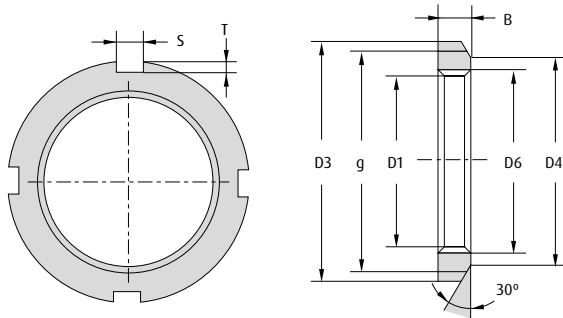

Nut	D3	D4	g	Thread	B	S	Thread	D6	Washer
KM 00	18	13,5	14	M 10 x 0,75	4	3	2	0,004	MB 00
KM 01	22	17	18	M 12 x 1,0	4	3	2	0,007	MB 01
KM 02	25	21	21	M 15 x 1,0	5	4	2	0,010	MB 02
KM 03	28	24	24	M 17 x 1,0	5	4	2	0,013	MB 03
KM 04	32	26	28	M 20 x 1,0	6	4	2	0,019	MB 04
KM 05	38	32	34	M 25 x 1,5	7	5	2	0,025	MB 05
KM 06	45	38	41	M 30 x 1,5	7	5	2	0,043	MB 06
KM 07	52	44	48	M 35 x 1,5	8	5	2	0,053	MB 07
KM 08	58	50	53	M 40 x 1,5	9	6	2,5	0,085	MB 08
KM 09	65	56	60	M 45 x 1,5	10	6	2,5	0,119	MB 09
KM 10	70	61	65	M 50 x 1,5	11	6	2,5	0,148	MB 10
KM 11	75	67	69	M 55 x 2,0	11	7	3	0,158	MB 11
KM 12	80	73	74	M 60 x 2,0	11	7	3	0,174	MB 12
KM 13	85	79	79	M 65 x 2,0	12	7	3	0,203	MB 13
KM 14	92	85	85	M 70 x 2,0	12	8	3,5	0,242	MB 14
KM 15	98	90	91	M 75 x 2,0	13	8	3,5	0,287	MB 15
KM 16	105	95	98	M 80 x 2,0	15	8	3,5	0,397	MB 16
KM 17	110	102	103	M 85 x 2,0	16	8	3,5	0,451	MB 17
KM 18	120	108	112	M 90 x 2,0	16	10	4	0,556	MB 18
KM 19	125	113	117	M 95 x 2,0	17	10	4	0,658	MB 19
KM 20	130	120	122	M 100 x 2,0	18	10	4	0,698	MB 20
KM 21	140	126	130	M 105 x 2,0	18	12	5	0,845	MB 21
KM 22	145	133	135	M 110 x 2,0	19	12	5	0,965	MB 22
KM 23	150	137	140	M 115 x 2,0	19	12	5	1,010	MB 23
KM 24	155	138	145	M 120 x 2,0	20	12	5	1,080	MB 24
KM 25	160	148	150	M 125 x 2,0	21	12	5	1,190	MB 25
KM 26	165	149	155	M 130 x 2,0	21	12	5	1,250	MB 26
KM 27	175	160	163	M 135 x 2,0	22	14	6	1,550	MB 27
KM 28	180	160	168	M 140 x 2,0	22	14	6	1,560	MB 28
KM 29	190	171	178	M 145 x 2,0	24	14	6	1,800	MB 29
KM 30	195	171	183	M 150 x 2,0	24	14	6	2,030	MB 30
KM 31	200	182	186	M 155 x 3,0	25	16	7	2,300	MB 31
KM 32	210	182	196	M 160 x 3,0	25	16	7	2,590	MB 32
KM 33	210	193	196	M 165 x 3,0	26	16	7	2,700	MB 33
KM 34	220	193	206	M 170 x 3,0	26	16	7	2,800	MB 34
KM 36	230	203	214	M 180 x 3,0	27	18	8	3,070	MB 36
KM 38	240	214	224	M 190 x 3,0	28	18	8	3,390	MB 38
KM 40	250	226	234	M 200 x 3,0	29	18	8	3,690	MB 40

Lock Washer

MB Series

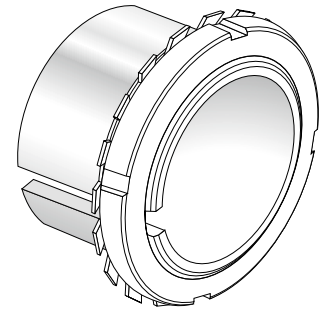
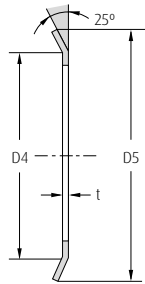
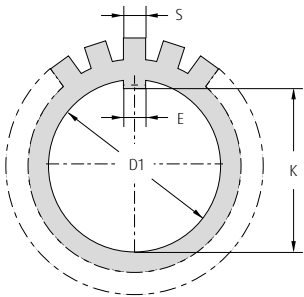

Washer	D1	K	E	t	S	D4	D5	Number of Splines	Nut
MB 00	10	8,5	3	1,0	3	13,5	21	9	KM 00
MB 01	12	10,5	3	1,0	3	17	25	9	KM 01
MB 02	15	13,5	4	1,0	4	21	28	13	KM 02
MB 03	17	15,5	4	1,0	4	24	32	13	KM 03
MB 04	20	18,5	4	1,0	4	26	36	13	KM 04
MB 05	25	23,0	5	1,25	5	32	42	13	KM 05
MB 06	30	27,5	5	1,25	5	38	49	13	KM 06
MB 07	35	32,5	6	1,25	5	44	57	15	KM 07
MB 08	40	37,5	6	1,25	6	50	62	15	KM 08
MB 09	45	42,5	6	1,25	6	56	69	17	KM 09
MB 10	50	47,5	6	1,25	6	61	74	17	KM 10
MB 11	55	52,5	8	1,25	7	67	81	17	KM 11
MB 12	60	57,5	8	1,5	7	73	86	17	KM 12
MB 13	65	62,5	8	1,5	7	79	92	19	KM 13
MB 14	70	66,5	8	1,5	8	85	98	19	KM 14
MB 15	75	71,5	8	1,5	8	90	104	19	KM 15
MB 16	80	76,5	10	1,75	8	95	112	19	KM 16
MB 17	85	81,5	10	1,75	8	102	119	19	KM 17
MB 18	90	86,5	10	1,75	10	108	126	19	KM 18
MB 19	95	91,5	10	1,75	10	113	133	19	KM 19
MB 20	100	96,5	12	1,75	10	120	142	19	KM 20
MB 21	105	100,5	12	1,75	12	126	145	19	KM 21
MB 22	110	105,5	12	1,75	12	133	154	19	KM 22
MB 23	115	110,5	12	2,0	12	137	159	19	KM 23
MB 24	120	115,0	14	2,0	12	138	164	19	KM 24
MB 25	125	120,0	14	2,0	12	148	170	19	KM 25
MB 26	130	125,0	14	2,0	12	149	175	19	KM 26
MB 27	135	130,0	14	2,0	14	160	185	19	KM 27
MB 28	140	135,0	16	2,0	14	160	192	19	KM 28
MB 29	145	140,0	16	2,0	14	172	202	19	KM 29
MB 30	150	145,0	16	2,0	14	171	205	19	KM 30
MB 31	155	147,5	16	2,5	16	182	212	19	KM 31
MB 32	160	154,0	18	2,5	16	182	217	19	KM 32
MB 33	165	157,5	18	2,5	16	193	222	19	KM 33
MB 34	170	164,0	18	2,5	16	193	232	19	KM 34
MB 36	180	174,0	20	2,5	18	203	242	19	KM 36
MB 38	190	184,0	20	2,5	18	214	252	19	KM 38
MB 40	200	194,0	20	2,5	18	226	262	19	KM 40

Super Precision Bearings for Machine Tool Applications



NSK Super Precision Bearings

Product Range

Several types of super precision bearings are available from NSK, including the ROBUST™ series of high performance bearings, the special series of bearings for unique and specialised applications, and the standard series bearings.



Standard Series

High Precision Angular Contact Ball Bearings

Basic NSK super precision bearings manufactured to conform to ISO standards.

- › 70xx, 72xx, 79xx series
- › Three types of contact angle: 15° (C), 25° (A5), 30° (A)
- › Two types of cage design: Select either phenolic (TR) or polyamide (TYN), depending on application requirements
- › Two types of ball material: Steel and Ceramic (SN24)



ROBUST™ Series; Standard Series

Ultra High-Speed Single Row Cylindrical Roller Bearings

High performance cylindrical bearings designed for ultra high speed applications, such as machining center spindles.

- › Two types of cage material: Brass (MR)¹⁾ and PEEK resin (TP)
- › Three types of roller material: Steel, SHX and Ceramic
- › Ultra high speed ROBUST RXH design can be used up to 3 million $d_m N$.

¹⁾ MR cage is used in the standard series



ROBUST™ Series BNR, BER Series

Ultra High-Speed Angular Contact Ball Bearings

High performance bearings developed for high speed operation with low temperature rise. Suitable for ultra high precision machining applications, and ultra high speed applications.

- › Two types of contact angle: 18° (BNR), 25° (BER)
- › Two types of ball material: Steel (S type) and Ceramic (H & X type)
- › Two types of cage design: Select either phenolic (T) or polyamide (TYN), depending on application requirements
- › ROBUST series also can be used for ultra high speed applications of over 3 million $d_m N$



Standard Series High Rigidity Series

Double Row Cylindrical Roller Bearings

Designed to deliver high rigidity in high speed applications such as lathe spindles.

- › Two types of cage material: Brass (MB), PPS resin (TB)
- › Standard specification E44: Outer ring oil holes and groove



ROBUST™ Series; BAR, BTR Series

High-Speed Angular Contact Thrust Ball Bearings

High rigidity thrust bearings for lathe applications.

- › Two types of contact angle: 30° (BAR), 40° (BTR)
- › Two types of ball material: Steel (S type) and Ceramic (H type)



Special Series for Machine Tool Applications

Angular Contact Thrust Ball Bearings for Ball Screw Support

High rigidity thrust bearings designed specifically for ball screw support applications in machine tools.

- › Contact Angle: 60°
- › Can be universally matched to any required rigidity specification or life cycle
- › A pre-greased line using special grease is also available
- › A new series is available, supplied with contact seals and waterproof grease



BGR Series

Ultra High Precision Angular Contact Ball Bearings

High Performance bearings developed specifically for internal grinding or high speed motor applications under spring preload.

- › Bore size range: ø6–25 mm, contact angle: 15°
- › Non separable type
- › Universal combinations (DU and SU)
- › Two types of ball material: Steel (S type) and Ceramic (H and X type)



Special Series for Injection Moulding Machines

Angular Contact Thrust Ball Bearings for Ball Screw Support

The high load capacity design delivers five times the life expectancy compared to ball screw support bearings for machine tool applications of a similar size. The number of rows can also be reduced.

- › Easier handling than tapered roller bearings or thrust spherical roller bearings as a result of non-separable configuration
- › Optimum ball bearing design results in lower rotational torque
- › Can be universally matched to any required rigidity specification or life cycle



Special Series

Sealed Angular Contact Ball Bearings

Pre greased and sealed to reduce handling problems. Suitable for maintenance of machine tool spindles.

- › Standard series super precision angular contact ball bearings
- › ROBUST™ series high speed angular contact ball bearings
- › Bore size range: ø30–100 mm in ISO series 10 and 19 (70xx and 79xx)



Special Series

High Precision Deep Groove Ball Bearings

Suitable for high speed and high precision motors.

- › Three types of cage: Ball guided polyamide cage (T1X, TYA) and inner ring guided phenolic cage (T), selection depends on the application
- › Suitable for silent or low vibration operation

Thrust Angular Contact Ball Bearings

100	BAR	10	S	TYN	DB	L	P4A	
								Precision Class P4A: ISO Class 4, O.D. is Special P2A: ISO Class 2, O.D. is Special
								Preload L: Standard Preload EL: Standard Preload for High Speed Applications CP: Special Preload CA: Special Axial Clearance
								Combination DB: Back to Back Duplex
								Retainer TYN: Polyamide cage
								Material S: Steel Ball H: Ceramic Ball
								Dimension Series 10X: ISO-series 10 (bore & outer diameter but NSK specific width) to be arranged with NN30XX series
								Bearing Type BAR: 30° Contact Angle BTR: 40° Contact Angle
								Bearing Bore Diameter (mm)

Thrust Angular Contact Ball Bearings

100	TAC	20X	PN7	+L	C6		
							Preload Class C6: Standard Preload for Grease Lubrication C7: Standard Preload for Oil Lubrication
							Spacer (Inner Ring) Precision Class PN7: ISO Class 4, O.D. is Special
							Dimension Series 20X, 20D: to be combined with NN30 series 29D: to be combined with NN39 and NN49 series
							Bearing Type Bearing Bore Diameter (mm)

Ball Screw Support Bearings

30	TAC	62	B	DDG	SU	C10	PN7B	
								Precision Class PN7A: Standard Accuracy (Equivalent to ISO Class 4) PN7B: Special Accuracy (Bore diameter and OD are exclusive to NSK. Equivalent to ISO Class 4. For SU arrangement only.)
								Preload C10: Metric Series C11: Inch Series
								Mounting Configuration SU: Single Universal DU: Duplex Universal DB, DF, DT: Duplex Arrangement DBD, DFD, DTD, DUD: Triplex Arrangement DBB, DFF, DBT, DFT, DTT, QU: Quad Arrangement
								Seal Symbol No symbol: Open type DDG: Low friction contacting seal
								Internal Design B: High Capacity & Higher Speed (Replaces "A" type)
								Bearing O.D.¹⁾ (mm)
								Bearing Type: Bearing Bore¹⁾ (mm)

Cylindrical Roller Bearings

NN	3	0	17	MB	KR	E44	CCO	P4
								Precision Class P2: ISO Class 2 P4: ISO Class 4
								Radial Clearance CC1: Standard clearance for cylindrical bore ²⁾ CCO: Standard clearance for tapered bore ³⁾ CCG: Special radial clearance
								Lubrication E44: Outer ring with machined lubrication groove and holes (Double Row Only)
								Bore Configuration KR: Ultra Precision Tapered Bore (1:12) Blank symbol: Cylindrical Bore
								Retainer MB: Roller guided machined brass cage (Double Row) TB: Roller guided PPS resin cage (Double Row) TP: Outer ring guided PEEK resin cage MR: Roller guided machined brass cage (Single Row)
								Material RS: Bearing Steel (SUJ2) (rings and rolling elements) ⁴⁾ RX: Heat Resistant Steel (SHX) (rings and rolling elements) ⁴⁾ RXH: Heat Resistant Steel (SHX) for rings and ceramic rolling elements No symbol: SUJ2 steel
								Bore code Diameter Series Width Series
								Cylindrical Roller Designator NN: Double Row, Inner Ring Guided Rollers N: Single Row, Inner Ring Guided Rollers

¹⁾ For inch series bearings, the fractional portion of the size is omitted.

²⁾ CC1 clearance. Matched clearance range greater than CCO. While not the standard, this clearance is most popular in the field.

³⁾ CCO clearance (NSK's recommended clearance) CCO clearance range less than CC1. This range overlaps with the upper values of CC9 and lower values of CC1 as this clearance is easy for customers to target this range, it is the preferred clearance offered for CRB with taper bore.

⁴⁾ only valid for one-row bearings.

Super Precision Angular Contact Bearings for Machine Tools

Conventional Type 72, 70, 79 Series

70	16	A5	TR	V1V	DU	L	P3	
								Precision Class P4: ISO Class 4 (ABEC7) P3: Dimensions - ISO Class 4 Running Accuracy: ISO Class 2 P2: ISO Class 2 (ABEC9)
								Preload L: Light M: Medium H: Heavy Gxx: Preload in Kgf (G5=5 Kgf) CPxx: Median Preload in Microns (CP10=10µm) CAxx: Median Axial Clearance in Microns (CA15=15µm)
								Mounting Configuration SU: Single Universal DU: Duplex Universal DB, DF, DT: Duplex Arrangement DBD, DFD, DTD, DUD: Triplex Arrangement DBB, DFF, DBT, DFT, DTT, QU: Quad Arrangement
								Seal No symbol: Open type V1V: Non contact rubber seal
								Retainer TR: Phenolic Cage TYN: Polyamide cage
								Material No symbol: Bearing Steel (SUJ2) SN24: Ceramic Balls
								Contact Angle A: 30° A5: 25° C: 15°
								Bore Diameter Designator Bearing Series

ROBUST™ Series, High-Speed Type

80	BER	10	S	T	V1V	SU	EL	P3
								Precision Class P4: ISO Class 4 (ABEC7) P3: Dimensions - ISO Class 4 Running Accuracy: ISO Class 2 P2: ISO Class 2 (ABEC9)
								Preload EL: Extra Light L: Light Gxx: Preload in Kgf (G5 = 5 Kgf) CPxx: Median Preload in Microns (CP10=10µm) CAxx: Median Axial Clearance in Microns (CA15=15µm)
								Mounting Configuration SU: Single Universal DU: Duplex Universal DB, DF, DT: Duplex Arrangement DBD, DFD, DTD, DUD: Triplex Arrangement DBB, DFF, DBT, DFT, DTT, QU: Quad Arrangement
								Seal No symbol: Open type V1V: Non contact rubber seal
								Retainer T: Phenolic Cage TYN: Polyamide Cage T42: PEEK Cage
								Dimension Series 10: Same bore diameter, outside diameter, and width as the 70 series 19: Same bore diameter, outside diameter, and width as the 79 series
								Material S: Steel Ball H: Ceramic Balls X: SHX rings, ceramic balls
								Bearing Type BNR: 18° Contact Angle BER: 25° Contact Angle BGR: 15° Contact Angle
								Nominal Bore Diameter

Angular Contact Ball Bearings Combinations Available

	DB	DF	DT	DBD	DBB
Load stiffness	↔	↔	⇒	↔	↔
Moment stiffness	●	○	□	●	●
Speed capability	○	●	●	□	○
Heat generation	○	●	●	□	○
Stiffness	○	○	□	○	●

Excellent = ●
 Very good = ○
 Good = ○
 Fair = □
 One direction only = ⇒
 Two directions = ↔

Misalignment of inner- and outerring

NSK offers “universal” bearings, **SU** or **DU**, that can be used to create various angular contact ball bearing arrangements. A universal angular contact ball bearing is one with the same offset ground on both front and back faces. Reference **Fig. 1**, ($f=b$). This offset relates directly to the bearing’s stringent preload control and enables universal bearings to be combined or form back to back (**DB**, **DBD**, **DBB**) or face to face (**DF**, **DFD**, **DF**) sets.

Fig. 1

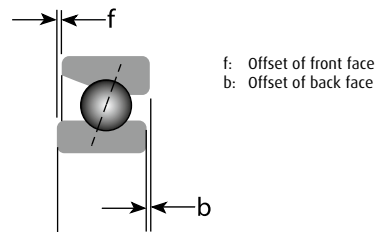

f: Offset of front face
b: Offset of back face

High Point of Radial Runout

The high point of radial runout is indicated by a small circle or burnished spot on the inner ring face (**Fig. 2a**) and by a 'V' line on the outside diameter of the outer ring (**Fig. 2b**). The bearings can then be mounted with these marks axially aligned with each other and opposed to the shaft or housing eccentricities in order to minimise assembled runout.

Fig. 2a

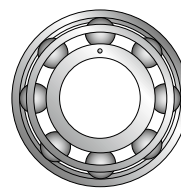

Fig. 2b



Features

- › State-of-the art preload control
- › High Point of Eccentricity marked on inner and outer rings
- › Bearing and box marked with actual bore, OD, and width deviation from nominal (units are microns μm), see **Figures 3a**, **3b** and **3c**
- › High performance phenolic cage

Fig. 3a

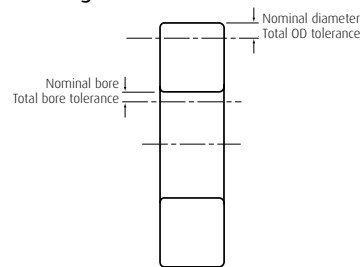

Fig. 3b

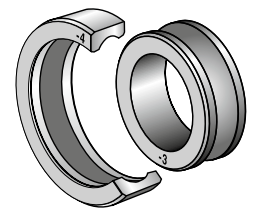
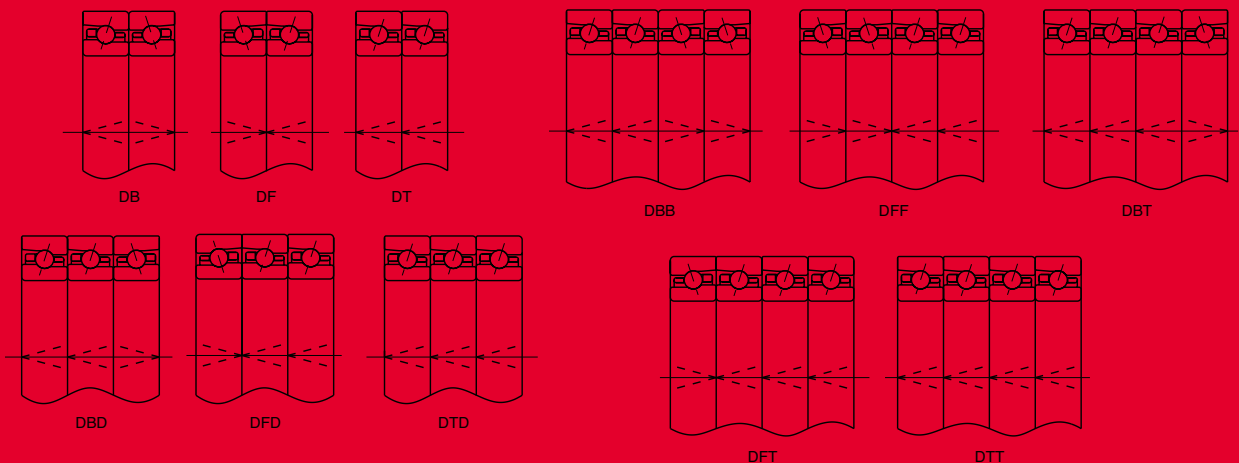

Fig. 3c

7014CTRDULP3	
R	5 D: -4
	d: -3
	C: -20

D = Outside Diameter
d = Bore Diameter
C = Width

Combination Mark & Matching Method for Universal Combination Bearings



Grease Packing for High Speed Bearings

The Recomendable Grease Quantities for High-speed Spindle Bearings

Bore Numbers	Nominal Bearing Bore (mm)	Angular Contact Ball Bearings 15% of internal space (NSK-Code: X)				Cylindrical Roller Bearing 10% of internal space (NSK-Code: X)			
		BNR19, BGR19, BER19, 79XX	BGR10 70XX	BGR02 72XX	BNR10, BAR10 BER10, BTR10	NN49	NN39	NN30	N10
5	5	-	-	0,03	-	-	-	-	
6	6	-	0,04	0,07	-	-	-	-	
7	7	-	0,07	-	-	-	-	-	
8	8	-	0,12	0,10	-	-	-	-	
00	10	0,06	0,13	0,16	-	-	-	-	
01	12	0,06	0,14	0,23	-	-	-	-	
02	15	0,11	0,18	0,29	-	-	-	-	
03	17	0,13	0,24	0,41	-	-	-	-	
04	20	0,23	0,44	0,68	-	-	-	-	
05	25	0,27	0,52	0,85	-	-	0,4	-	
06	30	0,31	0,69	1,2	0,58	-	-	0,6	0,4
07	35	0,48	0,98	1,7	0,78	-	-	0,8	0,6
08	40	0,75	1,2	2,1	0,92	-	-	1,0	0,7
09	45	0,83	1,5	2,6	1,2	-	-	1,3	1,0
10	50	0,91	1,6	3,0	1,2	-	-	1,4	1,1
11	55	1,1	2,4	3,9	1,7	-	-	2,0	1,5
12	60	1,2	2,6	4,8	1,8	-	-	2,1	1,6
13	65	1,3	2,6	5,7	1,9	-	-	2,2	1,6
14	70	2,1	3,6	6,5	2,8	-	-	3,2	2,4
15	75	2,3	3,6	7,0	2,9	-	-	3,5	2,5
16	80	2,4	5,1	8,7	3,8	-	-	4,7	3,5
17	85	3,5	5,3	11	4,0	-	-	4,9	3,7
18	90	3,6	6,6	13	5,5	-	-	6,5	4,5
19	95	3,6	6,8	16	5,7	-	-	6,6	4,7
20	100	4,9	7,2	19	6,1	5,4	4,5	6,8	4,9
21	105	5,1	9,0	23	7,6	5,6	4,6	9,3	5,9
22	110	5,2	12	27	9,1	5,7	4,8	11	7,5
24	120	7,9	12	31	9,8	8,4	6,5	12,5	8,1
26	130	9,0	18	34	15	11	8,5	18	12,4
28	140	9,9	20	42	17	12	9,3	20	12,9
30	150	14	25	53	22	24	14	23	-
32	160	16	34	-	26	20	15	29	-

Units: cm³/row

The grease quantity of "xxTAC20(29)X(D)" should be same as the double row cylindrical roller bearing's, which is assembled with the bearing together.

Characteristics of different greases

Name	Manufacturer	Thickener	Base Oil	Viscosity of base oil (mm ² /s)	Dropping Point (°C)	Temperature Range (°C)	Notes
MTE	NSK	Barium Complex	Ester Oil	20	200	-30~+120	Applicable for high speed cylindrical roller bearings and high speed spindles
MTS	NSK	Urea	Mixed Synthetic Oil	22	220	-40~+130	Applicable for high speed spindles

Packing method for ball bearings (Fig. 1)

1. Pack grease evenly between the balls. If an outer ring guided cage is used, such as a phenolic resin cage, apply a light coating of grease on the guided surface.
2. Rotate the bearing by hand to spread grease evenly on the surfaces of the raceway, ball, and cage.

Packing method for cylindrical roller bearings (Fig. 2)

1. Coat about 80% of the grease amount evenly on roller rolling surface. Avoid putting too much grease on the cage bore. Grease on the cage bore is difficult to disperse during the running in period, which can result in a rapid rise in temperature or a long running in period.
2. Coat roller surfaces with a thin film of grease, including the roller end faces, roller cage contact points, and along the face edges of each cage pocket.
3. Using the remaining 20% of grease, apply a thin film of grease to the raceway surface of the outer ring.

Fig. 1:
Grease Packed Angular Contact Ball Bearing







Fig. 2:
Grease Packed Cylindrical Roller Bearing



Super Precision Bearings Interchange Guide

Interchange Guide for Precision Angular Contact Bearings

Standard Design	ISO Series	NSK	SKF	SNFA	Fafnir	FAG
	19	79xxA5(V1V)	719xxACD	SEBxxxxx3	3xx 93xxWI	B719xxE (2RSD)
	10	70xxA5(V1V)	70xxACD	SEBxxxxx3	3xx 91xxWI	B70xxE (2RSD)
	02	72xxA5	72xxACD	E2xxxxx3	3xx 21xxWI	B72xxE (2RSD)
	19	79xxA5SN24(V1V)	719xxACD/HC	SEBxx/NSxxx3	3xx C93xxWI	HCB719xxE (2RSD)
	10	70xxA5SN2(V1V)	70xxACD/HC	EXxx/NSxxx3	3xx C91xxWI	HCB70xxE (2RSD)
High Speed Design						
	19	xxBER 19(V1V) S	719xxACE	VEBxxxxx3	3xx 93xxHX(VV)	HS(S)719xxE
	10	xxBER 10(V1V) S	70xxACE	VEExx(/S)xxx3	3xx 91xxHX(VV)	HS(S)70xxE
	19	xxBER 19(V1V) H	719xxACE/HC	VEBxx/NSxxx3	3xx C93xxHX(VV)	HC(S)719xxE
	10	xxBER 10(V1V) H	70xxACE/HC	VEExx(/S)/NSxxx3	3xx C91xxHX(VV)	HC(S)70xxE
	19	xxBER 19(V1V) X	-	VEBxxXNxxx3	-	XC(S)719xxE
	10	xxBER 10(V1V) X	-	VEExx(/S)/XNxxx3	-	XC(S)70xxE

Example of 25 degrees contact angle

 Steel balls

 Ceramic balls

 Steel balls sealed

 Ceramic balls sealed

 Special material rings/
Ceramic balls (Sealed)

Symbols in brackets show seal designation when available. **Items in red are the manufacturers identifiers of particular parameters**

Interchange Guide for Precision Thrust Bearings

Thrust bearings for spindle	NSK	SKF	SNFA	Fafnir	FAG
Applications Contact Angle					
30°	xx BAR	BTMxx A/DB	-	-	-
40°	xx BTR	BTMxx B/DB	-	-	-
60°	xx TAC	2344xx	-	-	2344xx

Interchange Guide for Precision Ball Screw Support Bearings

Series	NSK	SKF	SNFA	Fafnir	FAG
Non-ISO Metric ¹⁾	30TAC62B	BSD 3062C	BS 3062	MM 30BS62	BSB 030062
ISO Metric ²⁾	BSB 2030	BSA 206C	BS 230	-	760230
Inch ³⁾	BSB 093	BDAB 634201C	-	MM 9308W1ZH	-

¹⁾Bore Diameter 30; OD - Ø 62; Width 15 ²⁾Bore Diameter 30; OD - Ø 62; Width 16 ³⁾Bore Diameter 23,838; OD - Ø 62; Width 15,875

Interchange Guide for Precision Cylindrical Roller Bearings

Standard Design Construction	NSK	SKF	FAG
	NN39xx(KR)	-	-
	NN30xx(KR)	NN30xx(K)	NN30xx(K)
	NN49xx(KR)	-	-
	NNU49xx(KR)	NNU49xx(K)	NNU49xx(K)
	N10xx(KR)	N10xx(K)	N10xx(K)
High Speed Design Construction			
	Steel Rollers & Rings	N10xxRS(KR)	-
	Ceramic Rollers & Special Steel Rings	N10xxRXH(KR)	N10xxHC5(K)*
	Special Steel Rollers & Rings	N10xxRX(KR)	

* Normal steel rings used only

This interchange should be used as a guideline only, as manufacturers' designations may change without notice.

Catalogue Information

This publication reflects our standard bearing manufacturing program, corresponding to the most important part of the applications that are met in various industries.

NSK manufactures one of the widest ranges of bearings available in the market, including specific bearings for various industry sectors. NSK is market leader in Mounted-Units and Plummer Blocks manufacturing.

You can download more sector and product specific catalogues from our website: www.nskeurope.com



Serie NSK	Page	Serie NSK	Page	Serie NSK	Page	Serie NSK	Page	Serie NSK	Page
100	*	3200B-ZZ	150	BL300NR	139	NCF2900	*	SF-EC	*
600	124	3300B	150	BL300Z	124	NCF3000	*	SF-HLT	*
620	124	3300B-2RS	150	BL300ZNR	124	NF200 oder LRJA	168	SFT	*
630	124	3300B-ZZ	150	BL300ZZ	124	NF300 oder MRJA	168	SFT1000K	*
680	124	36/DF140-1.1/2	*	BL300ZZNR	124	NJ1000	168	SFT1000KG	*
690	124	36/PDNF140-1.1/2	*	BT	*	NJ200 oder LLRJA	168	SFT-A	*
1100	*	4200B	140	BT-A	*	NJ2200	168	SFT-DEC	*
1200	160	4300B	140	BT-DEC	*	NJ2300	168	SFT-EC	*
1300	160	5/PDNF150-1.3/4	*	BT-EC	*	NJ300 oder MMRJA	168	SFT-HLT	*
2200	160	6000DDU	124	BT-EC + BTHF	*	NJ400	168	SL	*
2300	160	6000DU	124	BTHF	*	NLJ	160	SLC	*
3200	150	6000-H-20	*	CNP	*	NMJ	160	SLC1000K	*
3300	150	6000-H-20DDU	*	CS200LLU	*	NN3000	259	SLC-A	*
4200	140	6000-H-20ZZ	*	DNF245/10	*	NNCF4800	*	SLC-DEC	*
4300	140	6000N	124	DNF245/10G	*	NNCF4900	*	SLC-EC	*
5200	231	6000NR	124	E, EN, L	*	NNCF5000	*	SL-DEC	*
5300	150	6000VV	124	FC	*	NNU4900	*	SL-EC	*
6000	124	6000Z	124	FC-A	*	NP	*	SLFE	*
6200	124	6000ZNR	124	FC-DEC	*	NP1000K	*	SLFE-A	*
6300	124	6000ZZ	124	FC-EC	*	NP1000KG	*	SLFE-DEC	*
6400	124	6000ZZNR	124	FR	*	NP-A	*	SLFE-EC	*
6800	124	600DD	124	FT	*	NP-DEC	*	SLFL	*
6900	124	600ZZ	124	H	249	NP-EC	*	SLFL-A	*
7000	142	6200DDU oder LJ-2R	S 124	HA	249	NP-HLT	*	SLFL-DEC	*
7200	142	6200DU oder LJ-RS	124	HE	249	NU1000	168	SLFL-EC	*
7300	142	6200-H-20	*	HJ	*	NU200 oder LLRJ	168	SLFT	*
11200	*	6200-H-20DD	*	HR30200	185	NU2200	168	SLFT-A	*
11300	*	6200-H-20ZZ	*	HR30300	185	NU2300	168	SLFT-DEC	*
16000	124	6200N oder LJ-N	124	HR30300DJ	185	NU300 oder MMRJ	168	SLFT-EC	*
16100	124	6200NR oder LJ-NR	124	HR32000XJ	185	NU400	168	SNP	*
21300	217	6200RS	124	HR32200	185	NUP1000	168	SNP1000K	*
22200	217	6200VV	124	HR32300	185	NUP200 oder LLRJB	168	SNP-A	*
22300	217	6200Z oder LJ-Z	124	HR32900	185	NUP2200	168	SNP-DEC	*
23000	217	6200ZNR	124	HR33000	185	NUP2300	168	SNP-EC	*
23100	217	6200ZZ oder LJ-ZZ	124	HR33100	185	NUP300 oder MMRJB	168	ST	*
23200	217	6200ZZNR	124	HR33200	185	NUP400	168	ST1000K	*
23300	217	620DD	124	HR33200	185	PDF150/9	*	ST-A	*
23900	217	620ZZ	124	J1000GCR	*	PDF150/9G	*	ST-DEC	*
24000	217	6300DDU oder MJ-2RS	124	KLNJ	124	PDF150-1.15/16	*	ST-EC	*
24100	217	6300DU oder MJ-RS	124	KLNJ-2RS	124	PDF155/12	*	T1000DECG	*
29200	231	6300N oder MJ-N	124	KLNJ-ZZ	124	PDF155/12G	*	T1000G	*
29300	231	6300NR oder MJ-NR	124	KLNJ-Z	124	PDF155-2.3/16	*	TFC-DEC	*
29400	231	6300VV	124	LDJK	*	PDF155-2.3/16G	*	TLPB-DEC	*
51100	231	6300Z oder MJ-Z	124	LFTC-A	*	PDF240/9	*	TNP-DEC	*
51200	231	6300ZNR	124	LFTC-EC	*	PDNF140-1.3/16	*	TSCH-DEC	*
51300	231	6300ZZ oder MJ-ZZ	124	LJ	124	PDNF145-45	*	TSCHB-DEC	*
51400	231	6300ZZNR	124	LJ-2RS	124	PDNF145-45G	*	TSF-DEC	*
52200	231	630DD	124	LJ-ZZ	124	PDNF150/9	*	TSFT-DEC	*
52300	231	630ZZ	124	LJ-N	124	PDNF150/9G	*	TSLFE-DEC	*
52400	231	6800DD	124	LJ-NR	124	PDNF150-1.15/16	*	TSLFL-DEC	*
53200	231	6800-H-20	*	LJ-RS	124	PDNF150-1.15/16G	*	TSLFT-DEC	*
53300	231	6800-H-20ZZ	*	LJT	142	PDNF155/12	*	TSNP-DEC	*
53400	231	6800NR	124	LJ-Z	124	PDNF155-2.3/16	*	TST-DEC	*
54200	231	6800VV	124	LLRJ	168	PDNF240/8	*	U200	*
54300	231	6800ZZ	124	LPB	*	PDNF240/9	*	U300	*
54400	231	6800ZZNR	124	LPB-A oder ASPP200	*	PDNF240/9G	*	UC200	*
1/PDNF240/8G	*	6900DD	124	LPB-DEC	*	PDNF245/10	*	UC300	*
1/PDNF240/9G	*	6900-H-20	*	LPB-EC	*	PDNF245/10G	*	UCF200	*
1000DECG	*	6900-H-20DD	*	LPBR	*	PDNF250/9	*	UCF300	*
1000DECGFS	*	6900-H-20ZZ	*	LPBR-EC	*	PNP-CR	*	UCFC200	*
1000DECGHLT	*	6900NR	124	LRJ	168	PSF-CR	*	UCFC300	*
1000G	*	6900VV	124	LT-(B)	*	PSF-CR	*	UCFCX00	*
1000GFS	*	6900ZZ	124	MDJK	*	PSF-CR	*	UCFH200	*
1000KG	*	6900ZZNR	124	MFC	*	PSFT-CR	*	UCFL200	*
1100CG	*	7200 oder LJT	142	MJ	124	QJ200 oder QJL	154	UCFL300	*
1100DEC	*	7200B	142	MJ-2RS	124	QJ200LOC	*	UCFLX00	*
1200oder NLJ	160	7300 oder MJT	142	MJ-ZZ	124	QJ200LOC oder QJL-LOC	*	UCFX00	*
1200ECG	*	7300B	142	MJ-N	124	QJ300 oder QJM	154	UCHB200	*
1200G	*	AEL20 0	*	MJ-NR	124	QJ300LOC oder QJM-LOC	*	UCP200	*
1200K	160	AELFD200	*	MJ-RS	124	QJL	154	UCP300	*
1300 oder NMJ	160	AELPF200	*	MJT	142	QJL-LOC	*	UCPX00	*
1300EC	*	AELPFL200	*	MJ-Z	124	QJM	154	UCT200	*
1300K	160	AELPP20 0	*	MMRJ	*	QJM-LOC	*	UCT300	*
1726200-2RS	*	AH	249	MP	*	R	*	UCTX00	*
2/DF240/8	*	AHX	249	MRJ	168	SCH	*	UCUP200	*
2/DF240/9	*	AN / KM	249	MSC	*	SCH/SCHB	*	UCUP200	*
2/DNF140-1.3/16	*	AS200	*	MSF	*	SCH1000K	*	UCX00	*
2/DNF240/7	*	ASFD200	*	MSFT	*	SCH-A	*	UEL200	*
2/DNF240/8	*	ASPF200	*	MST	*	SCHB-A	*	UELF200	*
2/DNF240/9	*	ASPFL200	*	MT	231	SCHB	*	UELFC200	*
2200-2RS	160	ASPP200	*	N1000	168	SCH-DEC	*	UELFL200	*
2200K	160	AW	249	N200 oder LRJ	168	SCHB-DEC	*	UELP200	*
2300-2RS	160	BL200	124	N2200	168	SCH-EC	*	UELT200	*
2300K	160	BL200Z	124	N2300	168	SCHB-EC	*	UK200	*
28/DNF245-45G	*	BL200ZNR	124	N300 oder MRJ	168	SF	*	XLJ	124
28/PDNF145-1.1/2	*	BL200ZZ	124	N400	168	SF1000K	*	XLRJ	168
3200B	150	BL200ZZNR	124	NCF1800	*	SF-A	*	XLT	231
3200B-2RS	150	BL300	124	NCF2200	*	SF-DEC	*		

* Consult NSK!

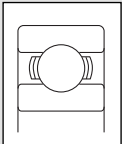

B

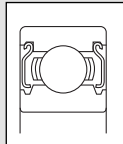

B1

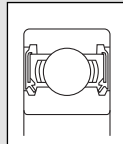

B2

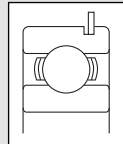

B3

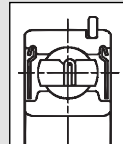

B4

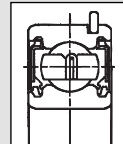

B5

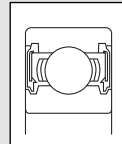

B6

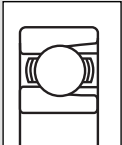

C

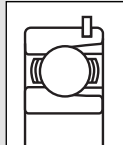

C1

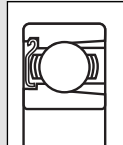

C2

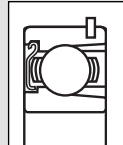

C3

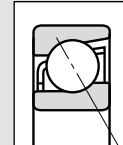

D

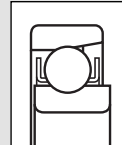

D1

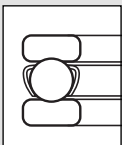

E

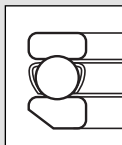

E1

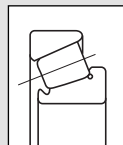

F

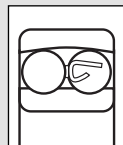

G

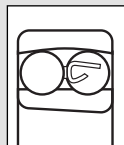

G1

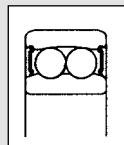

G2

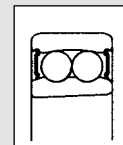

G3

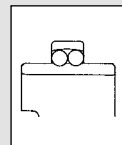

G4

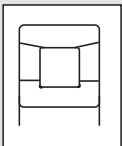

H

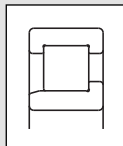

H1

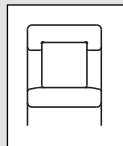

H2

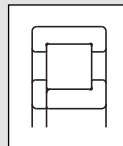

H3

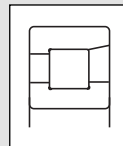

H4

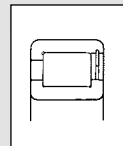

H5

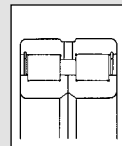

H6

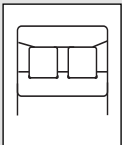

I

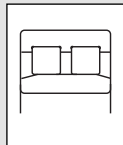

I1

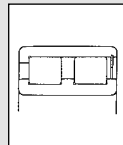

I2

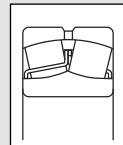

K

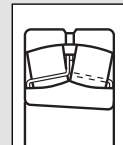

K1

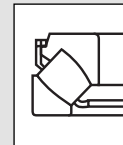

O

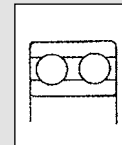

L

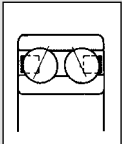

M

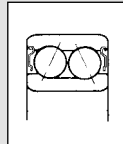

M1

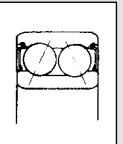

M2

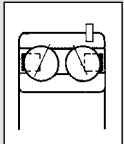

M3

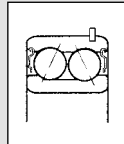

M4

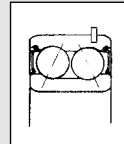

M5

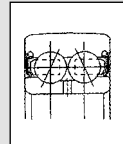

M6

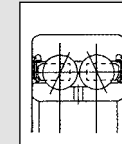

M7

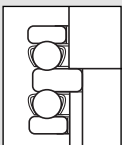

N

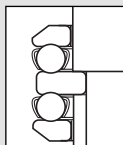

N1

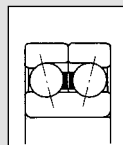

P

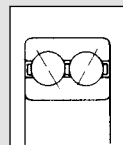

P1

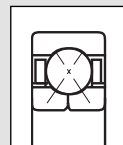

P2

NSK Sales Offices – Europe, Middle East and Africa

UK

NSK UK Ltd.
Northern Road, Newark
Nottinghamshire NG24 2JF
Tel. +44 (0) 1636 605123
Fax +44 (0) 1636 643276
info-uk@nsk.com

France & Benelux

NSK France S.A.S.
Quartier de l'Europe
2, rue Georges Guynemer
78283 Guyancourt Cedex
Tel. +33 (0) 1 30573939
Fax +33 (0) 1 30570001
info-fr@nsk.com

Germany, Austria, Switzerland, Nordic

NSK Deutschland GmbH
Harkortstraße 15
40880 Ratingen
Tel. +49 (0) 2102 4810
Fax +49 (0) 2102 4812290
info-de@nsk.com

Italy

NSK Italia S.p.A.
Via Garibaldi, 215
20024 Garbagnate
Milanese (MI)
Tel. +39 02 995 191
Fax +39 02 990 25 778
info-it@nsk.com

Middle East

NSK Bearings Gulf Trading Co.
JAFZA View 19, Floor 24 Office 2/3
Jebel Ali Downtown,
PO Box 262163
Dubai, UAE
Tel. +971 (0) 4 804 8205
Fax +971 (0) 4 884 7227
info-me@nsk.com

Poland & CEE

NSK Polska Sp. z o.o.
Warsaw Branch
Ul. Migdałowa 4/73
02-796 Warszawa
Tel. +48 22 645 15 25
Fax +48 22 645 15 29
info-pl@nsk.com

Russia

NSK Polska Sp. z o.o.
Russian Branch
Office 1 703, Bldg 29,
18th Line of Vasilievskiy Ostrov,
Saint-Petersburg, 199178
Tel. +7 812 3325071
Fax +7 812 3325072
info-ru@nsk.com

South Africa

NSK South Africa (Pty) Ltd.
25 Galaxy Avenue
Linbro Business Park
Sandton 2146
Tel. +27 (011) 458 3600
Fax +27 (011) 458 3608
nsk-sa@nsk.com

Spain

NSK Spain, S.A.
C/ Tarragona, 161 Cuerpo Bajo
2ª Planta, 08014 Barcelona
Tel. +34 93 2892763
Fax +34 93 4335776
info-es@nsk.com

Turkey

NSK Rulmanları Orta Doğu Tic. Ltd. Şti
19 Mayıs Mah. Atatürk Cad.
Ulya Engin İş Merkezi No: 68/3 Kat. 6
P.K.: 34736 - Kozyatağı - İstanbul
Tel. +90 216 4777111
Fax +90 216 4777174
turkey@nsk.com

Please also visit our website: www.nskeurope.com
Global NSK: www.nsk.com

